



Accredited with NAAC **A** Grade

12-B Status from UGC

Basic Computer Skills

CENTRE FOR DISTANCE AND ONLINE EDUCATION



Accredited with NAAC **A** Grade

12-B Status from UGC

BASIC COMPUTER SKILLS

REVIEW COMMITTEE

Prof. Dr. Manjula Jain
Dean (Academics)
Teerthanker Mahaveer University (TMU)

Prof. Dr. Vipin Jain
Director, CDOE
Teerthanker Mahaveer University (TMU)

Prof. Amit Kansal
Associate Dean (Academics)
Teerthanker Mahaveer University (TMU)

Prof. Dr. Manoj Rana
Jt - Director, CDOE
Teerthanker Mahaveer University (TMU)

BLOCK PREPARATION

Ms. Anupma Verma
Department of Humanities
Centre for Distance and Online Education (CDOE)
Teerthanker Mahaveer University (TMU)

Secretarial Assistance and Composed By:

Mr. Namit Bhatnagar

COPYRIGHT : Teerthanker Mahaveer University
EDITION : 2024 (Restricted Circulation)
PUBLISHED BY : Teerthanker Mahaveer University, Moradabad

CONTENTS

Unit 1:	Computer Fundamentals	1
Unit 2:	Introduction to Data Representations	21
Unit 3:	Memory	35
Unit 4:	Secondary Storage Devices	43
Unit 5:	MS Window	72
Unit 6:	Working with Windows Explorer	84
Unit 7:	Microsoft Word Introduction	108
Unit 8:	Microsoft Word-II	136
Unit 9:	MS Word: Additional Features	161
Unit 10:	Microsoft Excel	186
Unit 11:	Operations of MS Excel	209
Unit 12:	MS PowerPoint	237
Unit 13:	Internet	261
Unit 14:	Web Server Applications	286

SYLLABUS

Basic Computer Skills

This course imparts understanding of fundamental concepts of computers. To make students learn various office applications in theory as well as Practical. To provide students with the basic computer knowledge and skills required to obtain an understanding of computer hardware, software, networks.

Sr. No.	Topics
1.	Computer Fundamentals. Characteristics and Generation of Computers, Block diagram of Computer Data Representation: Binary Number System, Octal, Hexadecimal and their Conversion
2.	Memory: Types, Units of memory, RAM, ROM, Secondary storage devices - HDD, Flash Drives, Optical Disks: DVD I/O Devices - Keyboard, Mouse, LCDs, Scanner, Plotter, Printer and Latest I/O devices in market
3.	MS Windows: Desktop, My Computer, Files and folders using windows explorer; Control Panel, Searching Files and folders
4.	MS Word: Introduction, Environment, Help, Creating and Editing Word Document. Saving Document, Working with Text: Selecting, Formatting, Aligning and Indenting
5.	MS Word: Finding Replacing Text, Bullets and Numbering, Header and Footer, Working with Tables, Properties Using spell checker, Grammar, AutoCorrect Feature, Synonyms and Thesaurus
6.	MS Word: Graphics: Inserting Pictures, Clipart, Drawing Objects, Using Word Art. Setting page size and margins; Printing documents. Mail Merge Practical
7.	MS-Excel: Environment, Creating, Opening, and Saving Workbook. Range of Cells. Formatting Cells, Functions: Mathematical, Logical, Date, Time, Auto Sum
8.	MS-Excel: Formulas. Graphs: Charts. Types and Chart Tool Bar. Printing: Page Layout, Header and Footer Tab
9.	MS PowerPoint: Environment, Creating and Editing presentation, Auto content wizard, using built-in templates MS PowerPoint: Types of Views: Normal, Outline, Slide, Slide Sorter, Slide Show, Creating customized templates; formatting presentations Graphics: AutoShapes, adding multimedia contents, printing slides
10.	Internet: Basic Internet terms: Web Page, Website, Home page, Browser, URL, Hypertext, ISP, Web Server Applications: WWW, e-mail, Instant Messaging, Internet Telephony, Videoconferencing, Web Browser and its environment

Unit 1: Computer Fundamentals

CONTENTS

Objectives

Introduction

- 1.1 Characteristics of Computers
- 1.2 Evolution of Computers
- 1.3 Computer Generations
 - 1.3.1 First Generation (1942-1955)
 - 1.3.2 Second Generation (1955-1964)
 - 1.3.3 Third Generation (1964-1975)
 - 1.3.4 Fourth Generation (1975-1989)
 - 1.3.5 Fifth Generation (1989-Present)
- 1.4 Block Diagram of Computer
 - 1.4.1 Input Unit
 - 1.4.2 Storage Unit
 - 1.4.3 Memory size
 - 1.4.4 Output Unit
 - 1.4.5 Arithmetic Logical Unit
 - 1.4.6 Control Unit
 - 1.4.7 Central Processing Unit
- 1.5 Summary
- 1.6 Keywords
- 1.7 Self-Assessment Questions
- 1.8 Review Questions
- 1.9 Further Readings

Objectives

After studying this unit, you will be able to:

- Understanding and Introduction of computers
- Discussion of computer evolution
- Explanation the all generation of computers

Notes

- Understanding of block diagram of computers
- Understanding of memory and its type

Introduction

The word “computer” comes from the word “compute”, which means, “to calculate”. Hence, people usually use a computer to be a calculating device that can perform arithmetic operations at high speed. In fact, the original objective for inventing a computer was to create a fast calculating machine. However, more than 80% of work done by computers today is of non-mathematical or non-numerical nature. Hence, to define computer merely as a calculating device is to ignore over 80% of its functions.

More accurately, we can define a computer as a device that operates upon data. Data can be anything like bio-data, hence computer is used for short listing candidates for recruiting; marks obtained by students in when used for preparing results; details (name, age, sex, etc.) of passengers when used for or railway reservations: or number of different parameters when used for solving scientific problems, etc.

Hence, data comes in various shapes and sizes depending upon the type of computer application. A computer can and retrieves data as and when desired. The fact that computers process data is so fundamental that have started calling it a *data processor*.

The name data processor is more inclusive because modern computers not only compute in the usual sense but also perform other functions with data that flows to and from them. For example, data processors may gather data from various incoming sources, merge (process of mixing or putting together) them all, sort (process of arranging in some of sequence—ascending or descending) them in the desired order, and finally print them in desired format. Notice that none of these operations involves arithmetic computations in the usual sense but a computer is the most suitable device for performing them.



Did u know?

People usually consider a computer to be a calculating device that can perform arithmetic operations at high speed. It is also known as a data processor because it not only computes in the usual sense but also performs other functions with the data.

The activity of processing data using a computer is called *data processing*. Data processing consists of three sub-activities: capturing input data, manipulating the data, and managing output results. As used in data processing, information is data arranged in an order and form that is useful to people receiving it. Hence, *data is* raw material used as input to data processing and *information is* processed data obtained as output of data processing.

1.1 Characteristics of Computers

Increasing popularity of computers has proved that it is a very powerful and useful tool. The power and useful of this popular tool are mainly due to its following characteristics:

1. **Automatic.** An automatic machine works by itself without human intervention. Computers automatic machines because once started on a job, they carry out the job (normally without a human assistance) until it is finished. However, computers being machines cannot start themselves and cannot go out and find their own problems and solutions. We need to instruct a computer using coded instructions that specify exactly how it will do a particular job. Some of the other characteristics of computers (such as speed and accuracy) are because they are automatic and work on a problem without any human intervention.

2. **Speed.** A computer is a very fast device. It can perform in a few seconds, the amount of work that a human being can do in an entire year if he/she worked day and night and did nothing else. In other words, a computer can do in a few minutes what would take a man his entire life time while talking about the speed of a computer we do not talk in terms of seconds or even milliseconds (10^{-3}) but in terms of microseconds (10^6), nanoseconds (10^{-9}), and even picoseconds (10^{-12}). A powerful computer is capable of performing several billion (10^9) simple arithmetic operations per second.
3. **Accuracy.** In addition to being very fast, computers are very accurate. Accuracy of a computer is consistently high and the degree of its accuracy depends upon its design. A computer performs even calculation with the same accuracy. However, errors can occur in a computer. These errors are mainly due to human rather than technological weaknesses. For example, errors may occur due to imprecise thinking by a programmer (a person who writes instructions for a computer to solve a particular problem) or incorrect input data. We often refer to computer errors caused due to incorrect input data or unreliable programs as *garbage-in-garbage-out (GIGO)*.
4. **Diligence.** Unlike human beings, a computer is free from monotony, tiredness, and lack of concentration. It can continuously work for hours without creating any error and without grumbling. Hence, computers score over human beings in doing routine type of jobs that require great accuracy. If ten million calculations have to be performed, a computer will perform the last one with exactly the same accuracy and speed as the first one.
5. **Versatility.** Versatility is one of the most wonderful things about a computer. One moment it is preparing results of an examination, next moment it is busy preparing electricity bills, and in between, it may be helping an office secretary to trace an important letter in seconds. All that is required to change its talent is to slip in a new program (a sequence of instructions for the computer) into it. In brief, a computer is capable of performing almost any task, if the task can be reduced to a finite series of logical steps.
6. **Power of Remembering.** As a human being acquires new knowledge, his/her brain subconsciously selects what it feels to be important and worth retaining in memory. The brain relegates unimportant details to back of mind or just forgets them. This is not the case with computers. A computer can store and recall any amount of information because of its secondary storage (a type of detachable memory) capability. It can retain a piece of information as long as a user desires and the user can recall the information whenever required. Even after several years, a user can recall exactly the same information that he/she had stored in the computer several years ago. A computer forgets or loses creation information only when a user asks it to do so. Hence, it is entirely up to the user to make a computer retain or forget some information.

No IQ. A computer is not a magical device. It possesses no intelligence of its own. Its IQ is zero, at least until today. It has to be told what to do and in what sequence. Hence, only a user determines—at tasks a computer will perform. A computer cannot take its own decision in this regard.

No Feelings. Computers are devoid of emotions. They have no feelings and no instincts because they are Machines. Although men have succeeded in building a memory for computer, but no computer processes the equivalent of a human heart and soul. Based on our feelings, taste, knowledge, and experience we often make certain judgments in our day-to-day life whereas, computers cannot make judgments on their own. They make judgments based on the instructions given to them in the form of programs that are written by us (human beings).

1.2 Evolution of Computers

Necessity is the mother of invention. The saying holds true for computers too. Computers were invented because of man's search for fast and accurate calculating devices.

Blaise Pascal invented the first mechanical adding machine in 1642. Later, in the year 1671, Baron Gottfried Wilhelm von Leibniz of Germany invented the first calculator for multiplication. Keyboard machines originated States around 1880 and we use them even today. Around the same period, Herman Hollerith came up with concept of punched cards that were extensively used as input medium in computers even in late 1970s. Machines and calculators made their appearance in Europe and America towards the end of the century.

Charles Babbage, a nineteenth century Professor at Cambridge University, is considered the father of modern digital computers. He had employed a group of clerks for preparing mathematical and statistical tables. Babbage had to spend several hours checking these tables because even utmost care and precautions could not eliminate human errors. Soon he became dissatisfied and exasperated with this type of monotonous job. As a result, he started thinking about building a machine that could compute tables guaranteed to be error-free. In this process, Babbage designed a "Difference Engine" in the year 1822 that could produce reliable tables. In 1842, Babbage came out with his new idea of a completely automatic Analytical Engine for performing basic arithmetic functions for any mathematical problem at an average speed of 60 additions per minute. Unfortunately, he was unable to produce a working model of this machine because the precision engineering required to manufacture the machine was not available during that period. However, his efforts established a number of principles that are fundamental to the design of any digital computer. In order to have a better idea of the evolution of computers it is worthwhile to discuss of the well-known early computers. These are as follows:

1. **The Mark I Computer (1937-44).** Also known as Automatic Sequence Controlled calculator, this was the first fully automatic calculating machine designed by Howard A. Aiken of Harvard University in collaboration with IBM (International Business Machines) Corporation. It was an electro-mechanical device (used both electronic and mechanical components) based on the techniques already developed for punched card machines.

Although this machine proved to be extremely reliable, it was very complex in design and huge in size. It used over 3000 electrically actuated switches to control its operations and was approximately feet long and 8 feet high. It was capable of performing five basic arithmetic operations: addition, subtraction, multiplication, division, and table reference on numbers as big as 23 decimal digits. It took approximately 0.3 second to add two numbers and 4.5 seconds for multiplication of two numbers. Obviously, the machine was very slow as compared to today's computers.

2. **The Atanasoff-Berry Computer (1939-42).** Dr. John Atanasoff developed an electronic machine to solve certain mathematical equations. The machine was called the Atanasoff-Berry Computer, or ABC, after its inventor's name and his assistant, Clifford Berry. It used 45 vacuum tubes for internal logic and capacitors for storage.
3. **The ENIAC (1943-46).** The Electronic Numerical Integrator And Calculator (ENIAC) was the first all electronic computer. It was constructed at the Moore School of Engineering of the University of Pennsylvania, U.S.A. by a design team led by Professors J. Presper Eckert and John Mauchly.

The team developed ENIAC because of military needs. It was used for many years to solve ballistic related problems. It took up wall space in a 20 x 40 square feet room

and used 18,000 vacuum tubes it could add two numbers in 200 microseconds and multiply them in 2000 microseconds.

4. **The EDVAC (1946-52).** A major drawback of ENIAC was that its programs were wired on boards that made it difficult to change the programs. Dr. John Von Neumann later introduced the “stored program” concept that helped in overcoming this problem. The basic idea behind this concept is that a sequence of instructions and data can be stored in the memory of a computer for automatically directing the flow of operations. This feature considerably influenced the development of modern digital computers because of the ease with which different programs can be loaded and executed on the same computer. Due to this feature, we often refer to modern digital computers as stored program digital computers. The Electronic Discrete Variable Automatic Computer (EDVAC) used the stored’ program concept in its design. Von Neumann also has a share of the credit for introducing the idea of storing both instructions and data in binary form (a system that uses only two digits—0 and 1 to represent all characters), instead of decimal numbers or human readable words.
5. **The EDSAC (1947-49).** Almost simultaneously with EDVAC of U.S.A., the Britishers developed the Electronic Delay Storage Automatic Calculator (EDSAC). The machine executed its first program in May 1949. In this machine, addition operations took 1500 microseconds and multiplication operation: took 4000 microseconds. A group of scientists headed by Professor Maurice Wilkes at the Cambridge University Mathematical Laboratory developed this machine.
6. **The UNIVAC I (1951).** The Universal Automatic Computer (UNIVAC) was the first digital computer that was not “one of a kind”. Many UNIVAC machines were produced, the first of which was installed in the Census Bureau in 1951 and was used continuously for 10 years. The first business use of a computer, a UNIVAC I, was by General Electric Corporation in 1954. In 1952, the International Business Machines (IBM) Corporation introduced the IBM-701 commercial computer. In rapid succession, improved models of the UNIVAC I and other 700-series machines were introduced. In 1953, IBM produced the IBM-650, and sold over 1000 of these computers. UNIVAC marked the arrival of commercially available digital computers for business and scientific applications.



Did u know?

Some of the well-known early computers are the MARK 1 (1937-44), the ATANASOFF-BERRY (1939-42), the ENIAC (1943-46), the EDVAC (1946-52), the EDSAC (1947-49) and the UNIVAC I (1951).

1.3 Computer Generations

Generation in computer talk is a step in technology. It provides a framework for the growth of computer industry. Originally, the term “generation” was used to distinguish between varying hardware technologies but it has now been extended to include both hardware and software that together make up a computer system.

The custom of referring to computer era in terms of generations came into wide use only after 1964. There are totally five computer generations known till today. Below we describe each generation along with its identifying characteristics. Although there is a certain amount of overlap between different generations, the approximate period shown against each are normally accepted.

During description of various computer generations, you will come across several new terminologies and computer jargons that you may not be able to understand properly. However, the idea here is to provide you an overview of the major developments and technologies during the five generations of computers. Subsequent chapters will cover these

Notes

developments and technologies in detail. The objective of this section is mainly to provide an overview of what all you are going to learn in this entire book.

1.3.1 First Generation (1942-1955)

We have already discussed about some of the early computers—ENIAC, EDVAC, EDSAC, UNIVAC 1, and IBM 701. These machines and others of their time used thousands of vacuum tubes. A vacuum tube [see Figure 1.1](a) was a fragile glass device, which used filaments as a source of electronics and could control and amplify electronic signals. It was the only high-speed electronic switching device available in those days. These vacuum tubes computer could perform computations in milliseconds and were referred to as first-generation computers.

The memory of these computers used electromagnetic relays, and all data and instructions were fed into the system from punched cards. The instructions were written in machine and assembly languages because high-level programming languages were introduced much later. Since machine and assembly languages are very difficult to work with, only a few specialists understood how to program these early computers.

Characteristic features of first-generation computers are as follows:

1. They were the fastest calculating devices of their time.
2. They were too bulky in size, requiring large rooms for installation.
3. They used thousands of vacuum tubes that emitted large amount of heat and burnt out frequently. Hence, the rooms/areas in which these computers were located had to be properly air-conditioned.
4. Each vacuum tube consumed about half a watt of power. Since a computer typically used more than ten thousand vacuum tubes, power consumption of these computers was very high.
5. As vacuum tubes used filaments, they had a limited life. Because a computer used thousand of vacuum tubes, these computers were prone to frequent hardware failures.
6. Due to low mean time between failures, these computers required constant maintenance.
7. In these computers, thousands of individual components were assembled manually by hand in to electronic circuits. Hence, commercial production of these computers was difficult and costly.
8. Since these computers were difficult to program and use, they had limited commercial use.



Task

Give brief description about the first generation computer.

1.3.2 Second Generation (1955-1964)

John Bardeen, Willian Shockley, and Walter Brattain invented a new electronic switching device called transistor [see Figure 1.1(b)] at Bell Laboratories in 1947. Transistors soon proved to be a better electronic switching device than vacuum tubes due to their following properties:

1. They were more rugged and easier to handle than tubes since they were made of germanium semiconductor material rather than glass.

2. They were highly reliable as compared to tubes since they had no parts like a filament that could burn out.
3. They could switch much faster (almost ten times faster) than tubes. Hence, switching circuits made of transistors could operate much faster than their counterparts made of tubes.
4. They consumed almost one-tenth the power consumed by tube.
5. They were much smaller than a tube.
6. They were less expensive to produce.
7. They dissipated much less heat as compared to vacuum tubes.

The second-generation computers were manufactured using transistors instead of vacuum tubes. Due to the properties of transistors listed above, these computers were more powerful, more reliable, less expensive, smaller, and cooler to operate than the first-generation computers. They used magnetic cores for main memory, and magnetic disk and tape as secondary storage media. Punched cards were still popular and widely used for preparing and feeding programs and data to these computers.

On software front, high-level programming languages (like FORTRAN, COBOL, ALGOL, and SNOBOL) and batch operating system emerged during second-generation. High-level programming languages were easier for people to understand and work with than assembly or machine languages making second-generation computers easier to program and use than first-generation computers. Introduction of batch operating system enabled multiple jobs to be batched together and submitted at a time. A batch operating system causes automatic transition from one job to another as soon as the former job completes. This concept helped in reducing human intervention while processing multiple jobs resulting in faster processing, enhanced throughput, and easier operation of second-generation computers.

The first-generation computers were mainly used for scientific computations. However, the second-generation computers were increasingly used in business and industry for commercial data processing applications like payroll, inventory control, marketing, and production planning.

Characteristic features of second-generation computers are as follows:

1. They were more than ten times faster than the first-generation computers.
2. They were smaller than first-generation computers and required smaller space.
3. They consumed less power and dissipated less heat than the first-generation computers. The rooms/areas in which the second-generation computers were located still required to be properly air conditioned.
4. They were more reliable and less prone to hardware failures than the first generation computers.
5. They had faster and larger primary and secondary storage as compared to first-generation computers.
6. They were easier to program and use than the first-generation computers. Hence, they had wider commercial use.
7. In these computers, thousands of individual transistors had to be assembled manually by hand into electronic circuits making commercial production of these computers difficult and costly.

Notes

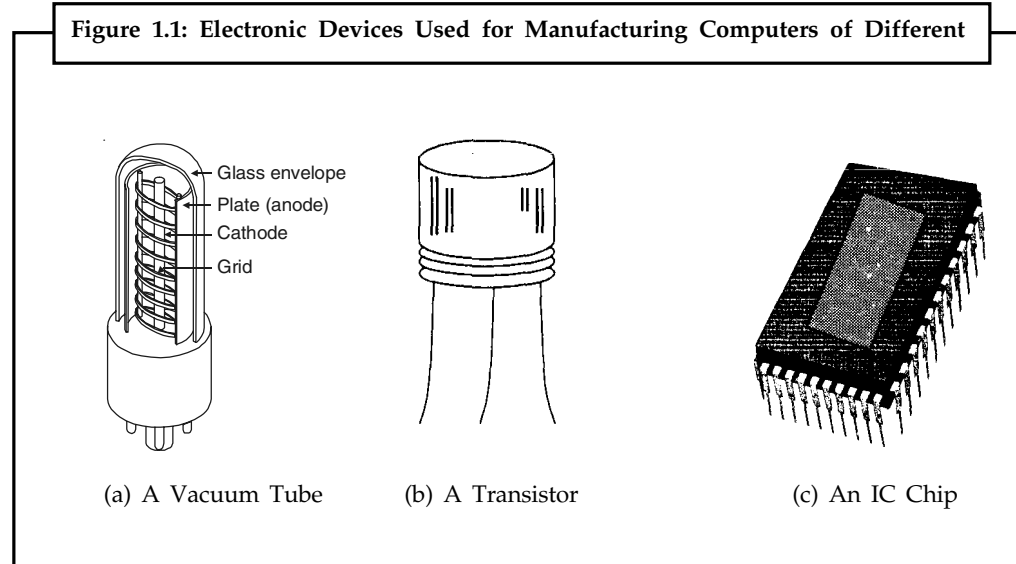

1.3.3 Third Generation (1964-1975)

In 1958, Jack Clair Kilby and Robert Noyce invented the first integrated circuit. *Integrated circuits* (called *ICs*) are circuits consisting of several electronic components like transistors, resistors, and capacitors grown on a single chip of silicon eliminating wired interconnection between components. The IC technology was also known, 0 technologies because it made it possible to integrate larger number of circuit components into very small (less than 5 mm square) surface of silicon, known as “chip” [see Figure 1.1(c)]. Initially the integrated circuits contained only about ten to twenty components. This technology was named *small scale integration* (SSI). Later with the advancement in technology for manufacturing ICs, it became possible to integrate up to about components on a single chip. This technology came to be known as *medium scale integration* (MSI).

Computers built using integrated circuits characterized the third generation. Earlier ones used SSI technology and later used MSI technology. ICs were smaller, less expensive to produce, more rugged and reliable, faster in operations, dissipated less heat, and consumed less power than circuits built by wiring electronic components manually. Hence third-generation computers were more powerful, more reliable, less expensive, smaller, and cooler to operate than second-generation computers.

Parallel advancements in storage technologies allowed construction of larger magnetic core based random access memory as well as larger capacity magnetic disks and tapes. Hence, third-generation computers typically had few megabytes (less than 5 Megabytes) of main memory and magnetic disks capable of storing few tens of megabytes of data per disk drive.

On software front, standardization of high-level programming languages, timesharing operating systems, unbundling of software from hardware, and creation of an independent software industry happened during third generation. FORTRAN and COBOL were the most popular high-level programming languages in those days. American National Standards Institute (ANSI) standardized them in 1966 and 1968 respectively, and the standardized versions were called ANSI FORTRAN and ANSI COBOL. The idea was that as long as programmers follows these standards in program writing, a program could be run on any computer with an ANSI FORTRAN or ANSI COBOL compiler. Some more high-level

programming languages were introduced during the third-generation period. Notable among these were PL/1, PASCAL, and BASIC.

Notes

We saw that second-generation computers used batch operating system. In these systems, users had to prepare their data and programs and then submit them to a computer centre for processing. The operator at the computer centre collected these user jobs and fed them to a computer in batches at scheduled intervals. The respective users then collected their job's output from the computer centre. The inevitable delay resulting from this batch processing approach was very frustrating to some users, especially programmers, because often they had to wait for days to locate and correct a few program errors. To rectify this situation, John Kemeny and Thomas Kurtz of Dartmouth College introduced the concept of timesharing operating system. Timesharing operating system enables multiple users to directly access and share computing resources simultaneously in a manner that each user feels that no one else is using the computer. This is accomplished by using a large number of independent relatively low-speed, on-line terminals connected to the main computer simultaneously. Introduction of timesharing concept helped in drastically improving the productivity of programmers and made on-line systems feasible, resulting in new on-line applications like airline reservation systems, interactive query systems, etc.

Until 1965, computer manufacturers sold their hardware along with all associated software without any separate charges for software. For example, buyers received language translators for all languages supported on a computer they purchased. From user's standpoint, software was free. However, the situation changed in 1969 when IBM and other computer manufacturers began to price their hardware and software products separately. This unbundling of software from hardware gave users an opportunity to invest only in software of their need and value. For example, now buyers could purchase only the language translators they needed and not all language translators supported on the purchased computer. This led to the creation of many new software houses and the beginning of an independent software industry.

Development and introduction of minicomputers also took place during the third-generation period. Computers built until the early 1960s were mainframe systems that only very large companies could afford to purchase and use. Clearly, a need existed for low-cost smaller computers to fill the gaps left by the bigger, faster, and costlier mainframe systems. Several innovators recognized this need and formed new firms in the 1960s to produce smaller computers. Digital Equipment Corporation (DEC) introduced the first commercially available minicomputer, the PDP-8 (Programmed Data Processor), in 1965. It could easily fit in the corner of a room and did not require attention of a full-time computer operator. It used timesharing operating system and a number of users could access it simultaneously from different locations in the same building. Its cost was about one-fourth the cost of a traditional mainframe system making it possible for smaller companies to afford computers. It confirmed the tremendous demand for small computers for business and scientific applications, and by 1971, there were more than 25 computer manufacturers in minicomputer market.

Characteristic features of third-generation computers are as follows:

1. They were more powerful than second-generation computers. They were capable of performing about one million instructions per second.
2. They were smaller than second-generation computers requiring smaller space.
3. They consumed less power and dissipated less heat than second-generation computers. The rooms/areas in which third-generation computers were located still required to be properly air-conditioned.

Notes

4. They were more reliable and less prone to hardware failures than second-generation computers requiring lower maintenance cost.
5. They had faster and larger primary and secondary storage as compared to second-generation computers.
6. They were general-purpose machines suitable for both scientific and commercial applications.
7. Their manufacturing did not require manual assembly of individual components into electronic circuits resulting in reduced human labor and cost involved at assembly stage. Hence, commercial production of these systems was easier and cheaper. However, highly sophisticated technology and expensive setup was required for the manufacture of IC chips.
8. Standardization of high-level programming languages allowed programs written for one computer to be easily ported to and executed on another computer.
9. Timesharing operating system allowed interactive usage and simultaneous use of these systems by multiple users.
10. Timesharing operating system helped in drastically improving the productivity of programmers down the time and cost of program development by several fold.
11. Timesharing operating system also made on-line systems feasible resulting in usage of these systems in-line applications.
12. Unbundling of software from hardware gave users of these systems an opportunity to invest only in software of their need and value.
13. Minicomputers of third-generation made computers affordable even by smaller companies.

1.3.4 Fourth Generation (1975-1989)

Average of electronic components packed on a silicon chip doubled each year after 1965. This progress soon led to the era of *large scale integration* (LSI) when it was possible to integrate over 30,000 electronic components on a single chip, followed by *very large scale integration* (VLSI) when it was possible to integrate about one million electronic components on a single chip. This progress led to a dramatic development — creation of a microprocessor. A *microprocessor* contains all circuits needed to perform arithmetic logic and control: functions, the core activities of all computers, on a single chip. Hence, it became possible to build a complete computer with a Microprocessor, a few additional primary storage chips, and other support circuitry. It started a new social revolution—*personal computer* (PC) revolution. Overnight computers became incredibly compact. They became inexpensive to make, and suddenly it became possible for anyone to own a computer.

During fourth generation, semiconductor memories replaced magnetic core memories resulting in large random access memories with very fast access time. On the other hand, hard disks became cheaper, smaller, and larger in capacity. In addition to magnetic tapes, floppy disks became very popular as a portable medium for porting programs and data from one computer system to another.

Another significant development during fourth-generation period was spread of high-speed computer networking enabling interconnection of multiple computers to enable them to communicate and share data. Local area networks (LANs) became popular for connecting

computers within an organization or within a campus. Similarly, wide area networks (WANs) became popular for connecting computers located at larger distances. This gave rise to networks computers and distributed systems.

Notes

On software front several new developments emerged to match the new technologies of fourth generation. For examples, several new operating systems were developed for PCs. Notable among these were MS-DOS, MS-windows, and apple's propriety OS. Since PCs were for individuals who were not computer professionals, companies developed graphical user interfaces for making computers more user friendly (easier to use). A *graphical user interface* ((*UI*) provides icons (pictures) and menus (list of choices) that users can select with a mouse. This enables new computer users to learn to use a PC quickly. Several new PC-based applications were also developed to make PCs a powerful tool. Notable among these were powerful word processing packages that allowed easy development of documents, spreadsheet package that allowed easy manipulation and analysis of data organized in columns and rows, and graphics packages that allowed easy drawing of pictures and diagrams. Another very useful concept that became popular during fourth-generation period was that of multiple windows on a single terminal screen. This feature allowed users to see the current state of several applications simultaneously in separate windows on same terminal screen. During fourth-generation period, UNIX operating system and C programming language also became very popular.

Characteristic features of fourth-generation computers are as follows:

1. PCs were smaller and cheaper than mainframes or minicomputers of third generation.
2. Although the fourth-generation mainframes required proper air-conditioning of the rooms/areas in which they were located, no air-conditioning was required for PCs.
3. They consumed less power than third-generation computers.
4. They were more reliable and less prone to hardware failures than third-generation computers requiring negligible maintenance cost.
5. They had faster and larger primary and secondary storage as compared to third-generation computers.
6. They were general-purpose machines.
7. Their manufacturing did not require manual assembly of individual components into electronic circuits resulting in reduced human labour and cost involved at assembly stage. Hence, commercial production of these systems was easier and cheaper. However, highly sophisticated technology and expensive setup was required for manufacturing LSI and VLSI chips.
8. Use of standard high-level programming languages allowed programs written for one computer to be easily ported to and executed on another computer.
9. Graphical user interface (GUI) enabled new users to quickly learn how to use computers.
10. PC-based applications made PCs a powerful tool for both office and home usage.
11. Network of computers enabled sharing of resources like disks, printers, etc. among multiple computers and their users. They also enabled several new types of applications involving interaction among computer users at geographically distant locations. *Computer Supported Cooperative Working* (CSCW), or *groupware* is one such application in which multiple members working on a single project and located at distant locations cooperate with each other by using a network of computers.

Notes

12. In addition to unbundled software, these systems also used add-on hardware feature that allowed users to invest only in the hardware configuration and software of their need and value.
13. PCs of fourth generation made computers affordable even by individuals for their personal use at home.

1.3.5 Fifth Generation (1989-Present)

The trend of further miniaturization of electronic components, dramatic increase in power of microprocessor-chips, and increase in capacity of main memory and hard disk continued during fifth generation. VLSI technology came *ULSI (Ultra Large Scale Integration)* technology in fifth generation resulting in production of Microprocessor chips having ten million electronic components. In fact, the speed of microprocessors and the size of main memory and hard disk doubled almost every eighteen months. As a result, many features found in the CPUs of large mainframe systems of third- and fourth-generation systems became part of microprocessor architecture in fifth generation. This ultimately resulted in availability of very powerful and compact computers becoming available at cheaper rates and death of traditional large mainframe systems. Due to this fast pace of advancement in computer technology, we see more compact and more powerful computers being introduced almost every year at more or less the same price or even cheaper. Notable among these are portable notebook computers that give the power of a PC to their users even while travelling, powerful desktop PCs and workstations, powerful servers, and very powerful supercomputers.

Storage technology also advanced very fast making larger and larger main memory and disk storage available in newly introduced systems. During fifth generation, optical disks also emerged as a popular portable mass storage *D-ROM (Compact Disk - Read Only Memory)*.

During fifth generation, there was tremendous outgrowth of computer networks. Communication technologies become faster day-by-day and more and more computers were networked together. This trend resulted in emergence and popularity of the Internet and associated technologies and applications. The Internet made it possible for computer users sitting across the globe to communicate with each other within minutes by use of electronic mail (known as *e-mail*) facility. A vast ocean of information became readily available to computer users through the World Wide Web (known as WWW). Moreover, several new types of exciting applications like e-commerce, virtual libraries, virtual classrooms, distance education, etc., emerged during the period.

Tremendous processing power and massive storage capacity of fifth-generation computers also made them a very popular tool for a wide range of multimedia applications that deal with information containing text, graphics animation, audio, and video data. In general, the data size of multimedia information is much larger than textual information because representation of graphics, animation, audio, or video media in digital form requires larger number of bits than that required for representation of textual information.

Characteristic features of fifth-generation computers are as follows:

1. Portable PCs (called notebook computers) are much smaller and handy than PCs of fourth generation allowing users to use computing facility even while travelling.
2. Fifth-generation desktop PCs and workstations are several times more powerful than PCs of fourth generation.

3. Although fifth-generation mainframes require proper air-conditioning of the rooms/ areas in which they are located, no air-conditioning is normally required for notebook computers, desktop PCs, and workstations.
4. They consume less power than their predecessors do.
5. They are more reliable and less prone to hardware failures than their predecessors were, requiring negligible maintenance cost.
6. Many of the large-scale fifth-generation systems have hot-plug feature that enables a failed component to be replaced with a new one without the need to shutdown the system. Hence, the uptime of these systems is very high.
7. They have faster and larger primary and secondary storage as compared to their predecessors.
8. They are general-purpose machines.
9. Their manufacturing does not require manual assembly of individual components into electronic circuits resulting in reduced human labour and cost involved at assembly stage. Hence, commercial production of these systems is easier and cheaper. However, highly sophisticated technology and expensive setup (affordable only by a few organizations in the world) is required for manufacturing IJLSI chips.
10. Use of standard high-level programming languages allows programs written for one computer to be easily ported to and executed on another computer.
11. More user-friendly interfaces with multimedia features make the systems easier to learn and use by anyone, including children.
12. Newer and more powerful applications, including multimedia applications, make the systems more useful in every occupation.
13. Explosion in the size of the Internet coupled with Internet-based tools and applications have made these systems influence the life of even common people.
14. These systems also use the concept of unbundled software and add-on hardware allowing the users to invest only in the hardware configuration and software of their need and value.
15. With so many types of computers in all price ranges today, we have a computer for almost any type of user whether the user is a child or a world-fame scientist.

We have looked at the history of computing divided into five generations and we have seen how quickly things have changed in the last few decades. Technological progress in this area is continuing at the same rate even now. In fact, the fastest-growth period in the history of computing may be still ahead.



Did u know?

An integrated circuit (IC) is a small electronic device made out of a semiconductor material. The first integrated circuit was developed in the 1950s by Jack Kilby of Texas Instruments and Robert Noyce of Fairchild Semiconductor.



Task

Describe the main different of first generation computer and third generation computer.

1.4 Block Diagram of Computer

The basic components of a computer are:

- Input Unit
- Output Unit
- Memory/Storage Unit
- Arithmetic Logic Unit
- Control Unit
- Central Processing Unit

These are shown in Figure 1.2.

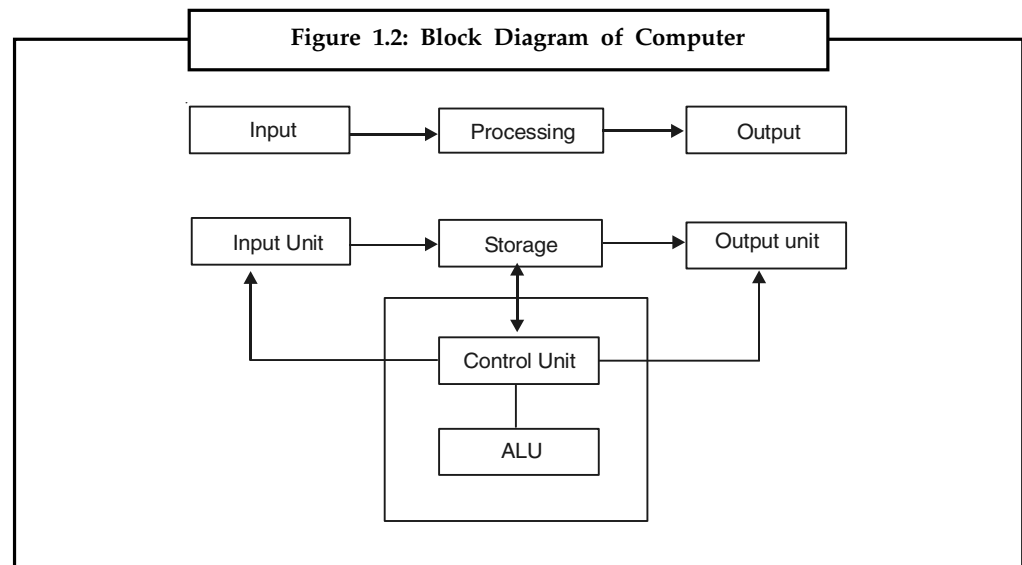

A computer can process data, pictures, sound and graphics. They can solve highly complicated problems quickly and accurately.

1.4.1 Input Unit

Computers need to receive data and instruction in order to solve any problem. Therefore, we need to input the data and instructions into the computers. The input unit consists of one or more input devices. Keyboard is the one of the most commonly used input devices. Other commonly used input devices are the mouse, floppy disk drive, magnetic tape, etc. All the input devices perform the following functions:

- Accept the data and instructions from the outside world.
- Convert it to a form that the computer can understand.
- Supply the converted data to the computer system for further processing.

1.4.2 Storage Unit

The storage unit of the computer holds data and instructions that are entered through the input unit, before they are processed. It preserves the intermediate and final results before these are sent to the output devices. It also saves the data for the later use. The various storage devices of a computer system are divided into two categories:

- 1. Primary Storage:** Stores and provides very fast. This memory is generally used to hold the program being currently executed in the computer, the data being received from the input unit, the intermediate and final results of the program. The primary memory is temporary in nature. The data is lost, when the computer is switched off. In order to store the data permanently, the data has to be transferred to the secondary memory. The cost of the primary storage is more compared to the secondary storage. Therefore, most computers have limited primary storage capacity.
- 2. Secondary Storage:** Secondary storage is used like an archive. It stores several programs, documents, data bases etc. The programs that you run on the computer are first transferred to the primary memory before it is actually run. Whenever the results are saved, again they get stored in the secondary memory. The secondary memory is slower and cheaper than the primary memory. Some of the commonly used secondary memory devices are Hard disk, CD, etc.

1.4.3 Memory Size

All digital computers use the binary system, i.e. 0's and 1's. Each character or a number is represented by an 8 bit code. The set of 8 bits is called a byte. A character occupies 1 byte space. A numeric occupies 2 byte space. Byte is the space occupied in the memory. The size of the primary storage is specified in KB (Kilobytes) or MB (Megabyte). One KB is equal to 1024 bytes and one MB is equal to 1000 KB. The size of the primary storage in a typical PC usually starts at 16 MB. PCs having 32 MB, 48 MB, 128 MB, 256 MB memory are quite common.

1.4.4 Output Unit

The output unit of a computer provides the information and results of a computation to outside world. Printers, Visual Display Unit (VDU) are the commonly used output devices. Other commonly used output devices are floppy disk drive, hard disk drive and magnetic tape drive.

1.4.5 Arithmetic Logical Unit

All calculations are performed in the Arithmetic Logic Unit (ALU) of the computer. It also does comparison and takes decision. The ALU can perform basic operations such as addition, subtraction, multiplication, division, etc and does logic operations viz, >, <, =, 'etc. Whenever calculations are required, the control unit transfers the data from storage unit to ALU once the computations are done, the results are transferred to the storage unit by the control unit and then it is send to the output unit for displaying results.

1.4.6 Control Unit

It controls all other units in the computer. The control unit instructs the input unit, where to store the data after receiving it from the user. It controls the flow of data and instructions from the storage unit to ALU. It also controls the flow of results from the ALU to the storage unit. The control unit is generally referred as the central nervous system of the computer that control and synchronizes its working.

1.4.7 Central Processing Unit

The control unit and ALU of the computer are together known as the Central Processing Unit (CPU). The CPU is like brain performs the following functions:

- It performs all calculations.
- It takes all decisions.
- It controls all units of the computer.

Notes

A PC may have CPU-IC such as Intel 8088, 80286, 80386, 80486, Celeron, Pentium, Pentium Pro, Pentium II, Pentium III, Pentium IV, Dual Core, and AMD etc.



Did u know?

The activity of processing data using a computer is called data processing. Data is raw material used as input to data processing and information is processed data obtained as output of data processing.



Case Study

Success Story of First Generation Computers

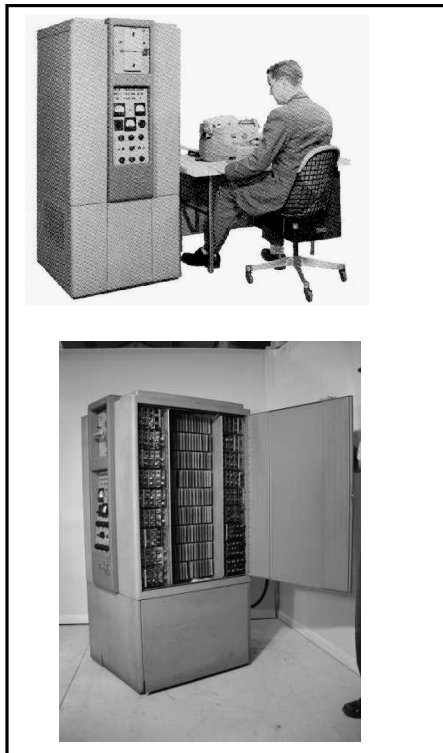

It is the Bendix G-15 General Purpose Digital Computer, a First Generation computer introduced in 1956.

Bendix introduced their G-15 in 1956. It was not the first Bendix computing machine. They introduced a model named the D-12, in 1954. However, the D-12 was a digital differential analyser and not a general purpose computer.

The G-15 was superceded by the second generation (transistorised) Bendix G-20.

The Bendix G-15 was a fairly sophisticated, medium size computer for its day. It used a magnetic drum for internal memory storage and had 180 tube packages and 300 germanium diode packages for logical circuitry. Cooling was by internal forced air.

Storage on the Magnetic Drum comprised 2160 words in twenty channels of 108 words each. Average access time was 4.5 milliseconds. In addition, there were 16 words of fast-access storage in four channels of 4 words each, with average access time of 0.54 milliseconds; and eight words in registers consisting of 1 one-word command register, 1 one-word arithmetic register, and 3 two-word arithmetic registers for double-precision operations.

Contd...

A 108-word buffer channel on the magnetic drum allowed input-output to proceed simultaneously with computation.

Word size was 29 bits, allowing single-precision numbers of seven decimal digits plus sign during input-output and twenty nine binary digits internally, and double-precision numbers of fourteen decimal digits plus sign during input-output, fifty eight binary digits internally.

Each machine language instruction specified the address of the operand and the address of the next instruction. Double-length arithmetic registers permitted the programming of double-precision operations with the same ease as single-precision ones.

An interpreter called Intercom 1000 and a compiler called Algo provided simpler alternatives to machine language programming. Algo followed the principles set forth in the international algorithmic language, Algol, and permitted the programmer to state a problem in algebraic form. The Bendix Corporation claimed to be the first manufacturer to introduce a programming system patterned on Algol.

The basic computation times, in milliseconds, were as follows (including the time required for the computer to read the command prior to its execution). The time range for multiplication and division represents the range between single decimal digit precision and maximum precision.

External Storage was provided on searchable paper tape (2,500 words per magazine) and, optionally, on one to four, magnetic tape units with 300,000 words per tape unit reel.



Questions:

1. What is the purpose of developing the first generation computer?
2. What is its basic computation times?

1.5 Summary

- The word computer comes from the word “compute”, which means, “to calculate”.
- Then characteristics of computer discuss which include Automatic Machine, Speed, Accuracy, Diligence, Versatility, Power of Remembering.
- Computer generation like First Generation (1942-1955), Second Generation (1955-1964), Third Generation (1964-1975), Fourth Generation (1975-1989) and Fifth Generation (1989-Present).
- Block Diagram of Computer means sub part of computer like input, output and memory devices.
- The control processing unit is combination of ALO and Au.

1.6 Keywords

Data processing: The activity of processing data using a computer is called data processing.

Generation: Originally, the term “generation” was used to distinguish between varying hardware technologies but it has now been extended to include both hardware and software that together make up a computer system.

Integrated circuits: They are usually called ICs or chips. They are complex circuits which have been etched onto tiny chips of semiconductor (silicon). The chip is packaged in a plastic holder with pins spaced on a 0.1" (2.54 mm) grid which will fit the holes on stripboard and breadboards. Very fine wires inside the package link the chip to the pins.

Medium scale integration (MSI): Medium-Scale Integration is a term used in electronic chip manufacturing industry. An integrated circuit which contained hundreds of transistors on each chip, called Medium-Scale Integration (MSI).

Small-scale integration” (SSI): The first integrated circuits contained only a few transistors. Called “Small-Scale Integration” (SSI), they used circuits containing transistors numbering in the tens.

Storage unit: The storage unit of the computer holds data and instructions that are entered through the input unit, before they are processed. It preserves the intermediate and final results before these are sent to the output devices.

Very-large-scale integration (VLSI): It is the process of creating integrated circuits by combining thousands of transistors into a single chip.



Lab Exercise

1. Explain all computer generation.

1.7 Self-Assessment Questions

1. Computer’s third generation is from..... to
 - (a) 1955-1964
 - (b) 1964-1975
 - (c) 1942-1955
 - (d) 1975-1989
2. Developed an electronic machine to solve certain mathematical equations.
 - (a) Dr John Atanasoff
 - (b) Herman Hollerith
 - (c) Professors J. Presper Eckert
 - (d) All of these
3. The activity of processing data using a computer is called Data handling.
 - (a) True
 - (b) False
4. ULSI stands for.....
 - (a) Ultra Located Scale Integration
 - (b) Ultra Large Scale Itegartion
5. Portable PCs also called
 - (a) Book computer
 - (b) Notebook computers

6. The second generation computers were manufactured by using Notes
- (a) Vacuum tubes (b) Transistors
(c) IC Chip (d) None of above
7. ANSI stands for.....
- (a) American National Standards Institute
(b) Asia National Standards Institute

1.8 Review Questions

1. What is a computer? Why is it also known as a data processor?
2. What is data processing? Differentiate between data and information. Which is more useful to the people and why?
3. List and explain some important characteristics of a computer.
4. What is garbage-in-garbage-out?
5. Who is known as the father of modern digital computers and why?
6. Who invented the concept of stored program? Why is this concept so important?
7. Why are modern digital computers often referred to as stored program digital computers?
8. Which was the first commercially produced computer? When and where was it first installed?
9. Write full form of following abbreviations used in computer terminology: IBM, ENIAC, EDVAC, EDSAC, UNIVAC.
10. What is "generation" in computer terminology? How many computer generations are there till date?
11. List the various computer generations along with the key characteristics of computers of each generation.
12. List key hardware technologies used in building computers of each of the five generations.
13. List key software technologies used in building computers of each of the five generations.
14. What is an IC? How does it help in reducing the size computers?
15. Why were first- and second-generation computers more difficult and costlier to produce commercially than computer of subsequent generations?
16. Name the technologies used for constructing main memory in first-, second-, third-, and fourth-generation computers.
17. Name the secondary storage media popularly used, i.e. first-, second-, third-, fourth-, and fifth-generation computers.
18. What is a microprocessor? How did it revolutionize the computer industry?
19. Name some applications that emerged due to emergence of computer networks.
20. Name some applications that emerged due to emergence of the Internet.
21. Name some representative computer systems of each of the five computer generations.

Notes

Answers to Self-Assessment Questions

- | | | | |
|--------|--------|--------|--------|
| 1. (b) | 2. (a) | 3. (b) | 4. (b) |
| 5. (b) | 6. (b) | 7. (a) | |

1.9 Further Readings



Books

Fundamental Computer Concepts, William S. Davis.

Fundamental Computer Skills, Feng-Qi Lai, David R. Hofmeister.



Online link

<http://books.google.co.in/bkshp?hl=en>

Unit 2: Introduction to Data Representations

CONTENTS

Objectives

Introduction

2.1 Data Representations

2.1.1 Binary Number System

2.1.2 Octal Number System

2.1.3 Hexadecimal Number System

2.2 Converting from One Number System to Another

2.2.1 Converting from Another Base to Decimal

2.2.2 Converting from Decimal to Another Base (Division-Remainder Technique)

2.2.3 Converting from a Base Other Than 10 to Another Base Other Than 10

2.2.4 Shortcut Method for Octal to Binary Conversion

2.2.5 Shortcut Method for Binary to Hexadecimal Conversion

2.2.6 Shortcut Method for Hexadecimal to Binary Conversion

2.3 Summary

2.4 Keywords

2.5 Self-Assessment Questions

2.6 Review Questions

2.7 Further Readings

Objectives

After studying this unit, you will be able to:

- Understand the concept of Data representation in binary number, Octal number and Hexadecimal number system
- Discussed how to convert any number system to another
- Explain the short cut method for octal to binary conversion, Binary to Hexadecimal Conversion and Hexadecimal to Binary Conversion.

Introduction

While the basic memory unit in a digital computer is the bit, holding a value of 1 or 0, or equivalently ON or OFF, most information of interest to the user requires more than a simple bi-valued representation. Thus, it is practical to form groups of bits, each consisting of some carefully chosen number of bits, and design the computer hardware to deal with these groups as complete units. In modern computers the most basic group consists of 8

Notes

bits, called the byte. Most computers implement groupings of two bytes, 4 bytes, and 8 bytes.

2.1 Data Representations

In order to discuss how data is processed by a computer, we should first understand the form in which data is stored in its memory.

There are two basic types of data which are stored and processed by computers, namely character and numbers. Characters include letters and special symbols. For example, computer may be programmed to read a list of names, sort them in alphabetical order and print the sorted list. A list of names, such as VINEET, PRADIP, GANESH read by an input unit would be stored in memory, sorted by the program in alphabetical order and printed the strings being VINEET, PRADIP and GANESH.

The other type of data is decimal numbers such as 1234, 456 etc. Numbers are processed using arithmetic operations such add, subtract, multiply and divide. In this case, we assign values to numbers and the processing results in new values.

The characters and numbers fed to a computer, and the output from the computer, must be in a form which is usable by people. For this purpose natural language symbols and decimal digit are appropriate. These constitute the external data representation. On the other hand, the representation of data inside a computer must match the technology used by the computer to store and process data. Thus we should first determine the most appropriate internal representation to internal representation and vice versa.

2.1.1 Binary Number System

Binary number system is like decimal number system, except that the base is 2, instead of 10. We can use only two symbols or digit (0 and 1) in this number system. Note that the largest single digit is 1(one less than the base) each position in a binary number represents a power of the base (2). Hence, in this system, the rightmost position, is units (2^0) position, the position from the right is 2's (2^1) position, and proceeding in this way, we have 4's (2^2) position, 8's (2^3) position, 16's (2^4) position, and so on. Therefore, decimal equivalent of binary number 10101(written as 10101_2) is:

$$(1 \times 2^4) + (0 \times 2^3) + (1 \times 2^2) + (0 \times 2^1) + (1 \times 2^0) = 16 + 0 + 4 + 0 + 1 = 21$$

In order to be specific about which system we are referring to, it is a common practice to indicate the base as a subscript. Hence, we write,;

$$10101_2=21_{10}$$

The short form of "binary digit" is *bit*. Hence, a "bit" in computer terminology means either a 0 or 1.

An n-bit number is a binary number consisting of 'n' bits. Figure 1.3 lists all 3-bit numbers along with their decimal equivalent. Remember that we have only two digits, 0 and 1, in binary number system and hence, binary equivalent of decimal number 2 has to be stated as 10 (read as one, zero). Another important point to note is that with 3 bits (positions), only $8(2^3)$ different patterns of 0s and 1s are possible, and it may be seen from Figure 1.3 that a 3-bit number can have one of the 8 values in the range 0 to 7. In fact, any decimal number in the range 0 to 2^{n-1} can be represented in binary form as an n-bit number.

Figure 2.1: Bit Numbers with Their Decimal Values

000	0
001	1
010	2
011	3
100	4
101	5
110	6
111	7

Every computer stores numbers, letters, and other special characters in binary form. There are several occasions when computer professionals need to know the raw data contained in a computer's memory. A commonly used way of doing this is to print memory contents on a printer. This printout is called a *memory dump*. Memory dumps, which are in binary numbers, would have many pages of 0s and 1s. Working with these numbers would be very difficult and error prone for computer professionals. Hence, two number systems—octal and hexadecimal, are often used as shortcut notations for binary. These number systems and their relationship with binary number system are explained below.

2.1.2 Octal Number System

In octal number system, the base is 8. Hence, there are only eight symbols or digits: 0, 1, 2, 3, 4, 5, 6, and 7 (8 and 9 do not exist in this system). The largest single digit is 7 (one less than the base 8). Each position in an octal number represents a power of the base (8). Therefore, decimal equivalent of octal number 2057 (written as 2057_8), is:

$$(2 \times 8^3) + (0 \times 8^2) + (5 \times 8^1) + (7 \times 8^0) = 1024 + 0 + 40 + 7 = 1071 \text{ Hence, } 2057_8 = 1071_{10}$$

Observe that since there are only 8 digits in octal number system, 3 bits ($2^3 = 8$) are sufficient to represent any octal number in binary (see Figure 1.3).

2.1.3 Hexadecimal Number System

In hexadecimal number system, the base is 16. Hence, there are 16 symbols or digits. The first 10 digits are the same digits of decimal number system - 0, 1, 2, 3, 4, 5, 6, 7, 8, and 9. The remaining six digits are denoted by the symbols A, B, C, D, E, and F, representing decimal values 10, 11, 12, 13, 14, and 15, respectively. Hence, the largest single digit is F or 15 (one less than the base 16). Each position in hexadecimal number system represents a power of the base (16). Therefore, decimal equivalent of hexadecimal number 1AF (written as $1AF_{16}$) is: $23 (1 \times 16^2) + (A \times 16^1) + (F \times 16^0) = (1 \times 256) + (10 \times 16) + (15 \times 1) = 256 + 160 + 15 = 431$ Hence, $1AF_{16} = 431_{10}$

Observe that since there are only 16 digits in hexadecimal number system, 4 bits ($2^4 = 16$) are sufficient to represent any hexadecimal number in binary.



Did u know?

In our day-to-day life, we use the decimal number system. In this system, base is equal to 10 because there are altogether ten symbols or digits (0, 1, 2, 3, 4, 5, 6, 7, 8, and 9).

2.2 Converting from One Number System to Another

Numbers expressed in decimal number system are much more meaningful to us, than are numbers expressed in any other number system. This is because we have been using decimal numbers in our day-to-day life, right from childhood; however, we can represent any number in one number system in any other number system. Because the input and final output values are to be in decimal, computer professionals are often required to convert number in other systems to decimal and vice-versa. Many methods can be used to convert numbers from one base to another. A method of converting from another base to decimal, and a method of converting from decimal to another base are described below.

2.2.1 Converting from Another Base to Decimal

The following steps are used to convert a number in any other base to a base 10 (decimal) number:

- Step 1:** Determine the column (positional) value of each digit (this depends on the position of the digit and the base of the number system).
- Step 2:** Multiply the obtained column values (in Step 1) by the digits in the corresponding columns.
- Step 3:** Sum up the products calculated in Step 2. The total is the equivalent value in decimal.

 Example: 1: $11001_2 = ?_{10}$

Step 1: Determine column Values

Column Number (From Right)	Column
1	$2^0 = 1$
2	$2^1 = 2$
3	$2^2 = 4$
4	$2^3 = 8$
5	$2^4 = 16$

Step 2: Multiply the column values by the corresponding column digits.

16	8	4	2	1
x1	x1	x0	x0	x1
16	8	0	0	1

Step 3: Sum up the products

$$16 + 8 + 0 + 0 + 1 = 25$$

$$\text{Hence, } 11001_2 = 25_{10}$$

 Example: 2: $4706_8 = ?_{10}$

Step 1: Determine column values

Column Number (From Right)	Column
1	$8^0 = 1$
2	$8^1 = 8$
3	$8^2 = 64$
4	$8^3 = 512$

Step 2: Multiply the column values by the corresponding column digits

Notes

$$\begin{array}{r}
 512 \quad 64 \quad 8 \quad 1 \\
 \times 4 \quad \times 7 \quad \times 0 \quad \times 6 \\
 \hline
 2048 \quad 448 \quad 0 \quad 6 \\
 \hline
 \end{array}$$

Step 3: Sum up the products

$$2048 + 448 + 0 + 6 = 2502$$

$$\text{Hence, } 4706_8 = 2502_{10}$$



Example: 3: $1AC_{16} = ?_{10}$

$$\begin{aligned}
 1AC_{16} &= 1 \times 16^2 + A \times 16^1 + C \times 16^0 \\
 &= 1 \times 256 + 10 \times 16 + 12 \times 1 \\
 &= 256 + 160 + 12 \\
 &= 428_{10}
 \end{aligned}$$



Example: 4: $4052_7 = ?_{10}$

$$\begin{aligned}
 4052_7 &= 4 \times 7^3 + 0 \times 7^2 + 5 \times 7^1 + 2 \times 7^0 \\
 &= 4 \times 343 + 0 \times 49 + 5 \times 7 + 2 \times 1 \\
 &= 1372 + 0 + 35 + 2 = 1409_{10}
 \end{aligned}$$



Example: 5: $4052_6 = ?_{10}$

$$\begin{aligned}
 4052_6 &= 4 \times 6^3 + 0 \times 6^2 + 5 \times 6^1 + 2 \times 6^0 \\
 &= 4 \times 216 + 0 \times 36 + 5 \times 6 + 2 \times 1 \\
 &= 864 + 0 + 30 + 2 \\
 &= 896_{10}
 \end{aligned}$$



Notes

Comparing this results with the result obtained in Example 4, we find that although the digits (4052) are the same for both the numbers, their decimal equivalents are different. This is because the number system, whereas the number in Example 5 is represented in base 6 number system.



Example: 6: 11001_4

$$\begin{aligned}
 11001_4 &= 1 \times 4^4 + 1 \times 4^3 + 0 \times 4^2 + 0 \times 4^1 + 1 \times 4^0 \\
 &= 1 \times 256 + 1 \times 64 + 0 \times 16 + 0 \times 4 + 1 \times 1 \\
 &= 256 + 64 + 0 + 0 + 1 \\
 &= 321_{10}
 \end{aligned}$$

Compare the result with the result obtained in Example 1.

Notes



Example: $7: 1AC_{13}=?_{10}$

$$\begin{aligned} 1AC_{13} &= 1 \times 13^2 + A \times 13^1 + C \times 13^0 \\ &= 1 \times 169 + 10 \times 13 + 12 \times 1 \\ &= 311_{10} \end{aligned}$$

Compare the result with the result obtained in Example 3

2.2.2 Converting from Decimal to Another Base (Division-Remainder Technique)

The following steps are used to convert a base 10 (decimal) number to a number in another base

- Step 1:** Divide the decimal number by the value of the new base.
- Step 2:** Record the remainder from Step 1 as the rightmost digit (least significant digit) of the new base number.
- Step 3:** Divide the quotient of the previous division by the new base.
- Step 4:** Record the remainder from Step 3 as the next digit (to the left) of the new base number. Repeat Steps 3 and 4, recording remainders from right to left, until the quotient becomes zero in Step 3. Note that the last remainder, thus obtained, will be the most significant digit of the new base number.



Example: **Steps 1 and 2:** $25/2 = 12$ and remainder 1

Steps 3 and 4: $12/2 = 6$ and remainder 0

Steps 3 and 4: $6/2 = 3$ and remainder 0

Steps 3 and 4: $3/2 = 1$ and remainder 1

Steps 3 and 4: $1/2 = 0$ and remainder 1.

As mentioned in Steps 2 and 4, the remainders are now arranged in the reverse order, making the first remainder the least significant digit (LSD) and the last remainder the most significant digit (MSD).

Hence, $25_{10} = 11001_2$

Compare the result with the result obtained in above Example 1.

2.2.3 Converting from a Base Other Than 10 to Another Base Other Than 10

The following steps are used to convert a number in a base other than 10, to number base other than 10:

- Step 1:** Convert the original number to a base (decimal) number.
- Step 2:** Convert the decimal number obtained in step 1 to the new base number.



Example: $545_6 = ?_4$

Step 1: Convert from base 6 to base 10

$$\begin{aligned} 545_6 &= 5 \times 6^2 + 4 \times 6^1 + 5 \times 6^0 \\ &= 5 \times 36 + 4 \times 6 + 5 \times 1 \\ &= 180 + 24 + 5 \\ &= 209_{10} \end{aligned}$$



Example: **Step 2:** Convert 209_{10} to base 4

Notes

4	209	Remainder
	52	1
	13	0
	3	1
	0	3

$$209_{10} = 3101_4$$

$$\text{Therefore, } 545_6 = 209_{10} = 3101_4$$

$$\text{Hence, } 546_6 = 3101_4$$

Above example illustrates the method of converting a binary number to an octal number.

Shortcut method for binary to octal Conversion. The following steps are used in this method:

Step 1: Divide the binary digits into groups of three (starting from the right).

Step 2: Convert each group of three binary digit to one octal digit. Since there are only 8 digits (0 to 7) in octal number system, 3 bits ($2^3 = 8$) are sufficient to represent any octal number in binary to decimal conversion method in this step.



Example: $101110_2 = ?_8$

Step 1: Divide the binary digits into groups of 3, starting the right (LSD).

101 110

Step 2: Convert each group into one digit of octal (use binary- to- decimal conversion method).

$$\begin{array}{ll}
 101_2 = 1 \times 2^2 + 0 \times 2^1 + 1 \times 2^0 & 110_2 = 1 \times 2^2 + 1 \times 2^1 + 0 \times 2^0 \\
 = 4 + 0 + 1 & 4 + 2 + 0 \\
 = 5_8 & 6_8
 \end{array}$$

$$\text{Hence, } 101110_2 = 56_8$$

2.2.4 Shortcut Method for Octal to Binary Conversion

The following steps are used in this method:

Step 1: Convert each octal digit to a 3 digit binary number (the octal digits may be treated as decimal numbers for this conversion).

Step 2: Combine all the resulting binary groups (of 3 digits each) into a single binary number.



Example: $562_8 = ?_2$

Step 1: Convert each octal digit to 3 Binary digits.

$$5_8 = 101_2$$

$$6_8 = 110_2$$

$$2_8 = 010_2$$

Notes

Step 2: Combine the binary groups.

$$562_8 = \frac{101}{5} \quad \frac{110}{6} \quad \frac{010}{2}$$

Hence, $562_8 = 101110010_2$

2.2.5 Shortcut Method for Binary to Hexadecimal Conversion

The following steps are used in this method:

Step 1: Divide the binary digits into groups of four (starting from the right).

Step 2: Convert each group of four binary digits to one hexadecimal digit. Remember that hexadecimal digits 0 to 9 are equal to decimal digits 0 to 9 and hexadecimal digits A to F are equal to decimal values 10 to 15. Hence, for this step, we use binary to decimal conversion procedure and represent decimal values 10 to 15 as hexadecimal A to F.



For binary to hexadecimal conversion we have to remember that hexadecimal digits 0 to 9 are equal to decimal digits 0 to 9 and hexadecimal digits A to F are equal to decimal values 10 to 15. Hence, for this step, we use binary to decimal conversion procedure and represent decimal values 10 to 15 as hexadecimal A to F.



Example: $11010011_2 = ?_{16}$

Step 1: Divide the binary digit into groups of 4, starting from the right (LSD)

$$1101 \quad 0011$$

Step 2: Convert each group of 4 binary digit to 1 hexadecimal digit

$$\begin{aligned} 1101_2 &= 1 \times 2^3 + 1 \times 2^2 + 0 \times 2^1 + 1 \times 2^0 &= 0 \times 2^3 + 0 \times 2^2 + 1 \times 2^1 + 1 \times 2^0 \\ &= 8 + 4 + 0 + 1 &= 0 + 0 + 2 + 1 \\ &= 13_{10} &= 3_{16} \\ &= D_{16} \end{aligned}$$

Hence, $11010011_2 = D3_{16}$

2.2.6 Shortcut Method for Hexadecimal to Binary Conversion

The following steps are used in this method:

Step 1: Convert decimal equivalent of each hexadecimal digit to 4 binary digits.

Step 2: Combine all resulting binary groups (4 digits each) into a single binary number.



Example: $2AB_{16} = ?_2$

Step 1: Convert decimal equivalent each hexadecimal digit to 4 binary digits.

$$2_{16} = 2_{10} = 0010_2$$

$$A_{16} = 10_{10} = 1010_2$$

$$B_{16} = 11_{10} = 1011_2$$

Step 2: Combine the binary groups.

Notes

$$2AB_{16} = \frac{0010}{2} \frac{0010}{A} \frac{1011}{B}$$

$$\text{Hence, } 2AB_{16} = 001010101011_2$$

Figure 1.4 summarizes the relationship among decimal, hexadecimal, binary, and octal number systems. Note that the maximum value for a single digit of octal (7) is equal to the maximum value of three digits of binary. The value range of one digit of octal duplicates the value range of three digits of binary. If we substitute octal digits for binary digits, the substitution is on a one-to-three basis. Hence, computers that print octal numbers instead binary, while taking memory dump, save one-third of printing space and time.

Similarly, note that the maximum value of one digit in hexadecimal is equal to the maximum value of four digits in binary. Hence, the value range of one digit of hexadecimal is equivalent to the value range of four digits of binary. Therefore, hexadecimal shortcut notation is a one-to-four reduction in space and time required for memory dump.

Figure 2.2: Relationship Among Decimal, Hexadecimal, Binary and Octal Number Systems

<i>Decimal</i>	<i>Hexadecimal</i>	<i>Binary</i>	<i>Octal</i>
0	0	0	0
1	1	1	1
2	2	10	2
3	3	11	3
4	4	100	4
5	5	111	5
6	6	110	6
7	7	111	7
8	8	1000	10
9	9	1001	11
10	A	1010	12
11	B	1011	13
12	C	1100	14
13	D	1101	15
14	E	1110	16
15	F	1111	17
16	10	10000	20

Notes



Case Study

Graphical Representation of Data

Once we have data organized in tabular form we can represent it as a graph. We are going to build a basic histogram (also called, for the time being, a bar graph or frequency distribution graph) using Excel Chart Wizard. Again, there are numerous approaches to building and modifying graphs; the method shown below is just one, and not necessarily the most correct, easiest, or clearest for everyone.

Mechanics of constructing a basic histogram

1. Highlight values in the frequency (/) column (don't include the total), E3:E9, and click on the chart wizard icon. (Now might be a good time to turn on the ScreenTips associated with the cursor. The command is in Tools-Customize-Option. ScreenTips are sometimes handy when constructing graphs. The tips show themselves about 1.5 seconds after you point to items such as an icon.

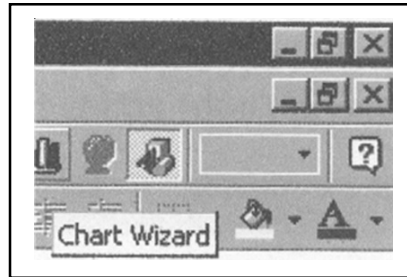

2. In Chart Wizard Step 1, select Standard Types, Column (you can play with Custom Charts at your leisure). Select the upper left box. Then use "next" to go to Step 2. Or you can double click on the box to go to the next step.

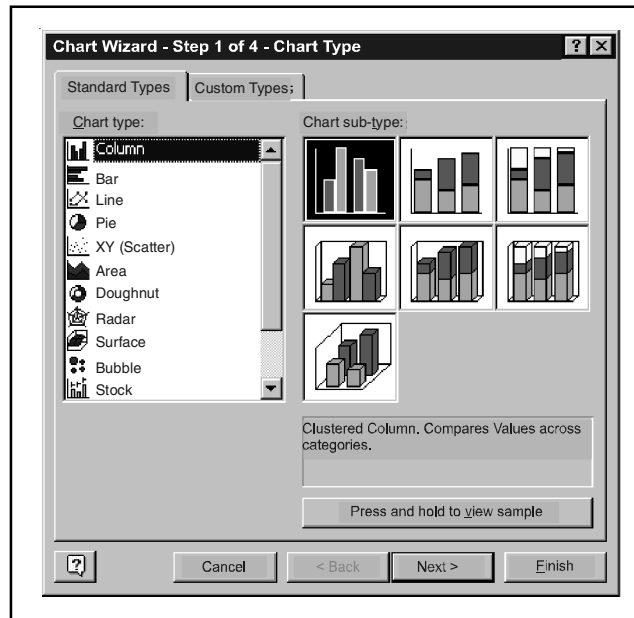

3. Step 2 in Chart Wizard causes problems for some students. You have the start of graph but there is much to do to get it just the way we want it.

Contd...

- (a) The Data Range dialog box is fairly self-explanatory. Notice the “Series in: Column” button is marked. Also notice the “=Sibling!” in the Data Range box; this indicates what worksheet the data is on. We don’t really need it in this example but it is necessary when we are working with more than one worksheet in an Excel workbook.

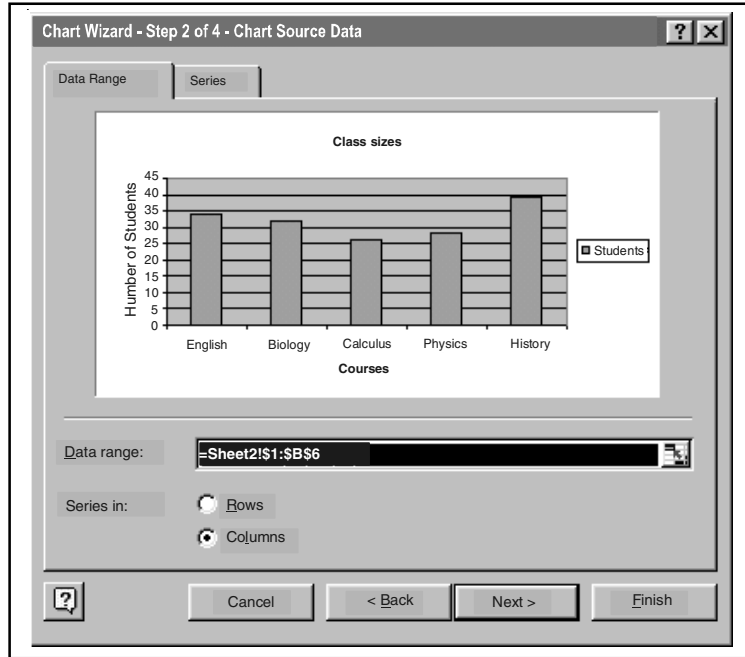

- (b) Now click the “Series” tab at the top. This is where we set up some of the X-axis format. “Series 1” refers to the data and is associated with both the chart legend and title. We’ll give it a name here just to try it out (we’ll modify it later however). Type “Siblings” in the empty Name space. You’re done in that box (don’t hit enter yet or you’ll go to step 3).

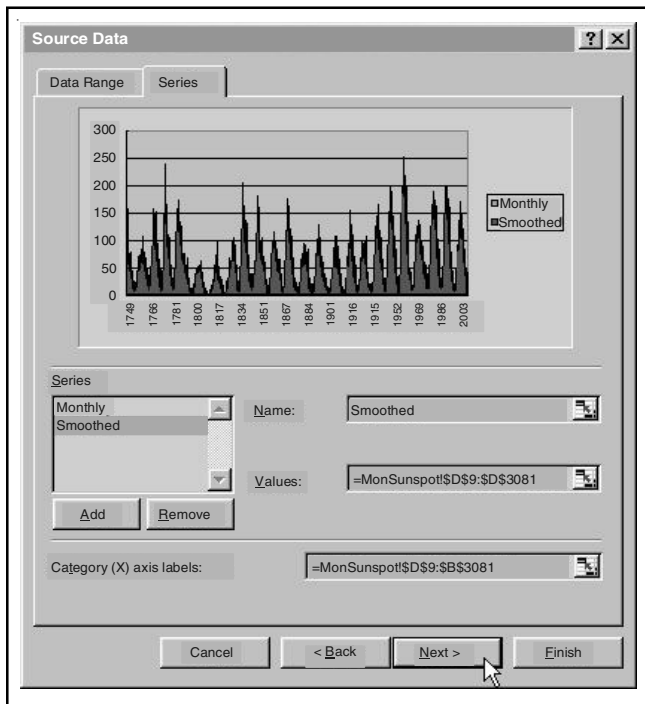

Contd...

Notes

- (c) Move your cursor to the Category X-axis labels box. This is an important feature; we assign the labels or categories to the X-axis here. One way is to type in the cells that contain our label names (or categories or numbers). Use the cells D3:D9 since they are the values of our random variables. You can use the red arrows or simply put your cursor in the box and highlight the appropriate cells. Click on “next” to go to Chart Wizard step 3.
- 4. In Chart Wizard Step 3 we continue formatting and labeling the graph. You don’t have to get it exactly right in this step as it is easy to modify the graph later. Title the graph “Number of Siblings”. Label the X-axis, “No. of Siblings”, and label the Y-axis “No. of Students”. Notice the other tabs at the top of this dialog box—Axes, Gridlines, Legend, etc. Look at each of these and experiment. Click on Next to go to the last step.
- 5. Step 4 in Chart Wizard asks whether we want the chart on the worksheet we are working with, in this case, Siblings, or put the graph on a new worksheet. Leave it on the “Siblings” worksheet and finish.
- 6. Adjust the graph to a convenient size. You do that by dragging the black squares, called sizing handles, found around the chart. If those squares aren’t there, you can make them appear by selecting the chart with a mouse click. Then reposition the chart to a convenient place on your worksheet.
- 7. You should now have a graph similar to the one below. Don’t worry too much if yours isn’t perfect. Part of your assignment for this module is to change it anyway.

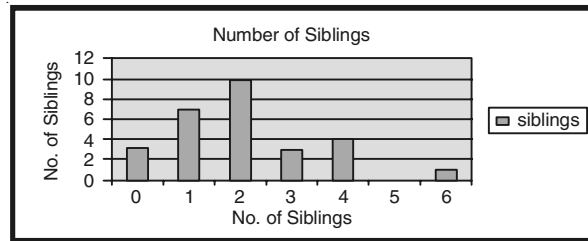

Questions:

1. Explain the concept of Histogram.
2. What is graphical representation of data?

2.3 Summary

- In octal number system there are only eight symbols or digits i.e. 0, 1, 2, 3, 4, 5, 6, 7, 8.
- In hexadecimal number system each position represents a power of the base 16.
- Graphical representation of data i.e. bar graph, excel chart wizard etc.

2.4 Keywords

Binary number system: It is like a decimal number system, except that the base is 2, instead of 10 which uses only two symbols (0 and 1).

n-bit number: An n-bit number is a binary number consisting of ‘n’ bits.

Decimal number system: In this system, the base is equal to 10 because there are altogether ten symbols or digits (0, 1, 2, 3, 4, 5, 6, 7, 8, and 9).

Memory dump: A commonly used way of doing this is to print memory contents on a printer. This printout is called a memory dump.

Notes



Lab Exercise

1. Explain one number system to another Conversion.

2.5 Self-Assessment Questions

1. The value range of one digit of octal duplicates the value range of three digits of binary.
 - (a) True
 - (b) False
2. A powerful computer is capable of performing several billion (10^9) arithmetic operation per second.
 - (a) True
 - (b) False
3. 3-digits bit number, i.e. 101 hasdecimal equivalent.
 - (a) 6
 - (b) 8
 - (c) 2
 - (d) 5
4. Memory dump is a printout of memory contents on a paper.
 - (a) True
 - (b) False

2.6 Review Questions

1. Find decimal equivalent of following binary numbers:
 - (a) 1101011
 - (b) 1000
 - (c) 10110011
 - (d) 11011101
 - (e) 1110101
 - (f) 1000
 - (g) 10110001100
 - (h) 110001
 - (i) 1010101100
 - (j) 111
2. Find octal equivalent of the binary numbers of Question 22.
3. Find hexadecimal equivalent of the binary numbers of Question 22.
4. Convert the following numbers to decimal numbers:
 - (a) 110110_2
 - (b) 2573_6
 - (c) $2A3B_{16}$
 - (d) 1234_9
5. Carry out the following conversions:
 - (a) $125_6 = ?_4$
 - (b) $24_9 = ?_3$
 - (c) $ABC_{16} = ?_8$

Notes

Answers to Self-Assessment Questions

1. (a)

2. (a)

3. (d)

4. (a)

2.7 Further Readings



Books

Fundamental Computer Concepts, William S. Davis.

Fundamental Computer Skills, Feng-Qi Lai, David R. Hofmeister.



Online link

<http://books.google.co.in/bkshp?hl=en>

Unit 3: Memory

CONTENTS

Objectives

Introduction

3.1 Unit of Memory

3.2 Types of Memory

3.2.1 RAM

3.2.2 ROM

3.2.3 PROM

3.2.4 EPROM

3.3 Summary

3.4 Keywords

3.5 Self-Assessment Questions

3.6 Review Questions

3.7 Further Readings

Objectives

After studying this unit, you will be able to:

- Understand the unit memory
- Discussed the various types of memory
- Explain the random access memory
- Discussed the read only memory
- Explained programmable red only memory
- Discussed about the checked memory and its components.

Introduction

CPU contains necessary circuitry for data processing controlling other components of the computer. However, one thing it does not have built into it is the place to store programs and data needed during data processing. CPU contains several registers for storing data and instructions but they can store only a few bytes at a time. They are just sufficient to hold only one or two instructions with corresponding data. If the instructions and data of a program being executed by a CPU were to reside in secondary storage like a disk, and fetched and loaded one by one into CPU registers as the program execution proceeded, this would lead to the CPU being idle most of the time. This is because there is a large speed mismatch between the rate at which CPU can process data and the rate at which data can be transferred from disk to CPU registers. For example, a CPU can process data at a rate of about 5 nanosecond/byte and a disk reader can read data at a speed of about 5

Notes

microseconds/byte. Hence, within the time in which a disk can supply one byte of data a CPU can process 1000 bytes. This would lead to a very slow overall performance even if a computer used a very fast CPU. To overcome this problem, there is a need to have a reasonably large storage space that can hold the instructions and data of the program(s) on which CPU is currently working time to fetch and load data from this storage space into CPU registers must also be very small as compared to that space from disk storage to reduce the speed mismatch problem with CPU speed. Every computer has such a storage space known as primary storage, main memory, or simply memory. It is a temporary storage area built into the computer hardware. Instructions and data of a program reside mainly in this area when CPU is executing the program. Physically, this memory consists of some integrated circuit (IC) chips either on the motherboard or on a small circuit board attached to the motherboard of a computer system. This built-in memory allows CPU to store and retrieve data very quickly. The rate of fetching data from this memory is of the order of 50 nanoseconds/byte. Hence, the rate of data fetching from main memory is about 100 times faster than that from a high speed secondary storage like disk.

3.1 Unit of Memory

Starting with the Unit of memory, you can see the difference between things like a “Kilobyte” and a “Megabyte” and other computer memory terms.

The charts below will give you a clear understanding of:

Name	Symbol	Binary Measurement	Decimal Measurement	Number of Bytes	Equal to
kilobyte	KB	2 ¹⁰	10 ³	1,024	1,024 bytes
megabyte	MB	2 ²⁰	10 ⁶	1,048,576	1,024 KB
gigabyte	GB	2 ³⁰	10 ⁹	1,073,741,824	1,024 MB
terabyte	TB	2 ⁴⁰	10 ¹²	1,099,511,627,776	1,024 GB
petabyte	PB	2 ⁵⁰	10 ¹⁵	1,125,899,906,842,624	1,024 TB
exabyte	EB	2 ⁶⁰	10 ¹⁸	1,152,921,504,606,846,976	1,024 PB
zettabyte	ZB	2 ⁷⁰	10 ²¹	1,180,591,620,717,411,303,424	1,024 EB
yottabyte	YB	2 ⁸⁰	10 ²⁴	1,208,925,819,614,629,174,706,176	1,024 ZB



Task

How many bytes in 2 GB describe with example?

3.2 Types of Memory

RAM, ROM, PROM and EPROM

3.2.1 Random Access Memory (RAM)

Notes

When people talk about computer memory, they usually mean the volatile RAM memory. Physically, this memory consists of some integrated circuit (IC) chips (see Figure 1.1) either on the motherboard or on a small circuit board attached to the motherboard. A computer's motherboard is designed in a manner that its memory capacity can be enhanced easily by adding more memory chips. Hence, if you decide to have more memory than your computer currently has, you can buy more memory chips and plug them in the empty memory slots on the motherboard. Service engineers normally do this job. The additional RAM chips which plug into special sockets on the motherboard, are known as *single in-line memory modules (SIMMs)*.

Figure 3.1: Random Access Memories (RAM)



3.2.2 Read-Only Memory (ROM)

A special type of RAM, called *read-only memory (ROM)*, is a non-volatile memory chip in which data is stored permanently and cannot be altered by usual programs. In fact, storing data permanently into this kind of memory is called “burning in the data” because data in such memory is stored by using fuse-links. Once a fuse link is burnt, it is permanent. Data stored in a ROM chip can only be read and used—they cannot be changed. This is the reason why it is called read-only memory (ROM). Since ROM chips are non-volatile, data stored in a ROM are not lost when power is switched off or interrupted unlike in the case of a volatile RAM chip. ROM is also known as field stores, permanent stores, or dead stores.

ROMs are mainly used to store programs and data that do not change and are frequently used. Most basic computer operations are carried out by wired electronic circuits. However, several higher-level and frequently used operations require very complicated electronic circuits for their implementation. Hence, instead of building electronic circuits for these operations, special programs are written to perform them. These programs are called *micro programs* because they deal with low-level machine functions and are essentially substitutes for additional hardware. ROMs are used by computer manufacturers to store these micro-programs so that they cannot be modified by the users.

A good example of a micro-program is the set of instructions needed to make a computer system ready to use when it is powered on. This micro-program, called “system boot program”, contains a set of start-up instructions to check if the system hardware like memory, I/O devices, etc. are functioning properly. It looks for an operating system and loads its core part in the volatile RAM of the system to produce the initial display-screen prompt. Note that this micro-program is used every time the computer is switched on and needs to be retained when the computer is switched off. Hence, ROM is an ideal storage for storing it.

Notes

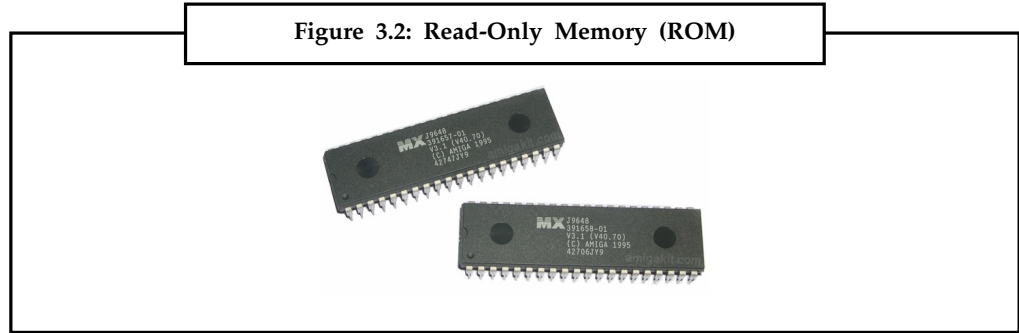

3.2.3 Programmable Read-Only Memory (PROM)

There are two types of read-only memory (ROM) - manufacturer-programmed and user-programmed. A *manufacturer-programmed ROM* is one in which data is burnt in by the manufacturer of the electronic equipment in which it is used. For example, a personal computer manufacturer may store the system boot program permanently in a ROM chip located on the motherboard of each PC manufactured by it. Similarly, a printer manufacturer may store the printer controller software in a ROM chip located on the circuit board of each manufactured by it. Manufacturer-programmed ROMs are used mainly in those cases where the demand for such programmed ROMs is large. Note that manufacturer-programmed ROM chips are supplied by the manufacturers of electronic equipment and it is not possible for a user to modify the programs or data stored in a ROM chip. On the other hand, a *user-programmed ROM* is one in which a user can load and store “read-only” programs and data. That is, it is possible for a user to “customize” a system by converting his/her programs to micro-programs and storing them in a user-programmed ROM chip. Such a ROM is commonly known as *Programmable Read-Only Memory (EPROM)* because a user can program it. Once the user programs are stored in a PROM chip they can be executed usually in a fraction of the time previously required. PROMs are programmed to record information using a special device known as PROM-programmer. However, once the chip has been programmed, the PROM become a ROM. That is, the information recorded in it can only be read (it cannot be changed). PROM is also non-volatile storage, i.e., the stored information remains intact even if power is switched off or interrupted.

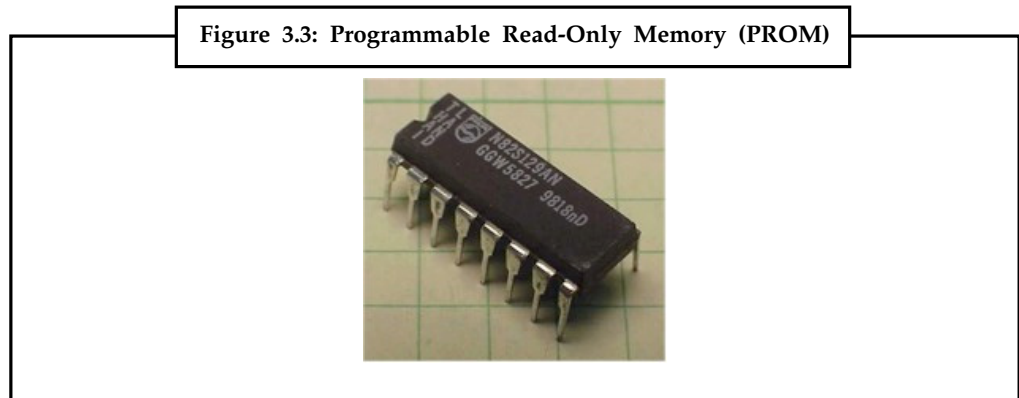

3.2.4 Erasable Programmable Only Memory (EPROM)

Once information is stored in a ROM or PROM chip it cannot be altered. Erasable Programmable Read-Only Memory (EPROM) overcomes this problem. As the name implies,

it is possible to erase information stored in an EPROM chip and the chip can be reprogrammed to store new information. EPROMs are often used by R&D personnel (experimenters) who frequently change the micro-programs to test the efficiency of a computer system with new programs. EPROMs are also useful for those applications in which one may like to store a program in a ROM that would normally not change but under some unforeseen conditions, one may like to alter it. When an EPROM is in use, information stored in it can only be “read” and the information remains in the chip until it is erased.

EPROM chips are of two types—one in which the stored information is erased by exposing the chip for some time of ultraviolet light and the other one in which the stored information is erased by using high voltage electric pulses is known as Ultra Violet EPROM ((UVEPROAM) and the latter is known as Electrically EPROM (EEPROM).It is easier to alter information stored in an EEPROM chip as compared to an UVEEPROM chip. EPROM is also known as flash memory because of the ease with which programs stored in it can be altered. Flash memory is used in many new I/O and storage devices like USB (Universal Serial Bus) pen drive and MP3 music player.

Figure 3.4: Erasable Programmable Only Memory (EPROM)



3.2.5 Cache Memory

Use of main memory helps in minimizing disk-processor speed mismatch to a large extent because the rate of data fetching by a computer’s CPU from its main memory is about 100 times faster than that from a high-speed secondary storage like disk. However, even with the use of main memory, memory-processor speed mismatch becomes a bottleneck in the speed with which the CPU can process instructions because there is a 1 to 10 speed mismatch between the processor and memory. That is, the rate at which data can be fetched from memory is about 10 times slower than the rate at which CPU can process data. Obviously, the overall performance of a processor can be improved greatly by minimizing the memory-processor speed mismatch. Cache memory (pronounced “cash” memory) is commonly used for this purpose. It is an extremely fast, small memory between CPU and main memory whose access time is closer to the processing speed of CPU. It acts as a high-speed buffer between CPU and main memory and is used to temporarily store very active data and instructions during processing. Since cache memory is faster than main memory, processing speed is improved by making the data and instructions needed for current processing available in the cache. *Cache memory* is an extremely fast and small memory between CPU and main memory. Its access time is closer to the processing speed of CPU. It acts as a high-speed buffer between CPU and main memory and is used to temporarily store very active data and instructions during processing.

Notes

Figure 3.5: Cache Memory

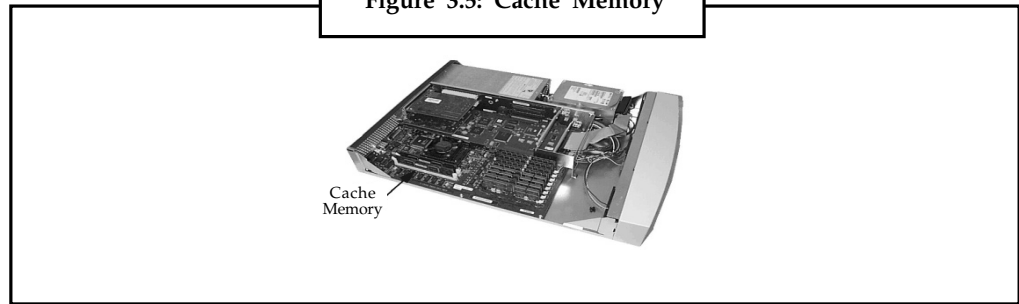

Task

What is different between catch memory and RAM?



Case Study

Timeline of Computer Memory

- 1834:** Charles Babbage begins build his “Analytical Engine”, Precursor to the computer. It uses read-only memory in the form of punch cards.
- 1932:** Gustav Tauschek invents drum memory in Austria.
- 1936:** Konrad Zuse applies for a patent for his mechanical memory to be used in his computer. This computer memory is based on sliding metal parts.
- 1939:** Hepmut Schreyer invents a prototype memory using neon lamps.
- 1942:** The Atanasoff-Berry Computer has 60 50-bit words of memory in the form of capacitors mounted on two revolving drums. For secondary memory it uses punch cards.
- 1947:** Frederick Viehe of Los Angeles, applies for a patent for an invention that uses magnetic core memory, Magnetic drum memory is independently invented by several people.
- 1949:** Jay Forrester conceives the idea of magnetic core memory as it is to become commonly used, with a grid of wires used to address the cores. The first practical form manifests in 1952-53 and renders obsolete previous types of computer memory.
- 1950:** Ferranti Ltd. completes the first commercial computer with 256 40-bit words of main memory and 16K words of drum memory. Only eight were sold.
- 1951:** Jay Forrester files a patent for matrix core memory.
- 1952:** The EDVAC computer is completed with 1024 44-bit words of ultrasonic memory. Acore memory module is added to the ENIAC computer.
- 1955:** An Wang was issued U.S. patent #2,708,722 with 34 claims for magnetic memory core.
- 1966:** Hewlett-Packard releases their HP2116A real-time computer with 8K of memory. The newly formed Intel starts sell a semiconductor chip with 2,000 bits of memory.
- 1968:** USPTO grants patent 3,387,286 to IBM’s Robert Dennard for a one-transistor DRAM cell. DRAM stands for Dynamic RAM (Random Access Memory) or Dynamic

Contd...

Random Access Memory. DRAM will become the standard memory chip for personal computers replacing magnetic core memory.

Notes

Questions:

1. Give the name of Analytical Engine beginner.
2. Tell the time line of 8 KB memory computer.

3.3 Summary

- CPU contains necessary circuitry for data processing.
- Computer mother board is designed in a manner that its, memory capacity can be enhanced easily by adding more memory chips.
- Micro programs, they are the special programs for building electronic circuit to perform operations.
- Manufacturer programmed; ROM is one in which data is burn in the menu facture of electronic unit/equipment in which it is used.

3.4 Keywords

Single line memory modules: The additional RAM clip which plug into special sockets on the mother board.

PROM: Programed Rom is one in which data is burnt in by the manufacturer of the electronic equipment in which it is used.

Ultra violet EP-ROM (UVEPOAN): It is one in which the stored information is erased by using high voltage electric pulses.

Cache memory: It is used to temporarily store very active data and instructions during processing.



Lab Exercise

1. Define output device.
2. Define all Secondary storage devices.

3.5 Self-Assessment Questions

1. The additional RAM chips which plug into special sockets on the mother board are known as

(a) SIMMs	(b) SIMs
(c) PROM	(d) All of these
2. These are two types of read-only memory (ROM) manufacture-programmed and user program.

(a) True	(b) False
----------	-----------
3. Which programme are mainly used to store programme and data that do not changed are frequently used.

(a) RAMs	(b) ROMs
----------	----------

Notes

4. PROM is one in which data is burnt in by the manufacturer of the electronic equipment in which it is used.
(a) True (b) False
5. Megabytes (MB) is equal to 1,048,576 (2^{20}).
(a) True (b) False

3.6 Review Questions

1. Explain unit of memory.
2. Define memory and its types.
3. What is ROM? Explain with suitable figure.
4. What is EPROM? Explain with suitable examples.
5. Difference between RAM and ROM.

Answers for Self-Assessment Questions

1. (a)
2. (a)
3. (b)
4. (a)
5. (a)

3.7 Further Readings



Books

Fundamental Computer Skills, Feng-Qi Lai, David R. Hofmeister.
A Study of Computer Fundamental, Shu-Jung Yi.



Online link

<http://books.google.co.in/bkshp?hl=en>

Unit 4: Secondary Storage Devices

CONTENTS

Objectives

Introduction

4.1 Secondary Storage Devices

4.1.1 Sequential and Direct-Access Devices

4.1.2 Optical Disk Drive

4.2 Input/Output Device

4.2.1 Input Devices

4.2.2 Output Devices

4.3 Latest Input Devices in Market

4.4 Latest Output Devices in Market

4.5 Summary

4.6 Keywords

4.7 Self-Assessment Questions

4.8 Review Questions

4.9 Further Readings

Objectives

After studying this unit, you will be able to:

- Explaion of the secondary storage device
- Understanding of input and output devices in computer
- Know ledge and understanding of latest input devices in market
- Knowledge of latest output devices in market

4.1 Secondary Storage Devices

Secondary storage devices, as indicated by the name, save data after it has been saved by the primary storage device, usually referred to as RAM (Random Access Memory). From the moment you start typing a letter in Microsoft Word, for example, and until you click on "Save", your entire work is stored in RAM. However, once you power off your machine, that work is completely erased, and the only copy remaining is on the secondary storage device where you saved it, such as internal or external hard disk drive, optical drives for CDs or DVDs, or USB flash drive.

Primary storage of a computer system has following limitations:

1. **Limited Capacity.** It is often necessary to store many millions, sometimes billions, and even trillions, of bytes of data in a computer. Unfortunately, the storage capacity of

Notes

primary storage of today's computers is not sufficient to store the large volume of data handled by most data processing centers.

2. **Volatile.** Primary storage is volatile and the data stored in it is lost when power is turned off or interrupted. However, computer systems need to store data on permanent basis for several days, several months, or even several years.

As a result, additional memory, called auxiliary memory or secondary storage, is used with most computer system. Secondary storage is non-volatile and has lower cost per bit stored but it generally has an operating speed far slower than that of primary storage. It is used primarily to store large volume of data on permanent basis that can be partially transferred to primary storage, whenever required for processing.

Over the years, several devices and media have been used as secondary storage in computer systems. Many of them such as punched paper tape and punched cards have become obsolete now. They are magnetic tape, magnetic disk, optical disk, and memory storage devices. In this chapter, you will learn about the terminologies, principles of operation, uses, and trade-offs of different types of secondary storage devices.

4.1.1 Sequential and Direct-Access Devices

Several different devices can be used as a secondary storage device but the one selected for a particular application depends mainly upon how the stored information needs to be accessed. There are two methods of accessing information—sequential or serial access, and direct or random access. A sequential-access storage device is one in which the arrival at desired location may be preceded by sequencing through other location so that access time varies according to location. That is, information on a sequential-access device can be retrieved in the same sequence only in which it is stored. Sequential processing is suitable for such applications like preparation of monthly pay slips, monthly electricity bills, etc. where most, if not all, of the data records need to be processed one after another. In these applications, data records for every employee or customer needs to be processed at scheduled intervals (in this case monthly). However, while working with a sequential-access device for if an address is required out of order, it can be reached only by searching through all the addresses stored before. For instance, data stored at the last few locations cannot be accessed until all preceding locations in the sequence have been traversed. This is analogous to a music tape cassette. If 10 songs are recorded on a music tape and you want to listen to (or access) the eighth song, you must first listen to (or access) the seven songs coming before your favorite song. Your player may “fast forward” the tape quickly past the first seven songs but the first seven songs are still accessed, although, not fully played. In the same way, to access the 28th data record stored on a sequential-access device a computer must first access (although not process) the first 27 data records. Magnetic tape is an example of a sequential-access storage device. In many applications, we need to access information in a more direct manner than sequential-access device allow. For example, in a computerized bank, at any instance, it may be required to determine the exact balance in the savings account of a customer. Similarly, in a computerized airline ticket booking system immediate access may be required to reservation system records to find out if seats are currently available on a particular flight in such applications, if we use a sequential-access device for data storage, the time taken to access the desired information may be long enough to cause frustration to the customer. Secondary storage devices exist that permit access to individual information in a more direct or immediate manner. These direct-access devices are also called random-access devices because out of all the information stored, any randomly chosen piece of information can be accessed immediately. Hence, a random-access storage device is one in which any location in the device may be selected at random, access to the information stored is direct, and approximately equal access time is required for each location. This is analogous to a music CD. If 10 songs are recorded on a music CD and you want listen (or access) the sixth song, you need not listen to or fast-forward the five songs coming before your favorite song. All you have to do is select track number six on the player and the player directly

moves the pickup arm access the CD to the groove where the sixth song begins and starts playing. Magnetic disks, optical disks, and memory storage devices are examples of direct-access storage devices.

Notes

4.1.1.1 Hard Disks

Hard disks are the primary on-line secondary storage device for most computer systems today. They are made of rigid metal (frequently aluminum) platters and come in many sizes ranging from 1 to 14-inch diameter.

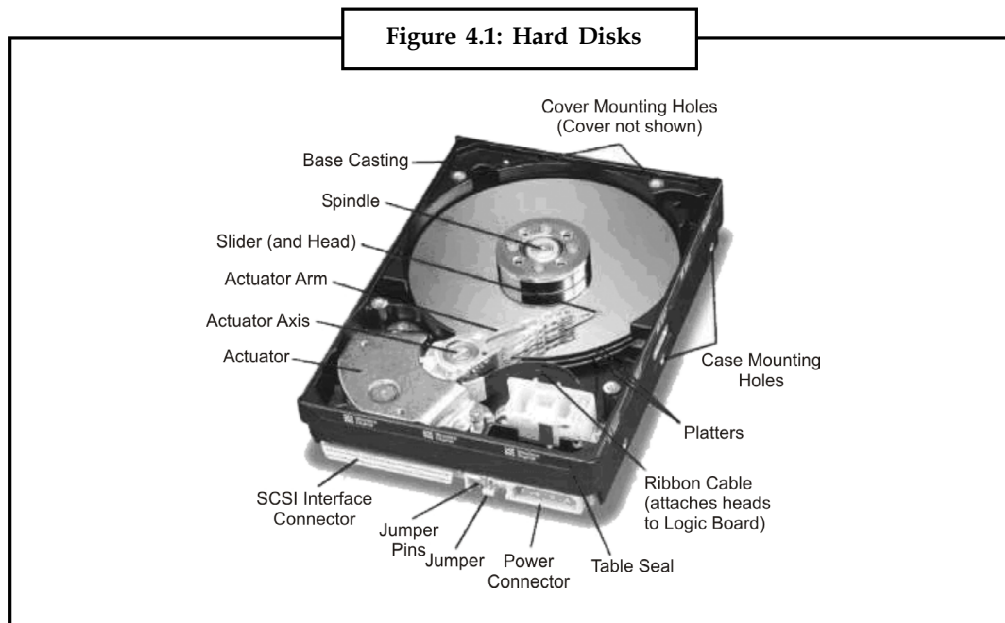

Types of Hard Disks

Depending on how they are packaged, hard disks are normally categorized into three types:

1. **Zip/Bernoulli Disk.** It consists of a single hard disk platter encased in a plastic cartridge. The disk commonly of 3½-inch size having storage capacity of about 100 MB. The storage capacity slightly varies depending on the formatting style used by a computer system with which it is used. Its disk drive, called *zip drive*, may be of portable or fixed type. The fixed type is part of a computer system permanently connected to it. The portable type can be brought and connected to a computer for the duration of use and can then be disconnected and taken away. A zip disk can be easily loaded/unloaded into a zip drive just as we insert/remove a floppy disk in a floppy disk drive or a video cassette in a VCR.

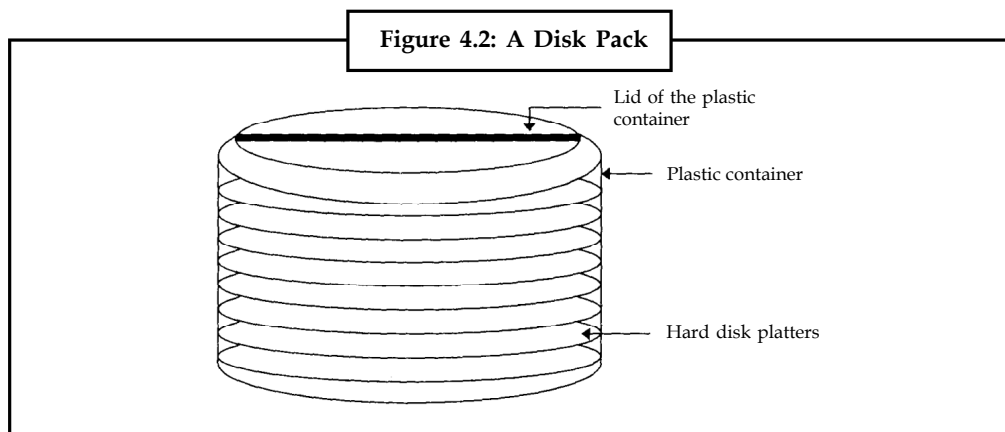

Notes

2. **Disk Pack.** It consists of multiple (two or more) hard disk platters mounted on a single central shaft. All the disks revolve together at the same speed. Its disk drive has a separate read/write head for each usable disk surface (recall that when multiple disks are used together in a disk device, the upper surface of the topmost disk and the lower surface of the bottommost disk are sometimes not used). Its disk drive is of interchangeable type and allows loading/unloading of different disk packs as and when they are to be used. When not in use, a disk pack is stored off-line in a plastic case (see Figure 4.2). This gives virtually unlimited storage capacity to disk packs.
3. **Winchester Disk.** A Winchester disk consists of multiple (two or more) hard disk platters mounted on a single central shaft. However, unlike a disk pack drive, a Winchester disk drive is of fixed type. That is, its hard disk platters and disk drive are sealed together in a contamination-free container and cannot be separated from each other. Hence, Winchester disks have limited capacity. However, for the same number of disk platters of the same size, Winchester disks can have larger storage capacity than disk packs due to following reasons:
 - (a) As both disk platters and disk drive are permanently sealed together, all surfaces of all disk platters (including the upper surface of the topmost platter and the lower surface of the bottommost platter) are used for data recording in a Winchester disk. That is, for a Winchester disk with four platters there are eight usable surfaces as opposed to six surfaces in case of a disk pack with four platters.
 - (b) The contamination-free environment allows Winchester disks to employ greater precision of data recording and accessing, resulting in greater data storage density than interchangeable disk packs.

Winchester disks were so named after the 30-30 Winchester rifle because the early Winchester disk systems had two 30-MB disks. Storage capacity of today's Winchester disks ranges from a few tens of megabytes to a few gigabytes (10^9 bytes).

4.1.1.2 Flash Drive (Pen Drive)

Flash drive is a compact device of the size of a pen, comes in various shapes and stylish designs (such as pen shape, wallet shape, etc.), and may have different added features (such as with a camera, with a built-in N1P3IWMA/FM Radio play back for music on the go, etc.). It enables easy transport of data from one computer to another. It is a plug-and-play device that simply plugs into a USB (Universal Serial Bus) port of a computer. The computer detects it automatically as removable drive. Now one can read, write, copy, delete, and move data from the computer's hard disk drive to the flash drive or from the flash drive to the hard disk drive. One can even run applications, view videos, or play MP3 files from it directly. Once done, it can be simply plugged out of the USB port of the computer and kept into the pocket for being carried anywhere. A flash drive does not require any battery cable, or software, and is compatible with most PCs, desktop, and laptop computers with USB 2.0 port. All these features make it ideal external data storage for mobile people to carry or transfer data from one computer to another. As the name implies, it is based on *flash memory* storage technology. Recall that flash is non-volatile, Electrically Erasable Programmable Read Only Memory (EEPROM) chip. It is a highly Aid-state storage having data retention capability of more than 10 years.

Available storage capacities are 8MB, 16MB, 64MB, 128MB, 256MB, 512MB, 1GB, 2GB, 4GB, and 8GB. A : of 16MB capacity has 5600 times more storage capacity than a IAMB floppy disk.

Figure 4.3: A Flash Drive (pen drive)



Notes

Figure 4.3 shows a flash drive. It has a main body and usually a port connector cover. The cover is removed or port connector is pushed out when the drive is to be plugged into the USB port of a computer. The main body usually has a write protect tab, a read/write LED (Light Emitting Diode) indicator, and a strap hole. Some manufacturers also provide software to be used with the drive.

4.1.2 Optical Disk Drive

An optical disk is mounted on an optical disk drive for reading/writing of information on it. An optical disk drive contains all the mechanical, electrical, and electronic components for holding an optical disk and for reading/writing of information on it. That is, it contains the tray on which the disk is kept, read/write laser beams assembly and motor to rotate the disk. Figure 4.4. shows an optical disk drive.

Figure 4.4: Optical Disk Drive

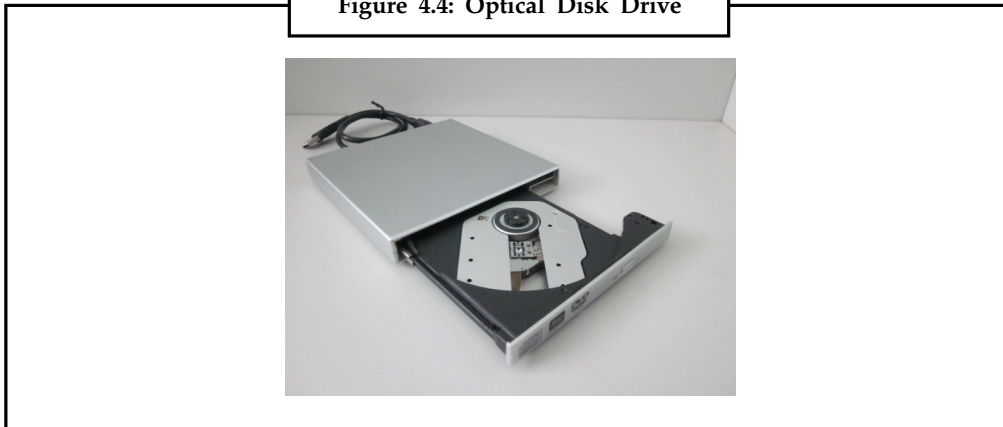

Access Time

Optical disk drives are slower (have larger access time) than magnetic disk drives due to following reasons:

1. The sectors of an optical disk are arranged on a continuous spiral track. This data organization results in slower random access of a sector than the concentric tracks organization (used by magnetic disks) because in case of concentric tracks, sectors are always found on a given track at a fixed distance from the center.

Notes

2. In case of optical disks, each sector has the same length regardless of its position from the center. This data organization requires a more complicated drive mechanism because disk's rotation speed must vary inversely with the radius. That is, the drive must slow down disk's rotation speed to read/write sectors towards the outside of the disk and speed it up to read/write sectors towards the center of the disk. This access mechanism leads to slower data access (larger access time) as compared to magnetic disks in which case the disks rotate at a constant speed irrespective of the location of the data to be accessed.
3. Since optical disk is a removable media, it is prone to scratches, dust, sticky prints (including fingerprints), etc. while handling. This causes the read mechanism to employ error correction mechanisms, like re-read, varying angular velocity, data reconstruction using parity, etc.
4. The entire read/write and disk assembly is not a sealed unit. Hence, the disk drive cannot spin the disk at fast speed as it may damage the disk and other parts.

Access times for optical disks are in the range of 100 to 300 milliseconds. Compare this with the access times of floppy disks, which are in the range of 100 to 200 milliseconds, and that of hard disks, which are in the range of 10 to 30 milliseconds.

4.1.2.1 Types of Optical Disks

All optical disks are round platters. They come in different sizes and capacities. Commonly used types of optical disk are CD-ROM, WORM (CD-R), CD-RW, and DVD disks. They are described below.

CD-ROM

CD-ROM stands for Compact Disk-Read-Only-Memory. It is a spin-off of audio CD technology and works much like audio CDs used in music systems. In fact, if your computer has sound card and speakers, you can play audio CDs with your computer.

CD-ROM disk is a shiny, silver color metal disk usually of 5/4-inch (12 cm) diameter. It is made of polycarbonate plastic and thin layer of pure aluminum is applied to make the surface reflective. For some very good quality disks, gold layer is used. A thin layer of lacquer protects it. It has storage capacity of about 650 Megabytes or 700 Megabytes in newer ones. It is so called because of its large storage capacity on a compact-size disk and because it is a read-only storage medium. "That is, these disks come pre-recorded and information stored on them cannot be altered.

Since an optical disk is read from the center to outer edge, several sizes are possible. Apart from the most common 120mm 74/8 minute disk having storage capacity of 650 MB to 700 MB, 80mm 21 minute disk (called Mini-CD) having 184 MB storage is also available. They can be used with the disk drive of a 120 mm disk. Mini CDs are designed in various fancy shapes like round, oval, triangle, etc., while ensuring that the storage area is affected.

WORM Disk/CD-Recordable (CD-R) Disks

WORM stands for write-once, read-many. WORM disks allow users to create their own CD-ROM disks by using a CD-recordable (CD-R) drive attached to a computer as a regular peripheral device. WORM disks look like standard CD-ROM disks, are purchased blank, and later encoded using a CD-R drive. The information recorded on a WORM disk by a CD-R drive can be read by any ordinary CD-ROM drive. As the name implies, data can be written only once on a WORM disk but can be read many times. That is, like a CD-ROM disk, once

data has been etched on the surface of a WORM disk it becomes permanent and can be read but never altered. However, all the data to be recorded on a WORM disk can be written on its surface in multiple recording sessions. The session after the first one are always additive and cannot alter the etched/burned information of earlier sessions. The information added in a session can be hidden in a subsequent session by creating the File Allocation Table (FAT) at a new location but the etchings on the surface cannot be removed. Such disk is called Multi-Session Disk. Laser beam technology (discussed earlier) is used for data recording/reading.

CD Read/Write (CD-RW) Disk

A CD Read/Write (CD-RW) disk is very similar to a WORM disk with the exception that you can erase the previous content and write on it multiple times. Such disks use metallic alloy layer. Laser beam changes the chemical property during writing (or *burn* process) changing reflectivity at desired places. The land-pit difference on CD-RW is not significant and hence CD drives have to be compatible to read such disks. A CD-RW disk usually has a lifetime of 100 or more erase-write cycle. A disk written once can be erased by changing by the chemical property again and then it can be written on to afresh. CD-RW drives have such erase capability. CD-RW disks are little expensive than CD-R disks but are a great cost saver because they can be reused many times due to their erase capability.

Digital Video (or Versatile) Disk (DVD)

DVD was designed primarily to store and distribute movies. However, it is fast becoming mainstream optical disk as prices are reducing and need for large capacity storage is increasing. It is similar to CD-ROM in principle but is denser in recording data. It follows Eight-to-Fourteen Modulation Plus %1Plus encoding as compared to Eight-to-Fourteen Modulation (EFM) encoding used by CD-ROM. There are variants of DVD—single-layer disk and double-layer disk. Single-layer disk has storage capacity of 4.7GB, whereas, double-layer disk has storage capacity of 8.5 GB.

- Like CD-ROM, DVD also has many types—DVD-R/RW, DVD+R/RW, DVD-Video, and DVD-Audio. DVD-Video is now the most dominant movie storage format used. It allows storage of video in 4:3 or 16:9 aspect ratios in MPEG-2 video format using NTSC or PAL resolution. It may be of interest to note that NTSC has resolution of 720 x 576 and PAL has resolution of 720 x 576. The audio is usually Dolby Digital (AC-3) or Digital Theater system (DTS) and can be either monaural or 5.1 Surround Sound.

DVD has enough space to store movie and support multi-lingual subtitles, multi-lingual audio, multiple camera, angles etc. It also supports region marking to protect against piracy and use of DVD from one region to another. It also supports Content Protection for Prerecorded Media (CPPM) security technique to safe guard against n; etc.

4.1.2.2 Advantages and Limitations of Optical Disks

Advantages

1. Cost-per-bit of storage for optical disks is very low because of their low cost and high storage density. Additional cost benefit comes from the fact that some optical disks can be erased and reused many times.
2. Use of a single spiral track makes optical disks an ideal storage medium for reading large blocks of sequential data such as audio or video.

Notes

3. Optical disk drives do not have any mechanical read/write heads to rub against or crash into the disk surface. This makes optical disks more reliable storage medium than magnetic tapes or magnetic disks.
4. Optical disks have data storage life in excess of 30 years. This makes them better storage medium for data archiving as compared to magnetic tapes or magnetic disks.
5. Since data once stored on CD-ROM/WROM disks becomes permanent, the danger of stored data getting inadvertently erased/overwritten is not there.
6. Due to their compact size and lightweight, optical disks are easy to handle, store, and port from one place to another.
7. Audio CDs can be played on a computer having a CD-ROM drive along with a sound card and speakers. This allows computer systems to be also used as music systems, whenever desired.
8. A computer having a DVD drive can be used to play DVDs allowing it to be used for watching videos such as movies.

Limitations

1. CD-ROM and WORM disks are read-only (permanent) storage medium. Data once recorded, cannot be erased. Hence, they cannot be reused.
2. Data access speed for optical disks is slower than magnetic disks.
3. Optical disks require more complicated drive mechanism than magnetic disks due to the need to have laser generating source and detection lens that require precision engineering and careful handling.
4. Since optical disk is a removable media, it is prone to scratches, dust, sticky prints (including fingerprints), etc. while handling. Hence, they need careful handling.
5. When used for off-line storage, they should be labeled properly for easy identification.

4.1.2.3 Uses of Optical Disks

Optical disks are used for following purposes:

1. For distributing large amounts of data at low cost. For example, a complete encyclopedia, dictionary, world atlas, dictionary of quotations, biographies of great people, information about all educational institutions of a particular type in a country, etc. are often distributed on CD-ROM disks.
2. For distribution of electronic version of conference proceedings, journals, magazines, books, product catalogs, etc.
3. For distribution of audio such as songs.
4. For distribution of new or upgraded versions of software products by software vendors.
5. For storage and distribution of wide variety of multimedia applications such as video games.
6. For archiving of data not used frequently but which may be used occasionally.
7. WORM disks are often used by end-user companies to make permanent storage of their own proprietary information. For example, many banks use them for making a permanent record of their daily transactions.
8. DVDs have become a popular medium for distribution of movies.

4.2 Input/Output Device

Notes

To be useful, a computer system needs to communicate with its external environment (its users). The input-output devices (abbreviated *I/O devices*) provide this capability to a computer system (See Figure 4.5). They are known as *peripheral devices* because they surround a computer's CPU and memory. Input devices are used to enter data from outside world into primary storage, and output devices supply the results of processing from primary storage to users. A wide variety of I/O devices is now available. For a particular application, one type may be more suitable than another type. Some devices are used for both input and output function.

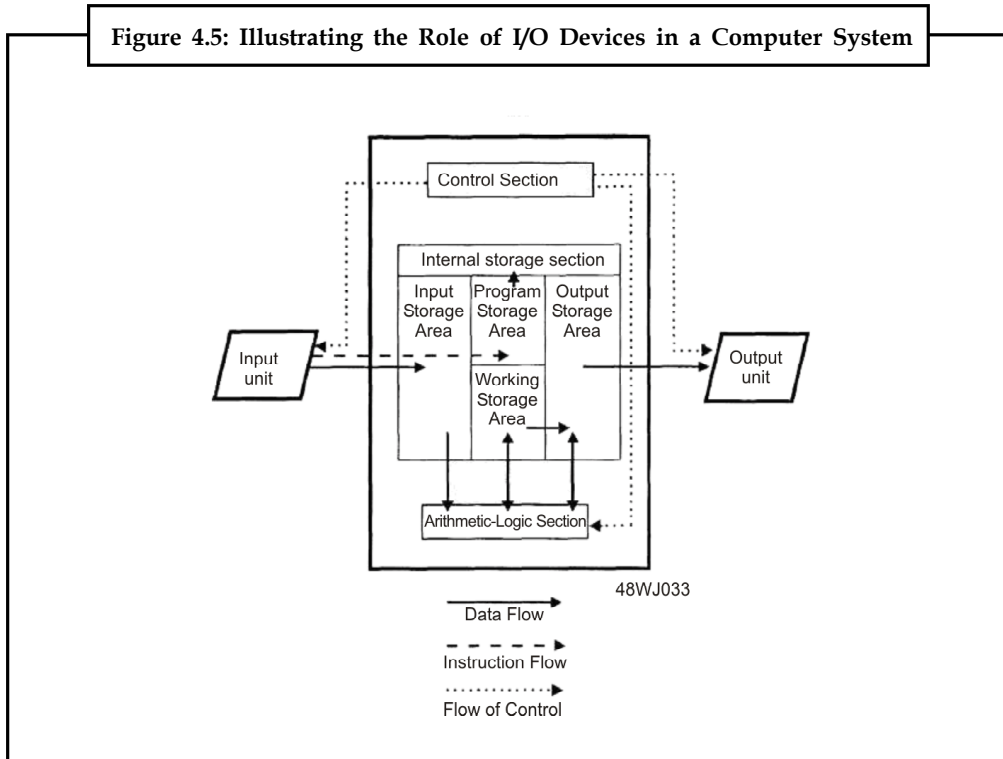

It is important to note that the speed of I/O devices is very slow as compared to the speed of primary storage and CPU. This is because their speed in most cases depends on the movement of mechanical parts, and the potential for improvement in speed of such parts is limited. It is, therefore, difficult to produce I/O devices that can match processor and memory speeds, and there is a constant demand for faster and faster I/O devices.

4.2.1 Input Devices

An input *device* is an electromechanical device that accepts data from outside world and translates them into a computer can interpret. Several input devices are available today. They can be broadly classified into following categories:

- Keyboard devices
- Point-and-draw devices
- Data scanning devices

Notes

- Digitizer
- Electronic cards based devices
- Speech recognition devices
- Vision based devices

Various types of input devices along with their applications are described below.

4.2.1.1 Keyboard Devices

Keyboard devices are the most commonly used input devices today. They allow data entry into a computer system by pressing a set of keys (labeled buttons) neatly mounted on a keyboard connected to a computer system. The popular keyboard used today is the 101-keys *QWERTY* keyboard.

Figure 4.6: The Layout of Keys on a QWERTY Keyboard

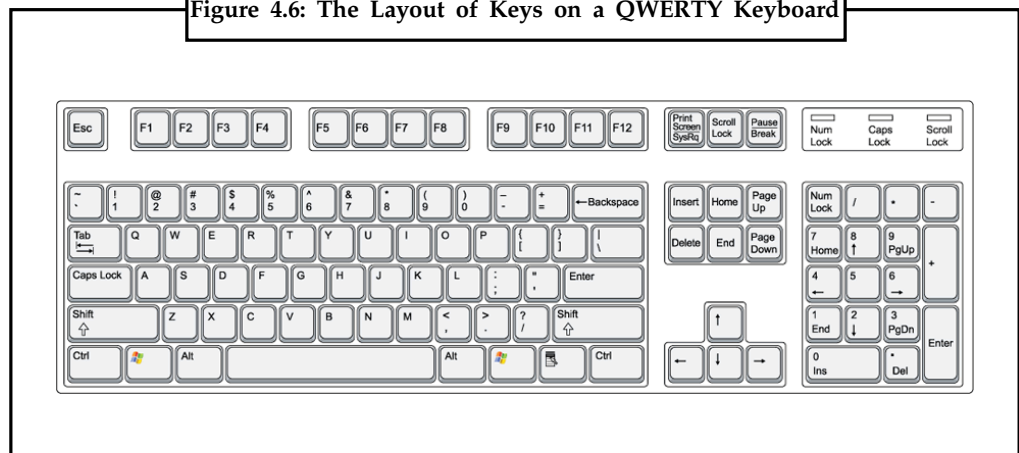

4.2.1.2 Point and Draw Device

Interaction with computers was initially restricted mainly to text mode. However, it was soon realized that interacting with computers in text-mode is cumbersome and time-consuming. Hence, a new type of user interface called graphical user interface (GUI), was devised for interacting with computers. A GUI provides a screen with icons (small images on the screen) or menus and allows a user to make rapid selections from them to give instructions to a computer. For efficient utilization, OUI requires an input device that can be used rapidly point to and select a graphic icon or menu item from the multiple options displayed on the screen. The keyboard though usable, was found to be inconvenient and unsuitable for this requirement. Hence, research efforts to find a suitable input device to meet this requirement gave birth to several input devices like mouse, track ball, joystick, light pen, and touch screen. Later it was realized that many of these devices, like mouse and light pen, could also be used very effectively to create graphic elements on the screen such as lines, curves, and freehand shapes. With this new ability, these devices came to be known as point-and-draw devices. These input devices have made computers a much more easily usable tool establishing them as a versatile tool for a wide range of users including children, illiterate citizens, and graphic designers. Some commonly used point-and-draw devices are described below.

Figure 4.7: Point and Draw Device

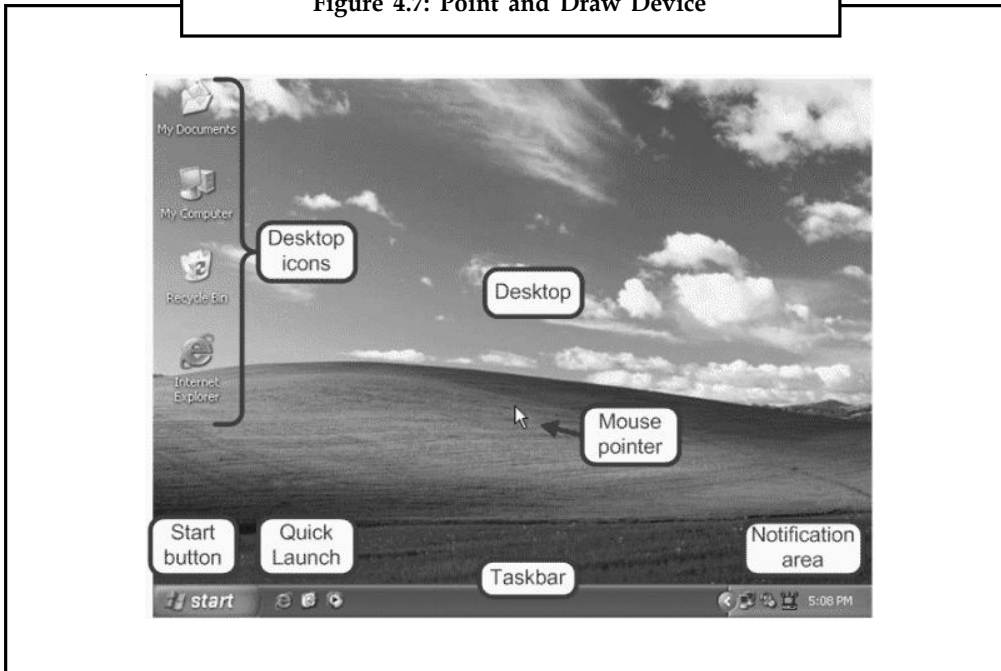

4.2.1.3 Mouse

Mouse is the most popular point-and-draw device. It is a must-have input device on modern personal computers and workstations because they support GUI as their primary user interface. A mouse is a small hand-held device that fits in a user's palm comfortably. It rolls on a small bearing and has one or more buttons on the top. When a mouse that is connected to a user terminal is rolled on a flat surface, a graphics cursor moves on the terminal screen in the direction of the mouse's movement. Since all movements of the mouse are reproduced by the graphics cursor on the screen, you can move the graphics cursor at a menu item or an icon by moving the mouse.

Figure 4.8: Mouse

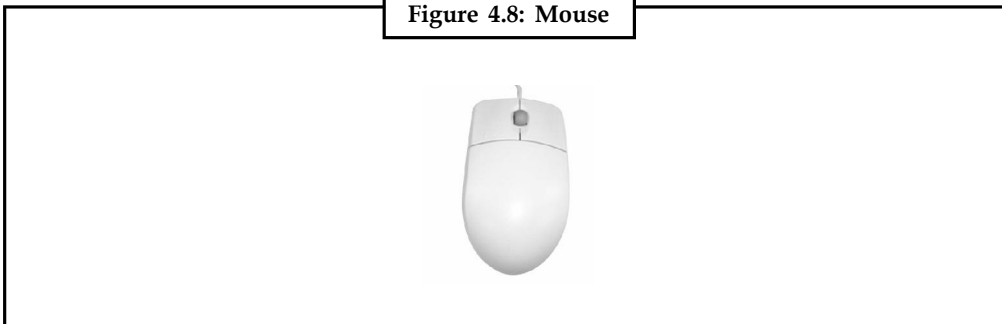

The graphical *cursor* is displayed as a variety of symbols such as an arrow, a wrist pointing finger etc. Depending on the application, the text and graphics cursor may be displayed on the screen at the same time. The graphics cursor, irrespective of its size and shape, has a pixel-size point that is considered the point of reference to decide where the cursor is positioned on the screen. This point is called *hot-spot* of the graphics cursor when the hot-spot is positioned at a menu item or an icon, the graphics cursor is said to point

Notes

to that menu item or icon. With a click of the mouse's button, the system can then be notified of this choice. Note that notifying the system of a particular choice, out of the various options provided by the software, is much easier a mouse than pressing various key combinations. With proper software, a mouse can also be used to draw picture on the screen and edit text.

The roller-ball based mouse is now being replaced with optical sensor based mouse. The optical sensor mouse has a light source with a sensor arranged in such a fashion that the light coming from the source is detected by the sensor after reflection from the surface. The on-board electronics on the mouse uses the reflection differences to calculate the direction and speed of movement and notifies the computer system. The optical sensor mouse is more sensitive, easier, and smoother to use. Another innovation in mouse is to have user-programmable buttons on the sides and the middle button on top is replaced with a wheel that can be rotated as scroll to scroll the screen display and can also be pressed as a button.

4.2.1.4 Data Scanning Devices

Data scanning devices are input devices used for direct data entry into a computer system from source documents. Some of them are also capable of recognizing marks or characters. These devices have following characteristics:

1. They eliminate the need for manual entry of data by human beings. Automatic entry of data with their use improves data accuracy and increases timeliness of the information processed.
2. They demand high quality of input documents because of direct data entry from source documents. Documents that are typed poorly, have strikeovers, or have erasures are normally rejected.
3. Form design, and ink specification usually becomes more critical with the use of these devices than when keyboard devices are used to key in data from forms. Data scanning devices are of many types. Commonly used ones are described below.

Image Scanner

An image scanner is an input device that translates paper documents into an electronic format that can be stored in computer. The input documents may be typed text, pictures, graphics, or even handwritten material. This input device has been found to be very useful in preserving paper documents in electronic form. A copy of a document stored in a computer in this manner will never deteriorate in quality or become yellow with age, and can be displayed or printed, whenever desired. The stored images can even be altered and manipulated in interesting ways, if the computer has image-processing-software.

Image scanners come in various shapes and sizes. Two commonly used types are:

- I. **Flatbed scanner.** A flatbed scanner is like a copier machine consisting of a box having a glass plate on its top and a lid that covers the glass plate. A document to be scanned is placed upside down on the glass plate. A light source, situated below the glass plate, moves horizontally from one end to another when activated. After scanning one line, the light beam moves up a little and scans the next line. The process is repeated for all the lines. It takes about 20 seconds to scan a document of size 21 cm x 28 cm.

Figure 4.9: A Flatbed Scanner



2. **Hand-held scanner.** A hand-held scanner has a set of light emitting diodes encased in a small case that can be held in hand conveniently (See Figure 4.10). To scan a document, the scanner is dragged slowly over it from its one end to the other end with its light on. The scanner has to be dragged very steadily and carefully, otherwise the conversion of the document into its equivalent bit map will not be correct. Due to this reason, hand-held scanners are used only in cases where high accuracy is not needed. They are also used when the volume of documents to be scanned is low. They are much cheaper than flatbed scanners.

Figure 4.10: A Hand-held Scanner



Optical Character Recognition (OCR) Device

When image scanners are used for inputting text documents (typed or handwritten), they have following two limitations:

1. Since a scanned input document is stored as an image, instead of text, it is not possible to do any word processing of the document (the computer cannot interpret the stored document as letters, numbers and special characters).
2. Storage space required for storing the document as an image is much more than that required for storing the same document as a text. For example, a page of printed text having 2000 characters can be stored as 2000 bytes by using the ASCII representation. A bitmap-image representation of the same document will require 10 to 15 times more storage depending on the resolution (granularity) of grid points.

OCR technology is used to overcome these limitations. In this case, the scanner is equipped with character recognition software (called OCR software) that converts the bitmap images of characters to equivalent ASCII codes. That is, the scanner first creates the bitmap image of the document and then the OCR software translate the array of grid points into ASCII text that the computer can interpret as letters, numbers, and special characters.

Notes

OCR software is extremely complex because it is difficult to make a computer recognize an unlimited number of typefaces and fonts. Hence, these software are designed to recognize texts written using standard type fonts (called OCR fonts). Two such standard fonts are OCR-A (American standard) and OCR-B (European standard). Figure 4.11 shows, OCR-A fonts. Note that if the document contains italics or bold face letters, or fonts other than that for which the OCR software has been designed, the OCR software will not work effectively.

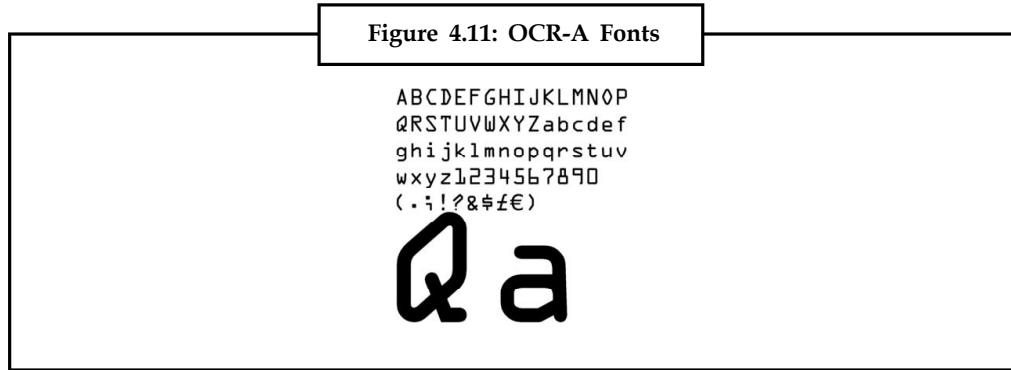

Magnetic-Ink Character Recognition (MICR)

MICR is similar to OCR. It is used by banking industry for faster processing of large volume of cheques handled every day by this industry. A bank cheque has bank's identification code (name, branch, etc.), account number, and cheque number pre-printed (encoded) on it by using characters from a special character set. A special ink containing particles of iron oxide (that can be magnetized) is used for pre-printing the characters on the cheque. Figure 4.12 shows a sample cheque that employs MICR technology.

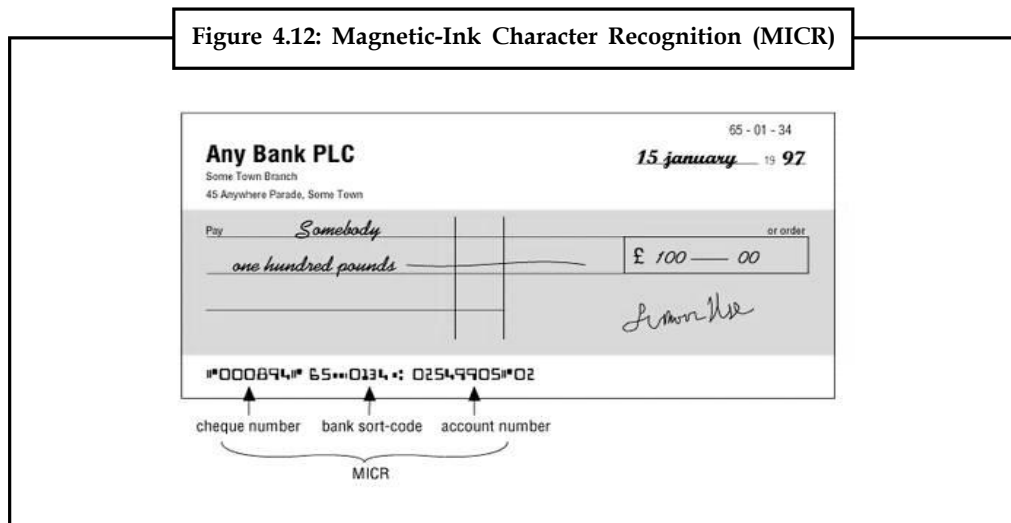

When a customer presents a filled-in cheque at a bank, a bank employee manually enters (keys in) the customer supplied information including the amount written on the cheque. This cheque is then processed by using an (MICR reader-sorter that can recognize magnetic ink characters. The MICR reader-sorter reads the pre-printed data on the cheques, and sorts the cheques for distribution to other banks or for further processing.

The most commonly used character set by MICR devices is known as E13B font consisting of numerals 0 to 9 and four special characters (See Figure 4.12). Coded data in the form of these fonts are transferred from cheques to a computer by an MICR reader-sorter. As the cheques enter the reading unit, they pass through a magnetic field causing the particles in the ink to be magnetized. Read heads then interpret these characters by examining their shapes. The sorter is used to sort the cheques into different pockets according to their identification code numbers.

Digitizer

A digitizer is an input device used for converting (digitizing) pictures, maps, and rawings into digital form for storage in computers. For example, the x and y coordinates of points in a drawing may be stored in digital form. This enables re-creation of the drawing from the stored information and easy incorporation of changes in the drawing, whenever required.

A digitizer consists of a digitizing tablet (also known as graphics tablet) associated with a stylus (See Figure 4.13). The digitizing tablet is a flat surface that contains hundreds of fine copper wires forming a grid. Each copper wire receives electric pulses. The digitizing tablet can be spread over a working table and is connected to a computer. The stylus is like a pen or a lens-like cursor with a cross hair and button. It is connected to the tablet and can be pressed down at a point on the tablet to input the (x, y) coordinates of the point. On moving the stylus on the tablet, a cursor on computer's screen moves simultaneously to a corresponding position on the screen to provide visual feedback to the operator. This enables the operator to draw sketches directly or to input sketched drawings very easily. Inputting drawings or developing sketches by using a digitizer is further simplified by the fact that poorly sketched lines, arcs, and other graphical objects are automatically input as mathematically precise objects like straight lines and smooth curves.

Digitizers are used commonly in the area of Computer Aided Design (CAD) by architects and engineers to design cars, buildings, medical devices, robots, mechanical parts, etc. They are also used in the area of Geographical Information System (GIS) for digitizing of maps available in paper form.

Figure 4.13: Digitizer



4.2.2 Output Devices

An output device is an electromechanical device that accepts data from a computer and translates them into a form suitable for use by outside world (users). Several output devices are available today. They can be broadly classified into following categories:

1. Monitors
4. Screen image projector

Notes

- 2. Printers
- 3. plotters
- 5. Voice response system

These types of output devices along with their applications are described in next page.

Output devices generate computer output that can be broadly classified into following two types:

- 1. **Soft-copy output.** A soft-copy output is not produced on a paper or some material that can be touched and carried for being shown to others. They are temporary in nature. For example, content displayed on a terminal screen, or words spoken out by a voice response system are soft-copy output.
- 2. **Hard-copy output.** A hard-copy output is produced on a paper or some material that can be touched and carried for being shown to others. They are permanent in nature and can be kept in paper files or can be looked later when the person is not using a computer. For example, output produced on paper by printers or plotters are hard-copy output.

4.2.2.1 Monitors

Monitors are the most popular output devices used today for producing soft-copy output. They display the generated output on a television like screen. A monitor is associated usually with a keyboard and together they form a *video display terminal (VDT)*. A VDT (often referred to as just *terminal*) is the most popular input/output (I/O) device used with today's computers. It serves as both an input and output device. The keyboard is used for input to a computer and the monitor is used to display the output from the computer. The name "terminal" comes from the fact that a terminal is at the terminus or end of a communication path.

Two basic types of monitors used today are *cathode-ray-tube (CRT)* and *LCD (Liquid Crystal Display) flat-panel*. CRT monitors work much like a television screen and are used with non-portable computer systems. On the other hand, LCD flat-panel monitors are thinner, lighter, and are used commonly with portable computer systems like notebook computers. With gradual reduction in price of LCD flat panel monitors, they are used increasingly with non-portable desktop computer systems also. They are also preferred because they occupy less table space.

Figure 4.14: A Video Display Terminal Consists of a Monitor and a Keyboard

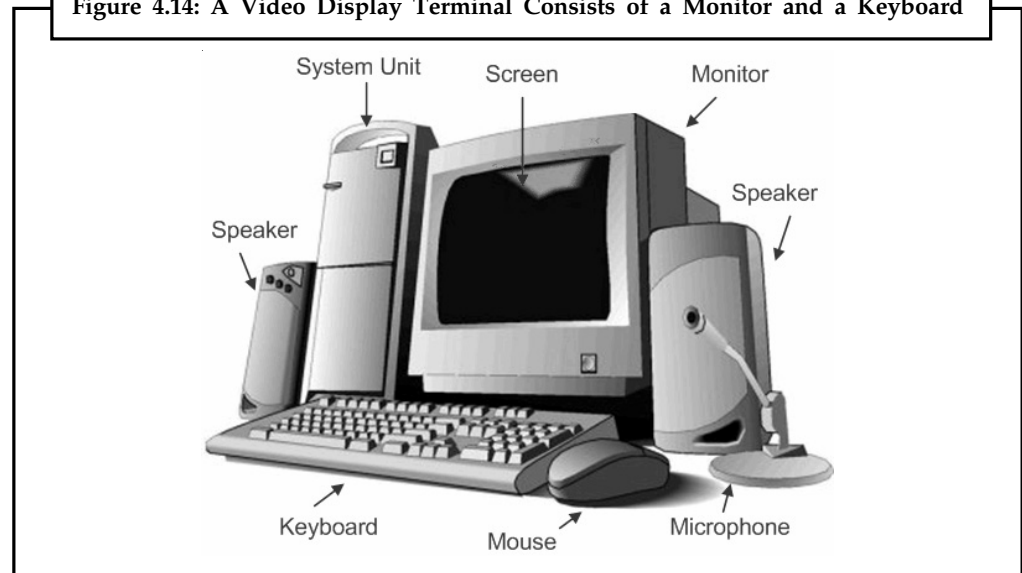

4.2.2.2 LCD Monitor

Notes

LCD stands for *Liquid Crystal Display*, referring to the technology behind these popular flat panel monitors. An LCD monitor is distinguishable from a traditional CRT monitor as the latter has a bulky footprint with a depth of several inches and a weight 13-23 kilograms or more, while LCDs are commonly 1-3 inches (2.5-7.5 cm) thick and weigh less than 4.5 k.

LCD displays were used on laptop computers before the technology improved enough to make the jump to desktop monitors. An LCD monitor consists of five layers: a backlight, a sheet of polarized glass, a “mask” of colored pixels, a layer of liquid crystal solution responsive to a wired grid of x, y coordinates, and a second polarized sheet of glass. By manipulating the orientations of crystals through precise electrical charges of varying degrees and voltages, the crystals act like tiny shutters, opening or closing in response to the stimulus, thereby allowing degrees of light that have passed through specific colored pixels to illuminate the screen, creating a picture.

Figure 4.15: LCD Monitor



4.2.2.3 Printers

Printers are the most popular output devices used today for producing hard-copy output. Different types of printers are described below.

Dot-Matrix Printers

Dot-matrix printers are character printers that print one character at a time. They form characters and all kinds of images as patterns of dots. Figure 4.16 shows how various types of characters can be formed as patterns of dots. A Dot matrix printer has a print head that moves horizontally (left to right and right to left) across the paper. Print contains an array of pins that can be activated independent of each other to extend and strike against an inked -n to form patterns of dots on the paper. To print a character, the printer activates the appropriate set of pins as the print head moves horizontally. For faster printing, many dot-matrix printers print both ways—while the printer head moves from left to right and while it moves from right to left, on return. Such method is called bidirectional printing. Figure 4.16 shows a dot-matrix printer.

Notes

Figure 4.16: A Dot-matrix Printer

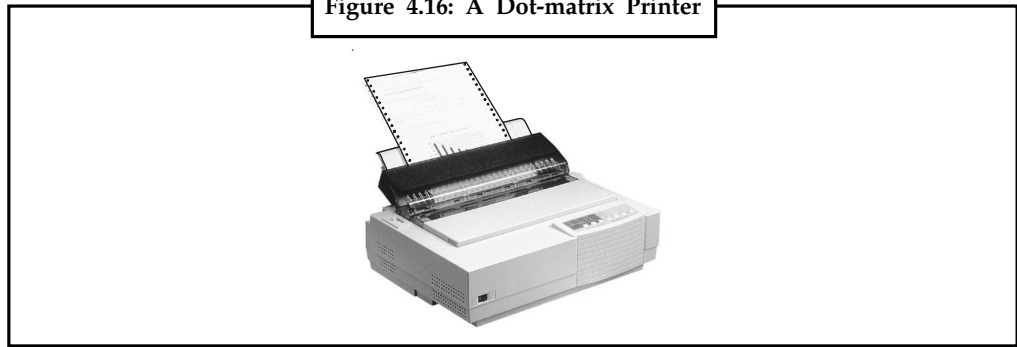
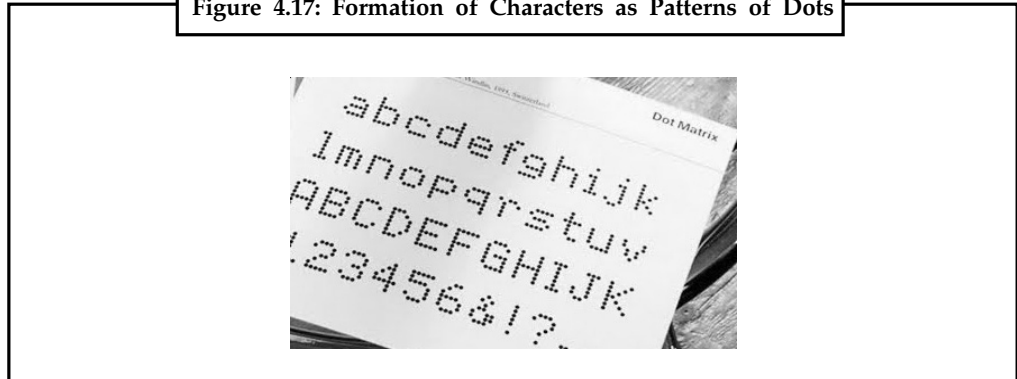

Figure 4.17: Formation of Characters as Patterns of Dots



Since dot matrix printers produce printed output as patterns of dots, they can print any shape of character that a gram can describe. They, therefore, can print many special characters, different sizes of print, and also have the ability to print graphics such as charts and graphs.

Dot-matrix printers are impact printers because they print by hammering the pins on the inked ribbon to leave ink impressions on a paper. Hence, they can be used to produce multiple copies by using carbon paper or its equivalent. Due to impact printing, dot-matrix printers are noisy as compared to non-impact printers.

Dot-matrix printers are normally slow with printing speeds ranging from 30 to 600 characters per second. However, they are cheap in terms of both initial cost and cost of operation. Hence, they are preferred by individuals and organizations for generating printed outputs if the speed and quality of printing are not important factors. They are also used for applications requiring multi-copy output such as shipping forms and invoice that on impact printing for generating multiple copies.

Inkjet Printers

Inkjet printers are character printers that form characters and all kinds of images by spraying small drops of ink on paper. The print head of an inkjet printer contains up to 64 tiny nozzles that can be heated up selectively in a few microseconds by an integrated circuit resistor. When the resistor heats up, the ink near it vaporizes and is ejected Through the nozzle making a dot on the paper placed in front of the print head. To print a character, the printer selectively heats the appropriate set of nozzles as the print head moves horizontally. Figure 4.18 shows an inkjet printer.

Figure 4.18: An Inkjet Printer



Notes

Inkjet printers produce higher quality output than dot-matrix printers do because they form characters by very tiny ink dots. A high-resolution inkjet printer has as many as 64 nozzles within a height of 7mm providing print resolution of around 360 dots per inch.

Since inkjet printers produce printed output as patterns of tiny dots, they can print any shape of characters that a program can describe. This allows the printer to print many special characters, different sizes of print, and the ability to print graphics such as charts and graphs. Inkjet printers are non-impact printers because they print by spraying ink on the paper. Hence, they are quieter in operation. Being of non-impact type, they cannot be used to produce multiple copies of a document in a single printing. A color inkjet printer usually comes with two ink cartridges—black and tri-color. The tri-color cartridge contains red, blue, and yellow colors in a package that can mix appropriate amount of these colors with black from the other cartridge to get any desired color with saturation. This makes it possible to get multi-colored and photo quality output from inkjet printers.

Inkjet printers are slower than dot-matrix printers are with printing speeds ranging from 40 to 300 characters per second. Typically, an inkjet printer is more expensive than a dot-matrix printer. They are preferred if speed of printing is not an important factor.

Drum Printers

Drum printers are line printers that print an entire line at a time. Recall that dot matrix and inkjet printers print one character at a time. Figure 4.19 shows the print mechanism of a drum printer. It consists of a solid cylindrical drum with characters embossed (raised characters) on its surface in the form of circular bands. Each band consists of all the printing characters supported by the printer in its character set. Total number of bands is equal to the maximum number of characters (print positions) that can be printed on a line. Hence, a drum printer with 132 characters per line and supporting a character set of 96 characters will have altogether 12,672 (132×96) characters embossed on its surface.

In addition to the drum, the printer has a set of hammers (one opposite each band) mounted in front of the drum in a manner that an inked ribbon and paper can be placed between the hammers and the drum. The total number of hammers is equal to the total number of bands on the drum, which is also equal to the total print positions per line.

Notes

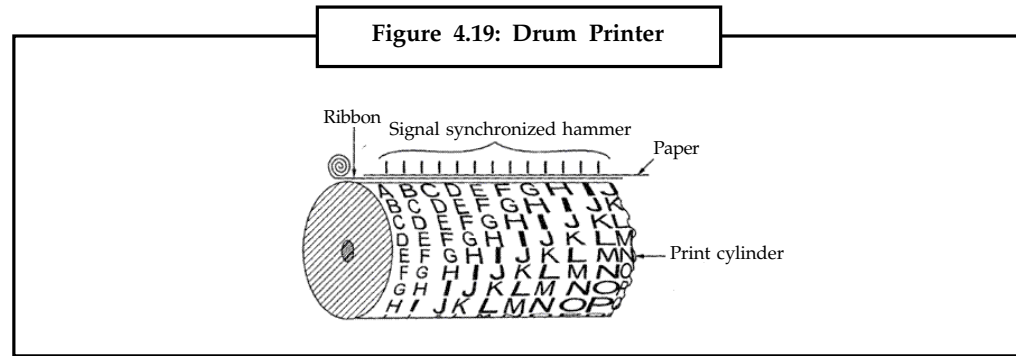

The drum rotates at a high speed. A character is printed at a desired print position by activating the appropriate hammer when the character embossed on the band at the print position passes below it. Hence, the drum would have to complete one full revolution to print each line of output. This means that not all characters on a line are printed at exactly the same time, but the time required to print an entire line is so fast that it appears as if one line is printed at a time.

The drum of a drum printer is expensive and cannot be changed often. Hence, drum printers can print a pre-defined set of characters only in a pre-defined style embossed on the drum. Drum printers, therefore, do not have ability to print any shape of characters, different sizes of print, and graphics such as charts and graphs.

Drum printers are impact printers because they print by hammering on a paper and inked ribbon against the characters embossed on the drum. Hence, they can be used to produce multiple copies by using carbon paper or its equivalent. Due to impact printing, drum printers are noisy in operation and often use a cover to reduce the noise level. Printing speeds of drum printers are in the range of 300 to 2000 lines per minute.

Chain/Band Printers

Chain/band printers are line printers that print one line at a time. Figure 4.20 shows the print mechanism of a chain/band printer. It consists of a metallic chain/band on which all characters of the character set supported by the printer are embossed. A standard character set may have 48, 64, or 96 characters. In order to enhance printing speed, the characters in the character set are embossed several times on the chain/band. For example, the chain/band of a 64 character set printer may have four sets of 64 characters each embossed on it. In this case, the chain/band will have altogether 256 (64 x 4) characters embossed on it. The printer has a set of hammers mounted in front of the chain/band in a manner that an inked ribbon and paper placed between the hammers and chain/band. The total number of hammers is equal to the total number of print positions. Therefore, a printer supporting 132 print positions will have 132 hammers. The chain/band rotates at a high speed. A character is printed at a desired print position by activating the appropriate hammer when the character embossed on the chain/band passes below it. Since the character set is repeated several times on the chain/band, it is not necessary to wait for the chain/band to make a complete revolution to position the desired character in the correct print position.

Unlike the drum of a drum printer, the chain/band of a chain/band printer can be changed easily. This allows use of different fonts (styles of characters) and different scripts (languages) to be used with the same printer. Like drum printers, chain/band printers can print only pre-defined sets of characters embossed on the chain/band used with the printer. Chain/

band printers, therefore, do not have the ability to print any shape of characters, different sizes of print, and graphics such as charts and graphs.

Notes

Figure 4.20: Printing Mechanism of a Chain/Band Printer

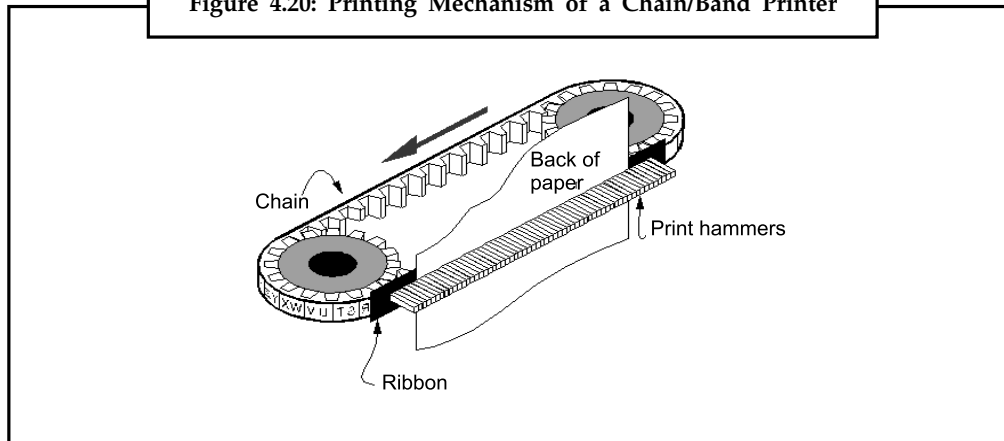

Chain/band printers are impact printers because they print by hammering on a paper and inked ribbon against the characters embossed on the chain/band. Hence, they can be used to produce multiple copies by using carbon paper or its equivalent. Due to impact printing, chain/band printers are noisy in operation and often use a cover to reduce the noise level. Printing speeds of chain/band printers are in the range of 400 to 3000 lines per minute.

Laser Printers

Laser printers are page printers that print one page at a time. Main components of a laser printer are a laser beam source, a multi-sided mirror, a photoconductive drum, and toner (tiny particles of oppositely charged ink). To print a page of output, the laser beam is focused on the electro statically charged drum by the spinning multi-sided mirror. The mirror focuses the laser beam on the surface of the drum in a manner to create the patterns of characters/images to be printed on the page. Since the drum is photoconductive, a difference in electric charge is created on those parts of the drum surface that are exposed to the laser beam. As a result, the toner, composed of oppositely charged ink particles, sticks to the drum in the places where the laser beam has charged the drum's surface. The toner is then fused permanently on. The paper with heat and pressure to generate the printed output. The drum is then rotated and cleaned with a rubber blade to remove the toner sticking to its surface to prepare the drum for next page printing. Figure 4.21 shows a laser printer.

Figure 4.21: A Laser Printer



Notes

Laser printers produce very high quality output because they form characters by very tiny ink particles. The most common laser printers have resolution of 600 dpi (dots per inch), whereas some high-end laser printers have resolution of 1200 dpi. Due to their high resolution, these printers give excellent graphics art quality.

Since laser printers produce printed output as patterns generated by the laser beam, they can print any shape of characters that a program can describe. They, therefore, can print many special characters, different sizes of print, : also have the ability to print graphics such as charts and graphs.

Laser printers are non-impact printers. Hence, they are very quiet in operation. Being of non-impact type, they can not be used to produce multiple copies of a document in a single printing.

Although most laser printers can print in black color only because they have a single toner-drum arrangement, now even color laser printers are available at affordable price. A color laser printer like color inkjet printer four color toners, each with a drum of its own. The usage of drums and toners are same as earlier, but drum is charged in such a way that together they produce the desired color output.

Laser printers are faster in printing speed than other printers discussed earlier. Low speed laser printers can print 4 = pages per minute. High-speed laser printers are also available. Owing to their better print quality and printing speed, laser printers are more expensive than other types of printers.

4.2.2.4 Plotters

We learnt earlier that dot matrix, inkjet, and laser printers are capable of producing graphics output. However, engineering design applications like architectural plan of a building, design of mechanical components of an air craft or a car etc., often require high-quality, perfectly-proportioned graphic output on large sheets. The various: types of printers discussed above are not suitable for meeting this output requirement of such applications. A special type of output device, called *plotters*, is used for this purpose. Plotters are an ideal output device for architects, engineers, city planners, and others who need to routinely generate high-precision, hard-copy, graphic output of widely varying sizes. Two commonly used types of plotters are drum plotter and flatbed plotter. They are described below:

Drum Plotter

In a drum plotter, the paper on which the design is to be made is placed over a drum that can rotate in both clockwise and anti-clockwise directions to produce vertical motion. The mechanism also consists of one or more penholder mounted perpendicular to the drum's surface. The pen(s) clamped in the holder(s) can move left to or right to left to produce horizontal motion. A graph-plotting program controls the movements of the drum and pen(s) that is, under computer control, the drum and pen(s) move simultaneously to draw designs and graphs; sheet placed on the drum. The plotter can also annotate the designs and graphs so drawn by using the pen to draw characters of various sizes. Since each pen is program selectable, pens having ink of different colors can be mounted in different holders to produce multi-colored designs. Figure 4.22 shows a drum plotter.

Notes

Figure 4.22: A Drum Plotter

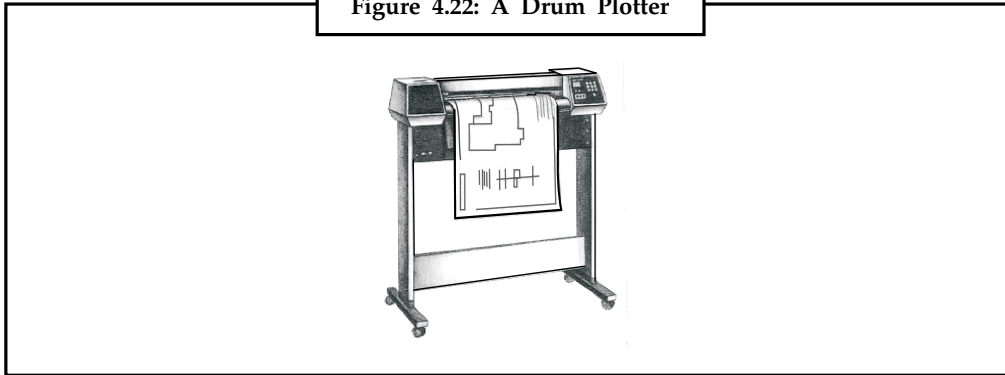
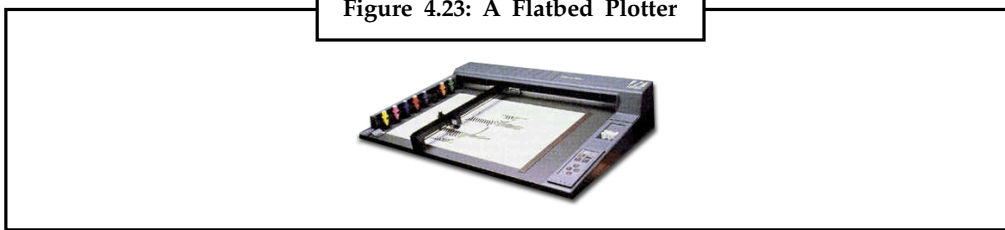

Figure 4.23: A Flatbed Plotter



4.3 Latest Input Devices in Market

1. Keyboard
2. Pointing Devices
 - (a) Mouse
 - (i) Mechanical mouse
 - (ii) Optical mouse
 - (b) Track Ball
 - (c) Joystick
 - (d) Touch Screen
 - (e) Light Pen
 - (f) Touch Pad
4. Digital Camera
5. Scanner
6. Microphone
7. Graphic Digitizer
8. Optical Scanners
9. Optical Character Recognition (OCR)
10. Optical Mark Recognition (OMR)

Notes

- 11. Magnetic-Ink Character Recognition (MICR)
- 12 Bar Code Reader (BCR)



In current market there are many local devices are available so never take local devices.

4.4 Latest Output Devices in Market

- 1. Monitor
- 2. Compact Disk
- 3. Printers
- 4. Speaker
- 5. Disk Drives
- 7. Floppy Disk
- 8. Headphone
- 9. Projector



Case Study

Journey of the Evolution of Secondary Storage

Do you remember the last time you used the FDD drive of your computer, and for what? Chance is if you have used it then it would be for some emergency booting of the computer, or for recovery of your broken OS. In summary, you would have not used it as a data transfer or storage medium.

Currently this magnetic medium is fast getting replaced by the Flash Rom drives that we also know by Pen Drive or USB Drive. This new medium is killing the old magnetic medium for its reliability, speed and ever growing capacity.

Historically the secondary storage is always in the realm of change. Technology and needs are always pushing the medium smaller, faster, more reliable, secure and of expanding capacity. Just like some 10 years back the 5.25" drives were replaced by this 3.5" drives for smaller size and larger capacity.

History

History of secondary storage is quiet interesting, as it has seen the use of papers to silicon to optical medium. With each generation it gets better, faster and smaller is size and always increasing the storage capacity.

Paper Punch Card

Paper Punch cards used initially as the first external storage device. It used paper card/roll with holes as data. Meaning a hole was zero, and no hole was one. Programmers

Contd...

used to punch the card for even providing input. Printers were there to punch the output for storage.

Floppy Drive (8")

Once the magnetic media started to be used for storage, paper was quickly made obsolete. Magnetic disks of round shape emerged as the standard for secondary storage device. It became very popular as it was more robust and handy than the paper roll, and could store more data as was relatively sturdy.

Floppy Drive (5.25")

Further advancement in the material and magnetic domain provided better density and provided much higher storage capacity in smaller area. Now the disks also started to become double sided providing even more data storage area in the same size disks.

Floppy Drive (3.5")

This media peaked with the 3.5" FDD that is small and sturdy enough to carry in the jeans pocket. This case also provided cover even for the area that is used for reading. This resulted in more protection from dust etc even if the floppy is not in any cover.

Zip Drive

This drive released in 1994 by a company called Iomega was capable of holding 100MB of data. This also uses the magnetic coating like the other FDD, but of higher quality and of superior technology that needs specialized drives for reading and writing on this media. This made is a good backup drive (like tape drives), but not good for using it on any machine. Currently the Zip Disk can hold 250MB of data.

Flash Drive (USB Drive)

Also known as Pen Drive is the next revolution in secondary portable storage device. Starting with couple of MB storage capacity the main attraction was its solid state rugged construction and capable of being used on any computer equipped with USB port. Initially it needed specific driver to be installed on the earlier OS in order to it getting recognized, but later, due to its universally standard and open protocol and rise in use of USB port in computers, its support was provided along with the OS. (Windows/Macintosh/Linux also support this natively out of the box).

So now virtually nothing more is needed for this drive to work if you have a computer with USB port. Though the manufacturers are also providing additional features to the hardware drive like security to the data stored on it using encryption, but these features generally require additional software/driver to be installed in order to be used. And since there is not much standard for these features it is mostly device specific and is largely ignored for its lack of compatibility.

This standardization of protocol has lead to not only popularity of the USB flash drives, but has also provided a common way for other media to act as drive via this protocol. So now there are storage products making use of this standard to become USB drives (also called USB Mass Storage). Example includes USB Hard Disk Drives, Zip Drive with USB interface, digital camera having a USB cable to make it an USB drive for accessing all the photographs clicked, even PDAs like Palm that already connect to the computer using USB port acts as a USB drive for accessing the data in its memory and SD/MMC Card present or the Mp3 player that doubles as USB drive!! The list and applications are

Contd...

Notes

getting bigger and bigger, ultimately making this drive a very popular and successful.

Currently 1 GB USB flash drives are available, and bigger drives are on the horizon. (Interestingly HDD popular as of now is of 160GB and more).

Card Media (SD/MMC/MS)

It is that stamp sized media that became popular from portable devices like Cameras and Phones. Media started shrinking and its capacity always increasing. One can locate a 8 GB Micro SD Card at a reasonable price these days. It uses the same technology as the USB Drive internally, only the interface is differing in order for it to be used by various devices like Camera and Mobile Phones. Now days Card Reader for these type of media are getting shipped as a standard accessory from leading Computer manufacturers.

Portable USB HDD

As mentioned above this is also getting popular and is popular mainly for higher speed and capacity than what is currently provided by the USB flash drive. On the flip side it is still fragile (as having moving element) and bulkier than the flash drive.

Solid State Disk (SSD) having USB Interface

This is a semiconductor (like flash memory) based persistent data storage device that is having no moving parts inside, hence Solid State Disk. It emulates a Hard Disk Drive Interface with added bonus being more robust, faster, quieter, less space and power requirement, as compared to any hard disk drive.

These devices have started to find way into high end Laptops and Computers (like Sony Vaio TZ Series). Though costly right now, it may become a standard secondary storage medium in the coming years.

Holographic Drives

Last but not the least is the future. This is the media of the future that uses technology that is still in its infancy and is called holography. Though holography and holograms are nothing new and was discovered in late 1940s, but its application for data storage is new. A company called In Phase Technologies is one of the forerunners in this field that has prototyped disks that can hold 200GB to 1.6TB of data. This technology uses lasers for reading and writing of data.

Questions:

1. Explain the working of Paper Punch Card.
2. How to Portable USB HDD in computer?

4.5 Summary

- Secondary storage is a hard disk that save more data in computer.
- Hard disk is secondary storage services.
- Input device means that provide the input from user side in the computer.

- Output devices is used display the result of computer.
- Digitizer consists of a digitizing tablet (also know as graphics tablet) associated with a stylus.
- A potters is special type of output device that use in computer.
- Lager printer are non impact printer, they are very quiet in operation. Being of non-impact type, they can not be used to produce multiple copies of a document in a single printing.

4.6 Keywords

Terminal: A monitor is associated usually with a keyboard and together they form a Video Display Terminal (VDT). A VDT (often referred to as just terminal) is the most popular input/output (I/O) device used with today's computers.

Hot-Spot of graphics: The graphics cursor, irrespective of its size and shape, has a pixel-size point that is considered the point of reference to decide where the cursor is positioned on the screen. This point is called hot-spot of the graphics cursor.

Flush memory: Storage technology Recall that flash is non-volatile, Electrically Erasable Programmable Read Only Memory (EEPROM) chip.

Plotter: A special type of output device, called plotters, is used for this purpose. Plotters are an ideal output device for architects, engineers, city planners, and others who need to routinely generate high-precision, hard-copy, graphic output of widely varying sizes.

LCD: LCD stands for Liquid Crystal Display, referring to the technology behind these popular flat panel monitors.

Digitizer: A digitizer is an input device used for converting (digitizing) pictures, maps, and rawings into digital form forstorage in computers. For example, the x and y coordinates of points in a drawing may be stored in digital form.



Lab Exercise

1. Define output device.
2. Define all secondary storage devices.

4.7 Self-Assessment Questions

1. RAM chips plugged into special sockets on the motherboard are known as
 - (a) SIMMs
 - (b) SINNs
 - (c) SIMNs
 - (d) None of these
2. The act of retrieving data from a storage location is called
 - (a) Memory write operation
 - (b) Memory read operation
3. storage system consists of a rotating disk coated with a thin metal.
 - (a) Memory disc
 - (b) Optical disk
 - (c) Hard disk
 - (d) None of these

Notes

4. LED indicator stands for
(a) Light-emitting diode (b) Level-emitting diode
(c) Low-emitting diode (d) None of these
5. A is a pointing device similar to a roller-ball mouse.
(a) Electronic pen (b) Trackball
(c) All of above (d) None of these
6. A color inkjet printer comes with two ink cartridges-black and
(a) Tricolor (b) Blue, green, white (c) None of these
7. A4 size is equal to 8" × 12" page.
(a) True (b) False
8. CRT stands for
(a) Crystal ray tube (b) Cathode ray tube
9. The UPC bar code patterns are decoded asdigit.
(a) 5 (b) 10
(c) 12 (d) 2

4.8 Review Questions

1. What is a secondary storage? How does it differ from a primary storage?
2. What are the main limitations of primary storage of a computer system?
3. Why I/O devices are necessary for a computer system?
4. What are peripheral devices? Why are they called so?
5. Why I/O devices are very slow as compared to the speed of primary storage and CPU?
6. What is an input device? Name some commonly used input devices.
7. What are keyboard devices?
8. What are point-and-draw devices? Name some commonly used point-and-draw devices.
9. Explain how information is recorded on a magnetic tape.
10. Why is the secondary storage used in most computer \stems?
11. Name some popular secondary storage devices used in today's computer systems.
12. What is a sequential-access storage device? Write examples of a few applications for which such a storage device is suitable.
13. What is a random-access storage device? Write examples of a few applications for which such a storage device is suitable.
14. Distinguish between a sequential access, a direct access, and a random access storage device. Write one example of each.
15. What factors determine storage capacity of disks?

Answers for Self-Assessment Questions

Notes

- | | | | |
|--------|--------|--------|--------|
| 1. (a) | 2. (b) | 3. (b) | 4. (a) |
| 5. (b) | 6. (a) | 7. (b) | 8. (b) |
| 9. (b) | | | |

4.9 Further Readings



Books

Fundamental Computer Skills, Feng-Qi Lai, David R. Hofmeister.

A Study of Computer Fundamental, Shu-Jung Yi.



Online link

<http://books.google.co.in/bkshp?hl=en>

Notes

Unit 5: MS Window

CONTENTS

Objectives

Introduction

5.1 Windows Features

5.1.1 The Find Feature

5.1.2 Properties

5.1.3 Quick View

5.1.4 Right Clicking

5.2 An Overview of Different Versions of Windows

5.2.1 List of Windows Client OS with Their Version Numbers

5.3 The Desktop

5.3.1 Display

5.4 My Computer

5.4.1 How to Open My Computer

5.4.2 Using My Computer

5.4.3 Adjust System Settings with Computer

5.5 Summary

5.6 Keywords

5.7 Self-Assessment Questions

5.8 Review Questions

5.9 Further Readings

Objectives

After studying this unit, you will be able to:

- Understand the windows various features
- An overview of different properties of windows
- Discussed about the desktop and its display
- Explain the execution pattern of My Computer
- Discussed the using of My Computer, also adjuster of system sittings with computer

Introduction

Windows is a GUI (Graphical User Interface). This replaces all the old keyword command and functions with a user-friendly screen. There are different version of windows which

includes Windows 95, windows 98, windows ME, windows XP, windows Vista and windows 7. Include with the windows operating system are some useful accessories which include wordpad, note pad paint. Although these application(Programs) are very basic in their facilities, they can be used to accomplish several tasks users would like to perform a computer.

Notes

5.1 Windows Features

The hottest new features of Windows 98 are as follows:

- **Improved Setup:** Within two years of introducing Windows 95, Microsoft completely upgraded its software. Windows 98 is a completely redesigned and speedier version. Windows 98 also supports direct upgrades from Windows 3.1x. Windows 98 set up uses the information in Windows 95 to detect the utilities and hardware already installed on the computer. This helps speed the initial setup process as setup then does not have to do full hardware detection.
- **Improved Desktop:** The Windows 98 desktop includes many new enhancements, including floating toolbars that are accessible right from the taskbar. We can drag icons on to and off the Start menu. Going through Windows Explorer to manipulate Start menu options is no longer necessary. The Start menu now includes a “Favorites” category containing shortcuts to all our favorite resources and web sites. The Help facility has been improved and uses the new HTML format.
- **Integration With the Web:** Windows 98 supports Microsoft Internet Explorer 4.0 which includes Outlook Express, Microsoft NetMeeting, NetShow, and FrontPage Express. Outlook Express is a new e-mail/newsgroup client that supports POP3, HTML Mail, and NNTP (newsgroup support). NetMeeting is an Internet conferencing tool that enables Internet users to perform audio, video, and text based conferences over the Internet with other users. NetShow is Microsoft’s networked multimedia software for on-demand audio and video capabilities. FrontPage Express is a personal web page editing tool.
- **Multiple Display Support:** One of Windows 98’s new features is called “Multiple Display Support” the capability to extend our Windows 98 desktop over two or more monitors.
- **Web-Based Support Tools:** The Internet has allowed Microsoft to enable easier support in Windows 98. A new web-based utility helps reduce the cost of ownership and makes upgrading much easier by providing a simple update engine that helps update Windows 98 components and drivers easily.
- **Windows Tune-Up Wizard:** Windows Tune-Up Wizard, another utility in Windows 98, is designed to make computing easier. It enables us to schedule and run regular tune-ups of the operating system easily which will help programs run faster, free space on hard drive, and help we achieve optimal system performance.
- **Disk Cleanup:** A utility related to the Windows Tune-Up Wizard is the new Disk Cleanup tool. This new tool removes unnecessary files from a disk.
- **Task Scheduler:** Task Scheduler provides a friendly and easy-to-use interface for scheduling applications. It enables us to schedule a script, a program or a document to be run at any time or interval—from everyday to once a year—or on events such as system startup, user log on, or system idle.

Notes

- **Accessibility Improvements:** Windows 98 introduces a new Accessibility Settings Wizard. This wizard helps physically challenged people to adapt their computer's visual settings to fit their needs. One feature included in the accessibility improvements is a screen magnifier that helps visually impaired people.
- **Windows 98 Performance:** Microsoft has improved performance in many areas in Windows 98, including system boot time, application load time, system shutdown time and general system-wide performance.
- **Multimedia Enhancements:** Windows 98 includes DirectShow 2.0 and DirectX 5, both of which provide an improved gaming and multimedia infrastructure. Many new games and multimedia products will take advantage of DirectX 5 and DirectShow 2.0.
- **Broadcast Architecture and TV Viewer:** Microsoft has in this version bundled software for broadcast-enabled computers. This software blends television with web pages and computer content. It also enables us to view and use broadcast enabled computers as "receive-only" network devices. We can receive true data broadcasts of web pages, multimedia streams and data packets, such as stock quotes and news feeds. The TV Viewer enables us to watch standard TV delivered via satellite or cable.

Windows 7: Five Unique Features

Other parts of this story package are dedicated to explaining how to replicate windows 7 features on a Vista or XP machine and we offer so many suggestions that you may be starting to think that perhaps there's no compelling reason to upgrade to windows 7 after all. If so, you should think again. Though Vista and XP users can enjoy some of the new operating system's goodies, either directly or by proxy, various highly desirable features are available only in the genuine article. Here are five that will require you to roll a 7.

1. **Device Stage:** Whereas Vista barely seems to recognize the presence of cameras, phones, printers, and other external devices, windows 7's Device Stage treats them like royalty. The operating system devotes a slick-looking status window to each device, so you can browse files, manage media, and perform other device-specific tasks.
2. **Home Group:** At long last, Microsoft promises to take the pain and frustration out of home networking for users of its operating system. Set up a Home group, and then add PCs and other devices and without further ado you can shares files, printers, and the like. Why didi it take seven versions of Windows to get this right?
3. **Jump Lists:** Like souped-up Recent Documents menus, jump Lists provide quick access to application specific documents and/or tasks. For example, you can right-click the Internet Explorer taskbar icon and choose from a list of frequently visited Web sites or from a list of avaiable tasks (such as New Tab and Inprivate). Once you get started using jump lists, you will wonder how you ever got along without them.
4. **Libraries:** Most of us have documents, music, pictures, and video scattered across multiple folders on our PCs. Libraries are specials folders in Windows 7 that catalog these items under a single roof, regardless of where you actual store them on your hard drive. And best of all, Libraries are easy to share within your HomeGroup.

With Windows 7, the task of choosing a Wi-Fi network connection becomes an effortless, one-click affair.

5. **One click Wi-Fi:** Unlike windows Vista, Windows 7 makes choosing a wireless network to connect to simple and conveneient: Click the system-tray icon, and choose from the

resulting list of available hotspots. Granted, you can find third-party connection managers for Vista, but nothing this streamlined and unobtrusive.

Notes

5.1.1 The Find Feature

The Find feature can be used to locate the following:

- **Files or Folders:** it helps in finding files or folders after providing their names and location. The file can also be searched by a distinctive word or phrase it contains. Files can also be searched by their date of creation or their size.
- **Computers:** Using this we can find a particular computer on the network by providing the name of the computer.
- **On the Internet:** Any information on the Internet can be searched by providing the required information.
- **People:** Internet can be searched using this option.

5.1.2 Properties

Sometimes, it is important to have information about files, folders, and programs. For example, we might require the size and location a particular file if a certain program is not running. This information can be easily found in the property sheet. To invoke the property sheet of any item, right click its icon and choose properties from the menu that appears. The property sheet of that item will appear containing the characteristics of that item like color, size, shape, etc.

5.1.3 Quick View

Quick View is an interesting feature that enables us to take a quick peek at the contents of a file without opening a big program. It appears on the shortcut menu when an icon for a document is right clicked. Quick view only appears if it has been installed and only if the document can be viewed in that manner.

5.1.4 Right Clicking

The left mouse button opens an object but it is the right mouse button that really adds power to Windows 98. Every thing on the desktop including the desktop can be right clicked. It displays a shortcut menu of commands appropriate for the item on which the mouse is right clicked.

5.2 An Overview of Different Versions of Windows

The goal of evolution of a new version is always to make each new version a bit more powerful, easier to learn and use. Windows 98 is definitely easier to manage than Windows 95. Ostensibly it is almost identical to Windows 95 but it differs slightly in the way it operates. For example, it includes single click launching, submenu options and tool tip's text opens in a different manner, etc.

Also Windows 98 includes facilities for new forms of communications and entertainment. Thus, what makes Windows 98 desirable is:

- It is easy to learn and use.
- It works with virtually every kind of program and gizmo available today.
- It is ready to bring all the exciting new electronic communications and entertainment technologies.

Notes

5.2.1 List of Windows Client OS with Their Version Numbers

Window	Version Number
Windows 1.0	1.04
Windows 2.0	2.11
Windows 3.0	3
Windows NT 3.1	3.10.528
Windows for Workgroups 3.11	3.11
Windows NT Workstation 3.5	3.5.807
Windows NT Workstation 3.51	3.51.1057
Windows 95	4.0.950
Windows NT Workstation 4.0	4.0.1381
Windows 98	4.1.1998
Windows 98 Second Edition	4.1.2222
Windows Me	4.90.3000
Windows 2000 Professional	5.0.2195
Windows XP	5.1.2600
Windows Vista	6.0.6000
Windows 7	6.1.7600

5.3 The Desktop

The desktop is a large blank page, through which most activities take place, that is, it enables us to choose the programs that are stored on it in the form of small pictures or icons. We double-click on these icons to launch the desired programs. The desktop is always in the background even after a program is started.

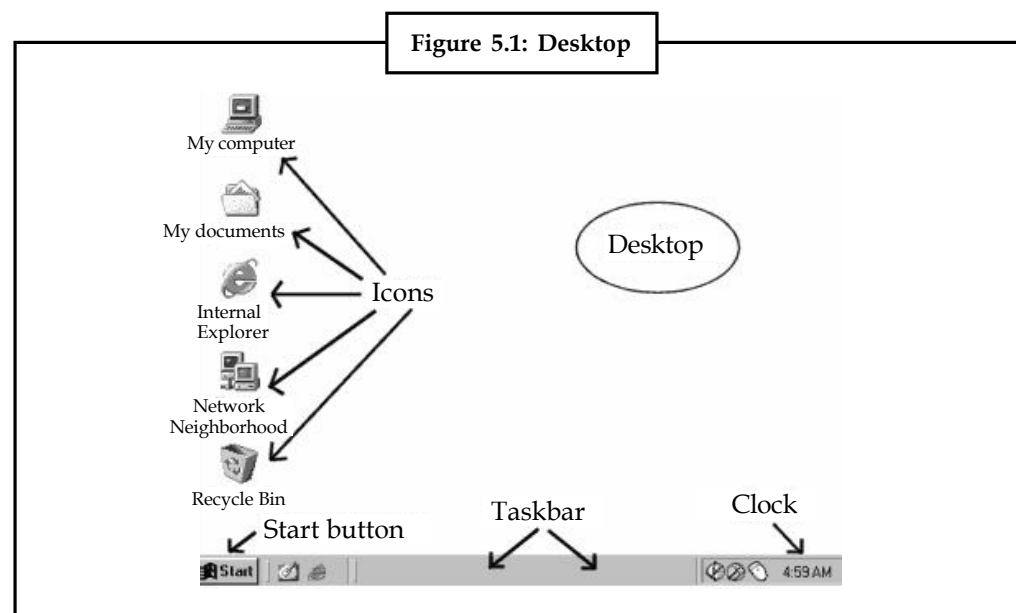

Windows 98 supports two different desktop interfaces: the “Standard Desktop” and the “Active Desktop”. The standard desktop was introduced in Windows 95. While using the standard desktop, desktop icons are activated by double clicking on them. The active desktop was introduced in Internet Explorer 4.0. It enables the desktop and other windows applications to look and act as a web page while using the active desktop, pointing the mouse pointer at an icon displays an explanation about the icon. The icons can be activated by only a single click.

Steps to enable Active desktop are:

- Right click on a blank spot on the desktop.
- Highlight the Active Desktop command.
- Choose View As Web Page.

Figure 5.2: Active Desktop

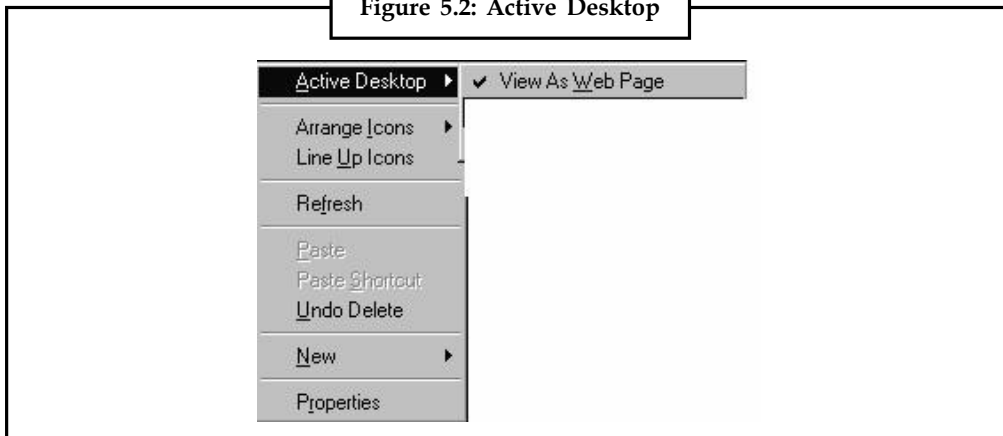

In Windows 95 the operating system automatically placed the “My Computer” icon and the “Recycle Bin” on the desktop. The icons that appeared for these items were standard—they could not be changed. But in Windows 98, the icons can be changed. The steps are:

Figure 5.3: “My Computer” icon and the “Recycle Bin” on the Desktop

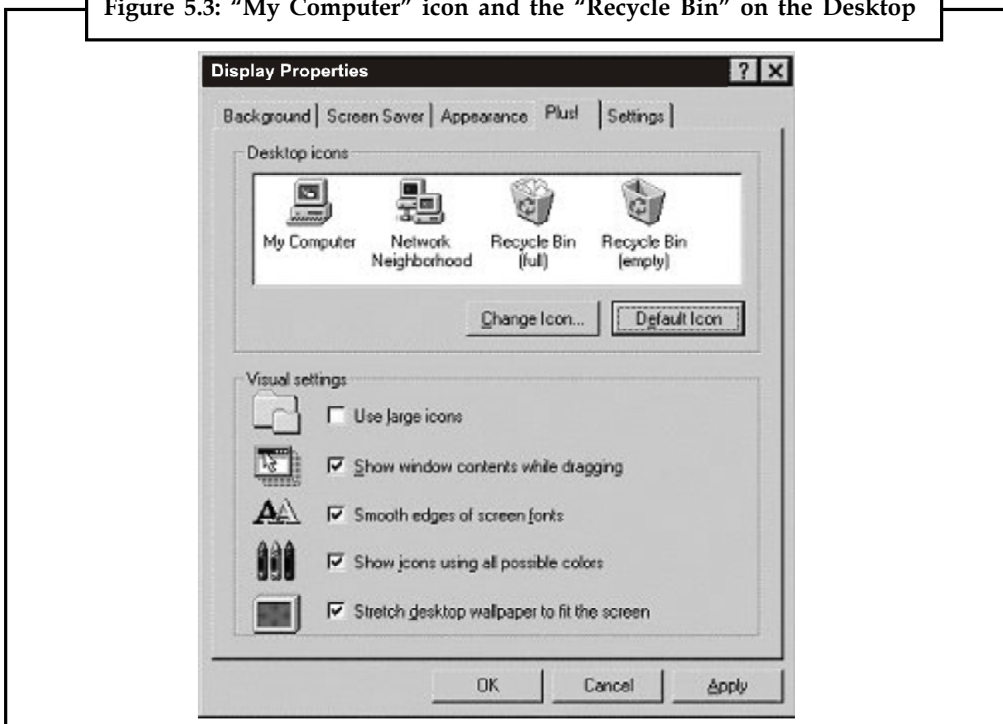

Notes

- Right click on a blank spot on the desktop and choose the “Properties” Command
- “Display Properties” dialog box will appear. Click on the “Effects” tab
- In the Desktop Icons box, click on the icon you want to change
- Then click on the “Change Icon” button. From the Change Icon dialog box, select the icon you want on your desktop
- Choose OK twice to close the dialog boxes

5.3.1 Display

The icon unravels settings that affect the screen display, including colors, screen savers, dialog boxes, and resolutions.

Figure 5.4: Desktop Properties

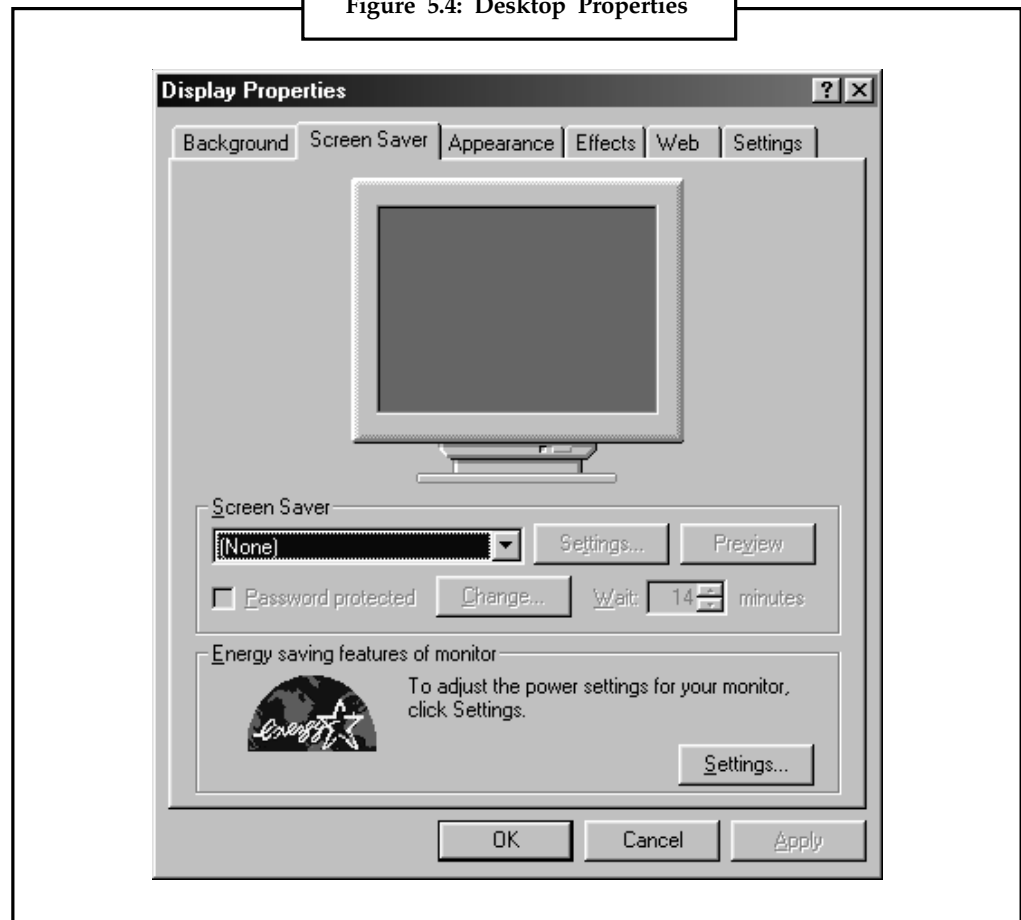

5.4 My Computer

My Computer allows the user to explore the contents of their computer drives as well as manage their computer files. Microsoft changed the traditional My Computer icon to Computer, the bottom image to the below is an example of what this icon looks like. Although the name has changed this icon still acts identical to the earlier My Computer.



5.4.1 How to Open My Computer

1. Get to the Windows Desktop.
2. Double-click the My Computer icon, this icon is almost always located on the top-left portion of the desktop and should look similar to the icon above. Below are two examples of what should appear when My Computer is open.

Figure 5.5: Drive Listing in My Computer

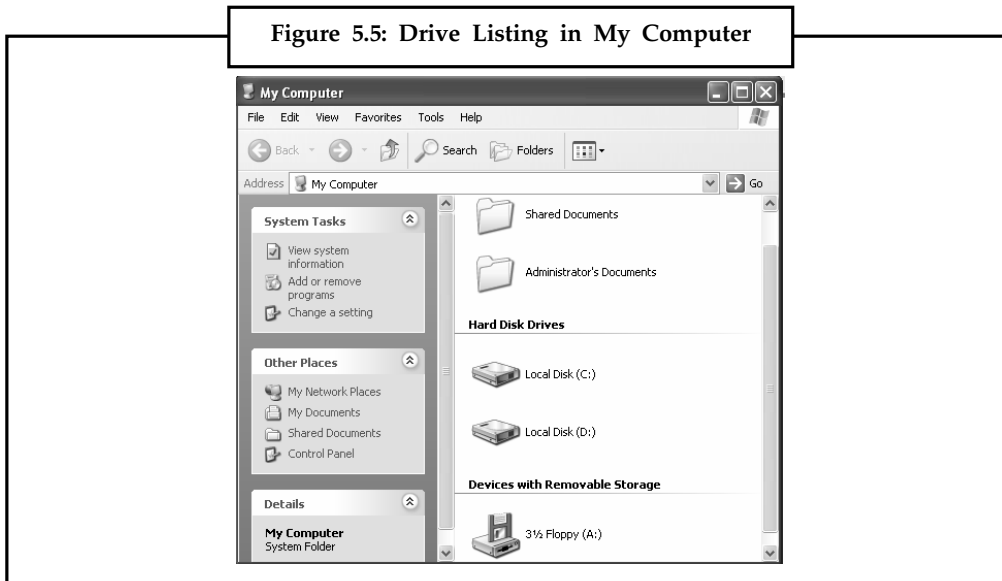
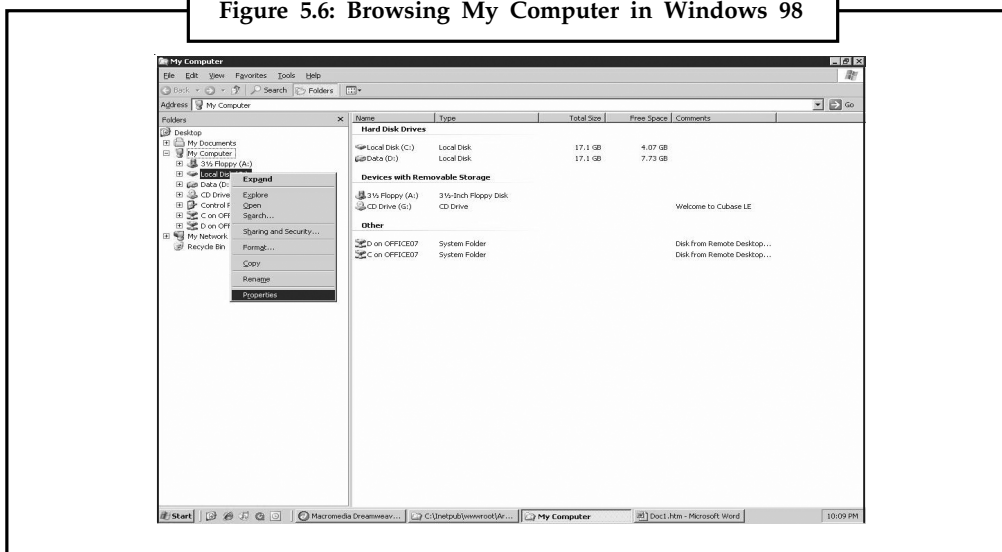

Figure 5.6: Browsing My Computer in Windows 98



Notes

5.4.2 Using My Computer

Once My Computer is open we'll see all available drives on our computer. For most users we'll only be concerned with the Local Disc (C:) drive. This is our hard disk drive and what all our files are stored on. Double-click this drive icon to open it and view of its contents.



Notes

If we're looking for a document such as a word processor file we've created, music file, picture, or other personal file it's likely that it's contained in our documents folder. This folder is displayed in My computer as a folder and usually contains your name. For example, if our username is Pradip, this folder would be named Pradip's Documents.

5.4.3 Adjust System Settings with Computer

If we wish to manage our computer or view other settings and information about our computer instead of double-clicking the My Computer icon to open it, right-click on the My Computer icon and click Properties. Performing these steps will open our System Properties (the same window accessible through the Control Panel).



Case Study

It has been 25 years since our much loved Windows Operating system came into our life, the history starts with Microsoft release of Windows 1.0 way back in 1985, and now 25 years back. Windows 1.0 was Microsoft's first GUI operating system. Since then Microsoft Windows has developed and now when we are standing with dazzling Windows 7 operating system lets look back a little from the history about the tracks which Windows OS followed.

1. **Window 1.0:** First GUI operating system form Microsoft released in the year 1985. A mix of Dos and simple graphical interface.

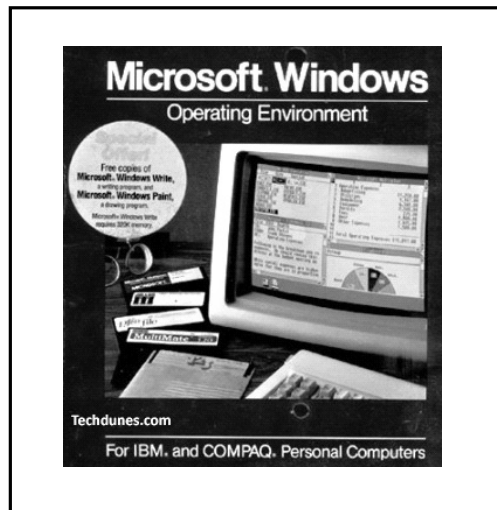

Contd...

2. **Windows 2.0:** Released on December, 1987 as a successor to Windows 1.0, Microsoft office products become capable, Like Word and Excel with this operating system.

Notes



3. **Windows 3.0:** More enhanced graphically.

Such as different features and properties of MS Window, and then different versions of Window explained in brief. Then Desktop and My computer covered which is very basic need to explain its working. Task bar, Start button, Title bar all are explained in brief, then The Control Panel covered which acts as a sort of mission control for Windows 98. It contains icons which are used to control various setting of the computer. Windows Accessories comes under which we explained multimedia and magnifier. Then at the end of the chapter file and folder searching explained.

Questions:

1. What was the purpose of development of MS Word?
2. What is Window 1.0, 2.0, 3.0?

5.5 Summary

- In this unit, we discussed about MS window and there are different versions of windows which includes windows 95, window 98, windows ME.
- Explains the features and properties of windows.
- Goal of evolution of a new version is always to make each new version a bit more powerful, easier to learn and use.
- Desktop on monitor screen is a large blank page a, through which most activities takes place.
- My computer icon on screen allows user to explore the contents of their computer drives as well as manage their computer files.

5.6 Keywords

Multiple Display Support: Multiple Display support has the capability to extend our windows 98 desktop over two or more monitors.

Disk Cleanup: A utility related to the windows Tune-up wizard is the new disk clean up tool.

Quick View: It is an interesting feature that enables us to take a quick peek at the contents of a file without opening a big program.

Notes

Active Desktop: It enables the desktop and other windows applications to look and act as a web page while using the active desktop, pointing the mouse pointer at an icon display an explanation about the icon.

Standard Desktop: It was introduced in windows 95. While using the standard desktop, desktop icons are activated by double clicking on them.

5.7 Self-Assessment Questions

1. _____ provides a friendly and easy-to-use interface for scheduling applications.
(a) Screen scheduler (b) Task scheduler
(c) Disk scheduler (d) None of these
2. One of windows 98's new features is called
(a) Multiple Display Support (b) Plug and play
(c) Mousekeys (d) All of these
3. Write the correct version number of windows NT 3.1.
(a) 3 (b) 2.11
(c) 1.04 (d) None of these
4. Net show is microsoft's networked multimedia software for on-demand audio and video capabilities.
(a) True (b) False
5. Windows 98 includes facilities for new forms of communications and entertainment. Thus, what makes
(a) It is easy to learn and use
(b) It works with virtually every kind of program and gizmo available today.
(c) It is ready to bring all the exciting new electronic communications and entertainment technologies.
(d) All of these

5.8 Review Questions

1. What is MS Windows?
2. Name any five major features of Microsoft Windows 98.
3. What are the different views available in my computers?
4. What is Desktop?
5. How do you put my computer in Standby mode?

Answers for Self-Assessment Questions

1. (b) 2. (a) 3. (d) 4. (a)
5. (d)

5.9 Further Readings

Notes



Books

A Study of Computer Fundamental, Shu-Jung Yi.
Fundamental Computer Concepts, William S. Davis.



Online link

<http://books.google.co.in/bkshp?hl=en>

Notes

Unit 6: Working with Windows Explorer

CONTENTS

Objectives

Introduction

- 6.1. Working with Windows Explorer
 - 6.1.1 Starting Explorer
 - 6.1.2 Managing Folders with Explorer
- 6.2 The Taskbar
- 6.3 The Start Button
- 6.4 The Title Bar
- 6.5 The Control Panel
 - 6.5.1 Game Controllers
 - 6.5.2 Keyboard
 - 6.5.3 Modems
 - 6.5.4 Mouse
 - 6.5.5 Telephony
 - 6.5.6 Users Accounts
 - 6.5.7 The Accessibility Option and Tools
 - 6.5.8 Font Management
 - 6.5.9 Plug and Play
 - 6.5.10 Mobile Computing
 - 6.5.11 Hot Docking and Flexible Configurations
 - 6.5.12 Power Management
- 6.6 Windows Accessories
 - 6.6.1 Multimedia
 - 6.6.2 Using the Accessibility Wizard
 - 6.6.3 Magnifier
- 6.7 Searching Files or Folders
- 6.8 Summary
- 6.9 Keywords
- 6.10 Self-Assessment Questions
- 6.11 Review Questions
- 6.12 Further Readings

Objectives

Notes

After studying this unit, you will be able to:

- Understanding of windows explorer in computer
- Discussion of task bar and start button
- Understanding and using process of title bar and control panel
- Discussion of windows accessories and its use
- Explain of and use of searching files and folders

Introduction

Windows Explorer is essentially the graphical interface that makes Windows computers easy to use. For example, the desktop and taskbar containing icons are part of the graphic interface. In fact, When the desktop or taskbar go missing, restoring them is often a simple matter of restarting the explore. exe process. Where Internet Explorer allows you to browse the Web, Windows Explorer allows you to browse Windows without having to type in DOS-like commands.

While Windows Explorer provides the overall user interface, another smaller component of it is also called Windows Explorer. This smaller component is Windows Explorer's file manager. It allows you to explore your computer's hard drive and file system. You can launch Windows Explorer in several ways including:

- Click Start > My computer (or Computer)
- Right-click Start > Explorer (or Open Windows Explorer)

6.1 Working with Windows Explorer

Windows Explorer is a folder/file-management program used to:

- View and change the folder/file structure of disks.
- View and change the contents of folders and files.
- Move, copy, rename, create, and delete folders and files.
- Start programs and open documents.
- Find folders and files.
- View and change the properties of folders and files.

Figure 6.1: Windows Explorer Screen

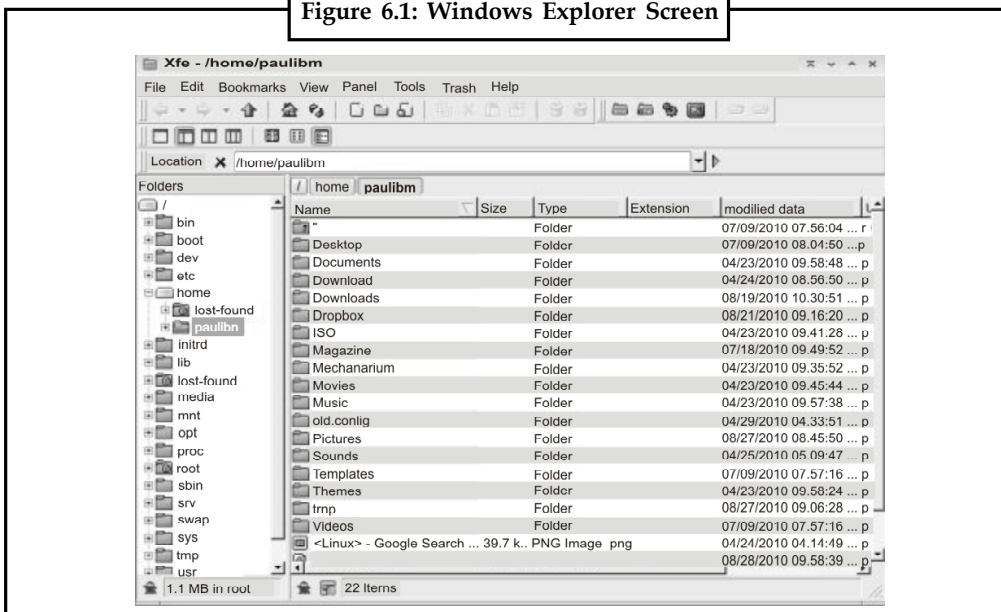

Notes

6.1.1 Starting Explorer

To start Explorer click on the Start button to open the Start menu, point to Program to open the program submenu, and click on the Explorer program icon.

A typical Windows Explorer screen is as shown in below:

The tree pane (on the left) displays the folder tree—the branching structure of the Computer’s drives and folders. The contents pane (on the right) displays the folders and files that are contained in the drive or folder selected in the Tree pane.

6.1.2 Managing Folders with Explorer

6.1.2.1 Selecting Folders

In the Tree pane, display the folder. To do this:

- Expand the disk drive on which the folder is stored.
- Expand the folder’s parent folders until the folder is displayed.
- Click on the folder.

6.1.2.2 Moving and Copying Folders

TO move or copy a folder, right-drag it from the Tree pane to the desired destination in the Contents pane. Both the source folder and destination folder must be displayed on screen at the same time.

- Move or copy a folder:
- Display the source folder in the Tree pane. A hidden folder can not be right-dragged.
- Select the destination in the Tree pane so that its contents are shown in the Contents folder.
- Right-drag the source folder (from the Tree pane) to a blank area of destination (in the Content pane) when the right mouse button is released, a shortcut menu appears, left-click on move here (to move the folder) or Copy Here (to copy the folder).

6.2 The Taskbar

The taskbar appears, by default, at the bottom of the screen. It contains a button for each open window on the desktop. The active window that appears in a lighter shade of gray. Many windows can be opened at a time on the desktop. Windows very often overlap or completely cover one another. The taskbar is used to bring any open window from hiding simply by clicking its taskbar button.

Sizing and positioning the taskbar involves the following steps:

- Taskbar can be placed along any edge of the screen.
- To move the taskbar, point to an empty area of the taskbar then drag the taskbar to some other edge of the screen.
- To size the taskbar, rest the mouse pointer right on the top of the taskbar so

Figure 6.2: The Taskbar

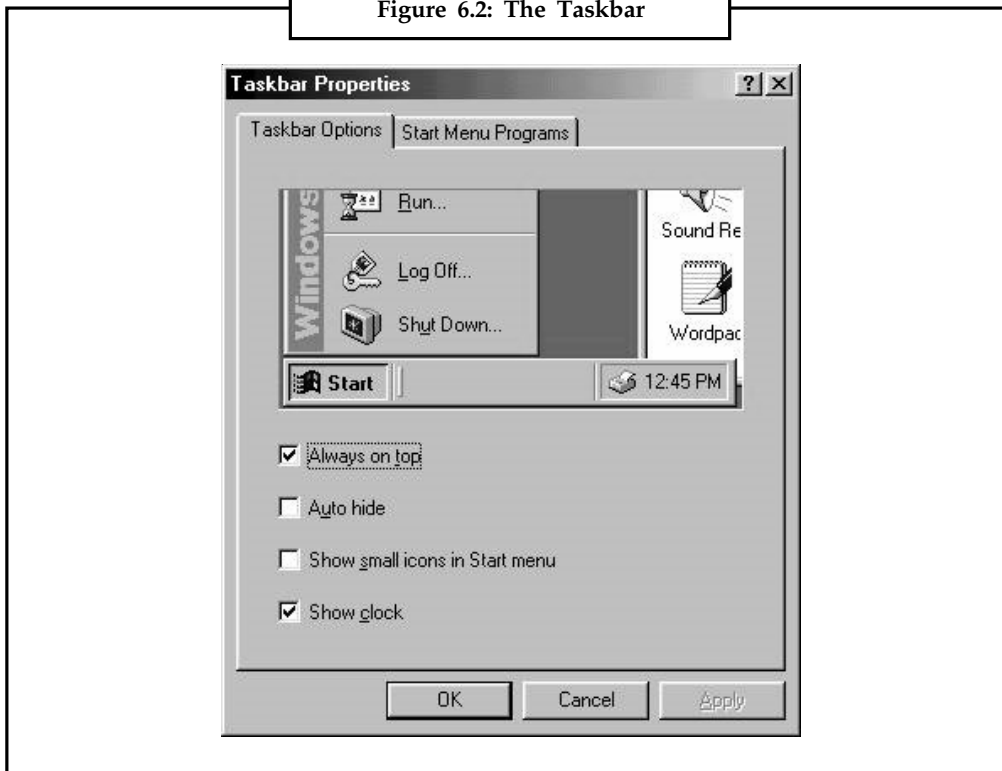

- That the mouse pointer turns into a two-headed arrow.
- Then drag the edge of the taskbar towards the centre of the screen to enlarge it or towards the closest edge of the screen to narrow it.

To hide the taskbar:

- Right click an empty part of the taskbar and then choose Properties.
- Click the Taskbar Options tab, a “Taskbar Properties” box appears.
- Select or clear “Always on top”. If this option is selected open windows never cover the taskbar, if the option is cleared, open windows may cover the taskbar.
- Select or clear “Auto hide”. If we select Auto hide, the taskbar shrinks to a thin line along the edge of the screen when it is not in use. If this option is cleared, the taskbar never shrinks to a thin line.
- Choose OK.

Windows 98 also offers four special toolbars which can be accessed via the taskbar. These are:

Address	It displays an Address box in which we can type Internet addresses or the names of disk drives, folders and files. After pressing the Enter key, the control will be passed to that place.
Links	It displays shortcut buttons to visit handy places on the Internet. Click a button to visit that place.
Desktop	It displays a button for each item on desktop.
Quick Launch	It provides easy access to favorite programs.

Notes

To turn any of these toolbars on or off

- Right click some neutral area of the taskbar and point to toolbars.
- To display or hide a toolbar, click its name. (Checked toolbars are already on display).
- To move a toolbar out of the taskbar and onto the desktop, point to the vertical bar at the left edge of the toolbar, and then drag this toolbar out.

6.3 The Start Button

The Start button appears in the lower left corner of the screen. On clicking this button, the Start menu appears.

The Start menu contains the following choices:

- Windows Update** It checks the Internet for updates to the operating system.
- Programs** It lists programs which are installed on the computer.
- Favorites** It lists web pages which are designated as favorites while surfing the Internet.
- Documents** It lists documents which were recently opened.
- Settings** It lists options which can be used to change the settings of the operating system.

Figure 6.3: Start Button

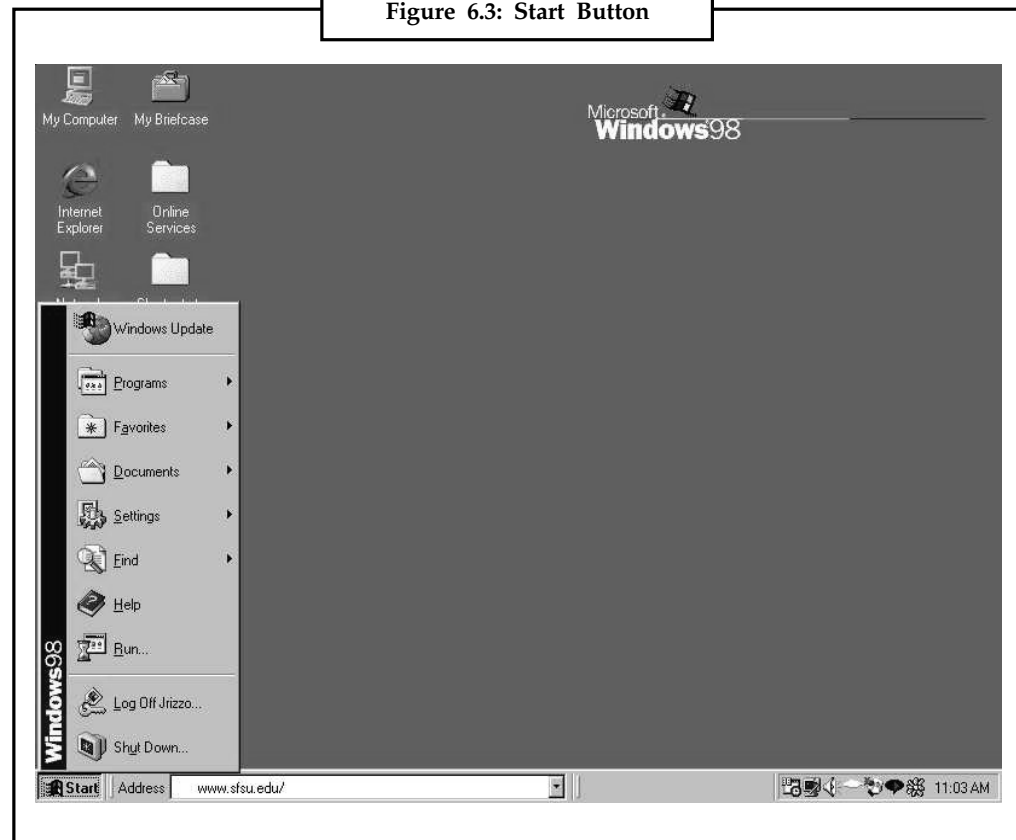

Find	Helps to search for files or folders stored in the computer.	Notes
Help	It provides help on the operating system.	
Run	It enables us to run programs for which the executable filenames are known.	
Log Off	It enables users who share a computer to log off but leave the computer running so that someone else can log on.	
Shut Down	It enables us to shut down the computer correctly, restart or restart it in MS-DOS mode.	

6.4 The Title Bar

All windows have a title bar. It is a long narrow box that stretches across the top of a window. The title bar shows the system menu icon, the title of the window or name of the program being run and the buttons to resize and close the window. When a window is active or currently being used, the title bar is highlighted, meaning that its color is different from the color of other open windows. The title bar offers handy features given below:

- To expand a window to full screen size or to shrink it back to its original size, double click its title bar.
- To move a window from a location to other new location on the screen drag the window by its title bar.

For minimizing, maximizing or closing the window, the buttons on the right side of the title bar can be used. The system menu icon on the left of title bar represents the “Program Control” menu. It is an alternate way to maximize, minimize, restore, move, resize or close a window.

Figure 6.4: The Title Bar



6.5 The Control Panel

Figure 6.5: The Control Panel

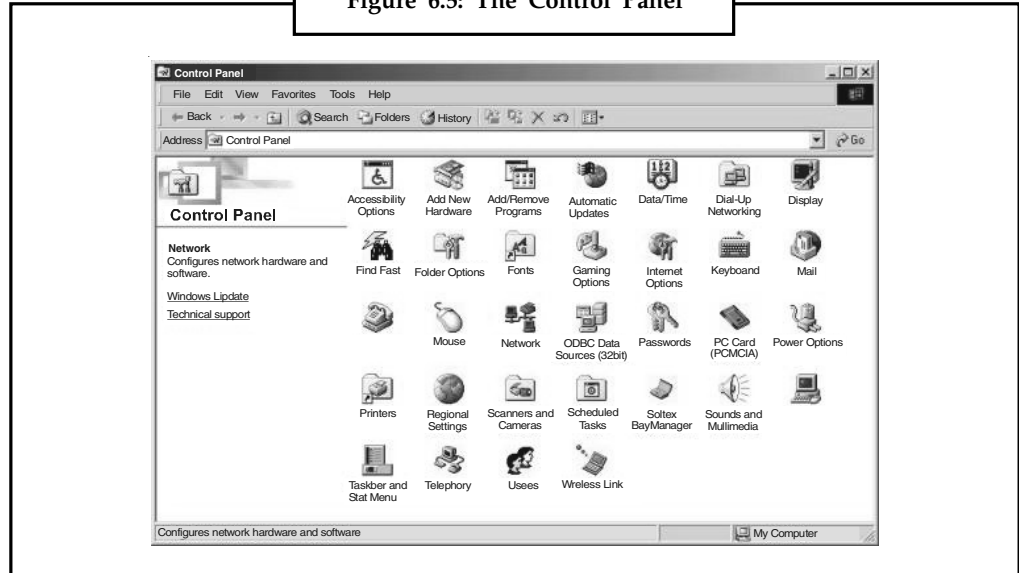

The Control Panel acts as a sort of mission control for Windows 98. It contains icons which are used to control various settings of the computer. Some of the settings behind the icon can be reached from other directions but some can be reached only by the Control Panel. To open the Control Panel, click Start >> Settings >> Control Panel.

The icons in the Control Panel differ from computer to computer because these represent software's and hardware and each computer has different hardware and software installed. Generally the following icons are displayed in the Control Panel.

6.5.1 Game Controllers

This icon can be used to add, remove or change settings for game controllers.

Figure 6.6: Game Controllers

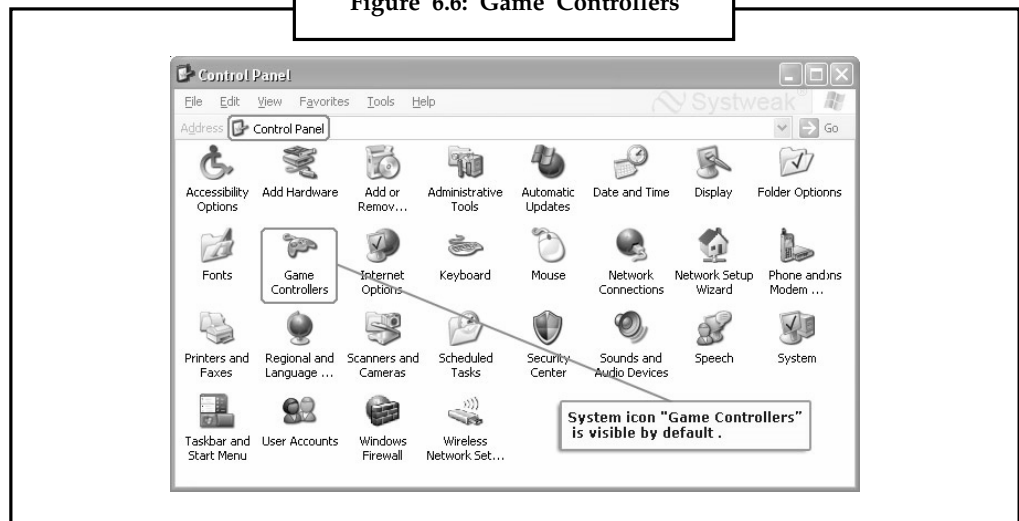

6.5.2 Keyboard

Notes

This icon can be used to change keyboards, adjust the keyboard's speed or to install a keyboard designed for another language. Using this icon, Repeat Delay, Repeat Rate, Cursor Blink Rate can be controlled.

Figure 6.7: Keyboard

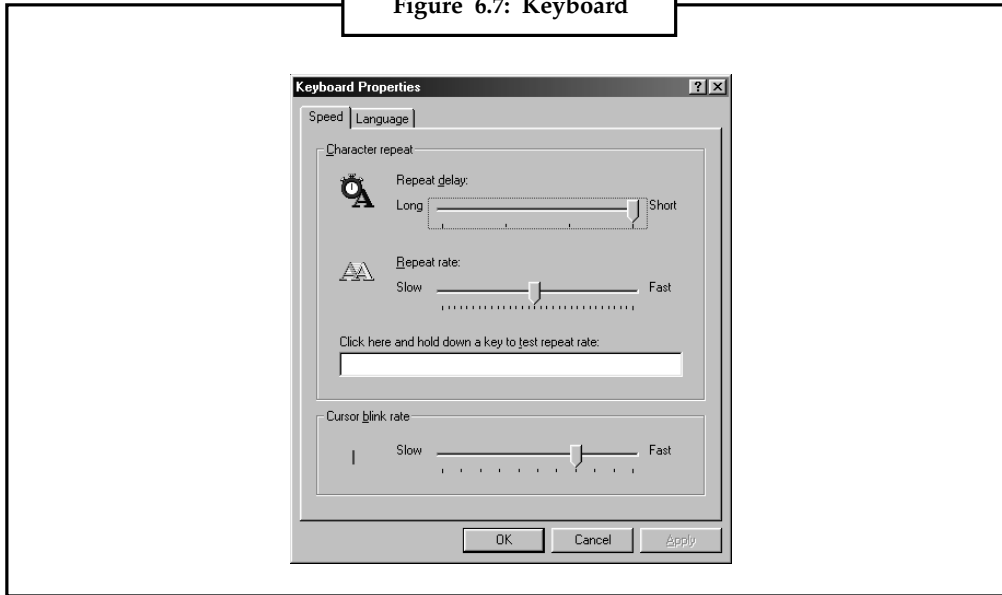

6.5.3 Modems

Modems icon is used to install and control the various settings related to modems.

Figure 6.8: Modems Icon

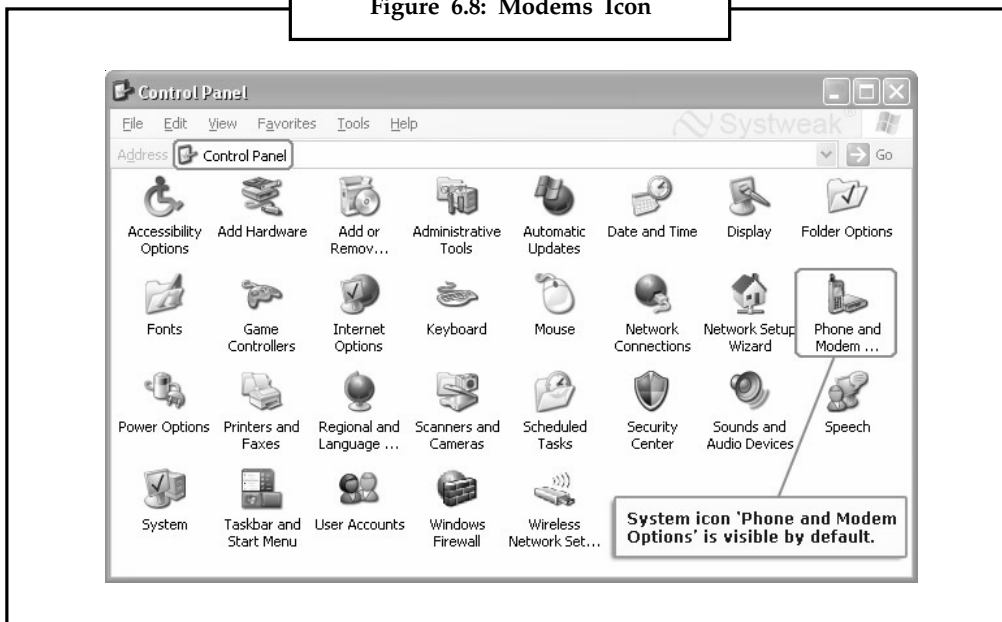

Notes

6.5.4 Mouse

Using this icon, the following settings can be controlled:

- Whether the left or right mouse button is to be used.
- Adjusting the amount of time that can pass between clicks when double clicking the primary mouse button.
- Changing the appearance of mouse pointers according to the available schemes.
- Adjusting the speed at which the mouse pointer moves on the screen.
- Showing the pointer trail and adjusting its length.

Figure 6.9: Mouse Properties (a)

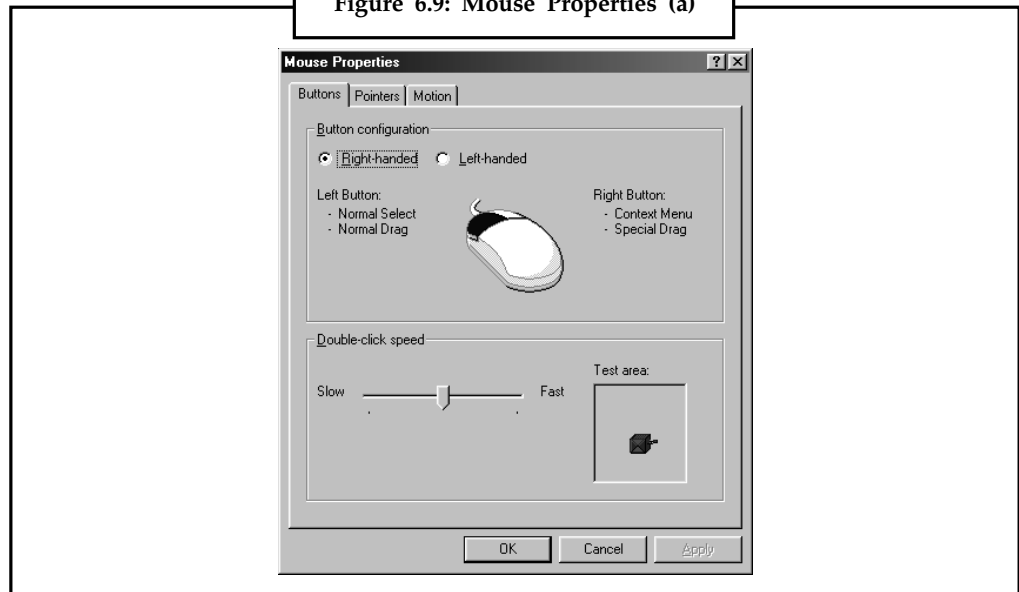

Figure 6.10: Mouse Properties (b)

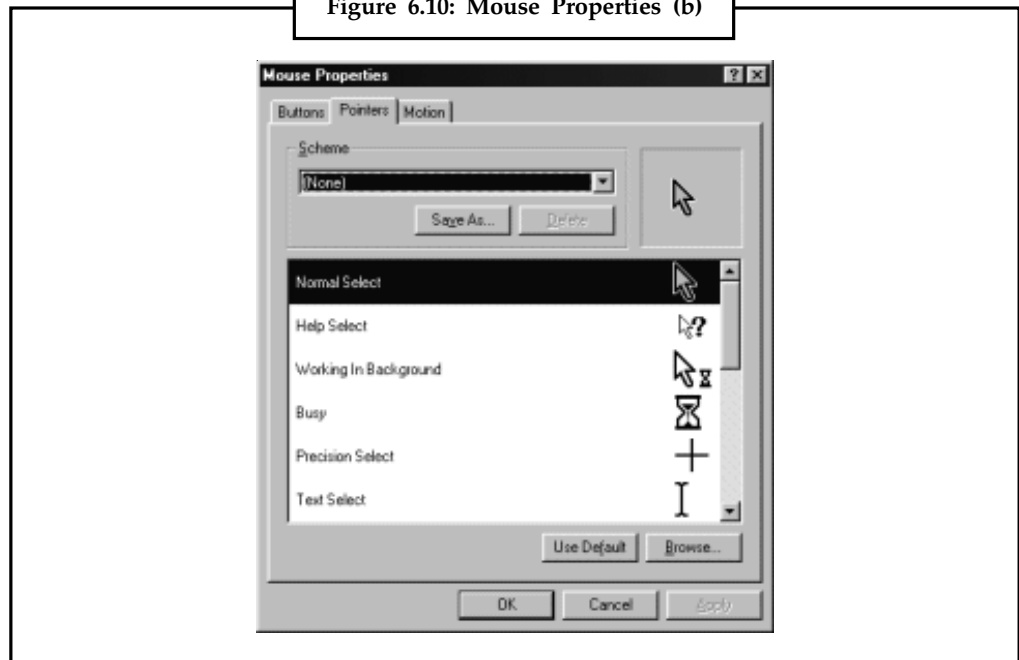
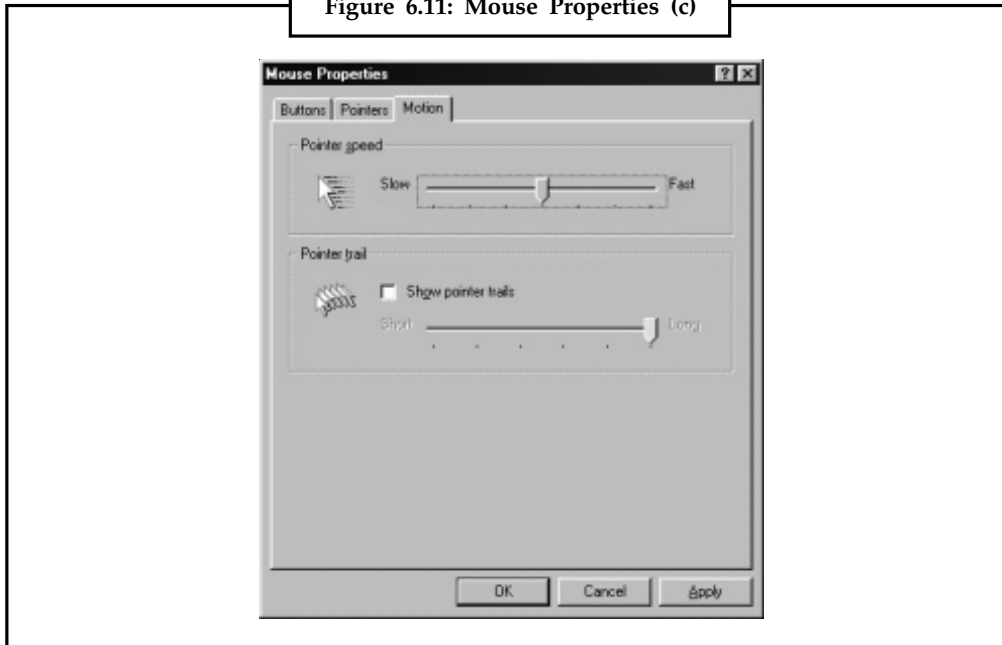

Figure 6.11: Mouse Properties (c)



6.5.5 Telephony

If a modem is installed in the computer that supports voice as well as data, this icon is used to setup the software that controls the voice option of the modem's operation.

6.5.6 Users Accounts

The same computer can be shared by different people. This icon helps in setting up multiple users for the same computer. Each user is able to save his or her own desktop settings, including icons and wallpaper.

6.5.7 The Accessibility Options and Tools

After clicking the "Accessibility option" the following dialog box appears:

Usually people with disabilities such as poor eyesight or hearing find it necessary to install specialized software to make it easier to use the computer. This option eliminates the need to install specialized software for such purposes e.g., using 'Accessibility' options.

- Caption can be displayed for sounds made by both the operating systems and application software.
- Numeric keypad strokes can be substituted for mouse movements and clicks.
- A portion of the screen can be magnified for easier reading.

Accessibility options can be added as a Windows component to make using computer easier. Click the Start button and choose Settings >> Control Panel >> Accessibility options. A dialog box appears having tabs for keyboard, mouse, display and sound settings.

6.5.7.1 Mouse/Keyboard Accessibility

For easy operation of the keyboard and mouse the following options can be put to use:

- **Sticky Keys:** If we have difficulty typing combination keystrokes such as Ctrl+Ese, Shift+F1, or Alt+Z, try using the StickyKeys feature. After enabling StickyKeys option,

Notes

we can make the modifier keys (Ctrl, Alt, and Shift keys) stick after we press them, so we need not hold down that key while pressing the second key in a key+key combination keystroke. Instead, press and release the Ctrl, Shift, or Alt key and then press and release the second key. The modifier (first) key is automatically released after press the second (non-modifier) key.

Figure 6.12: Mouse/Keyboard Accessibility

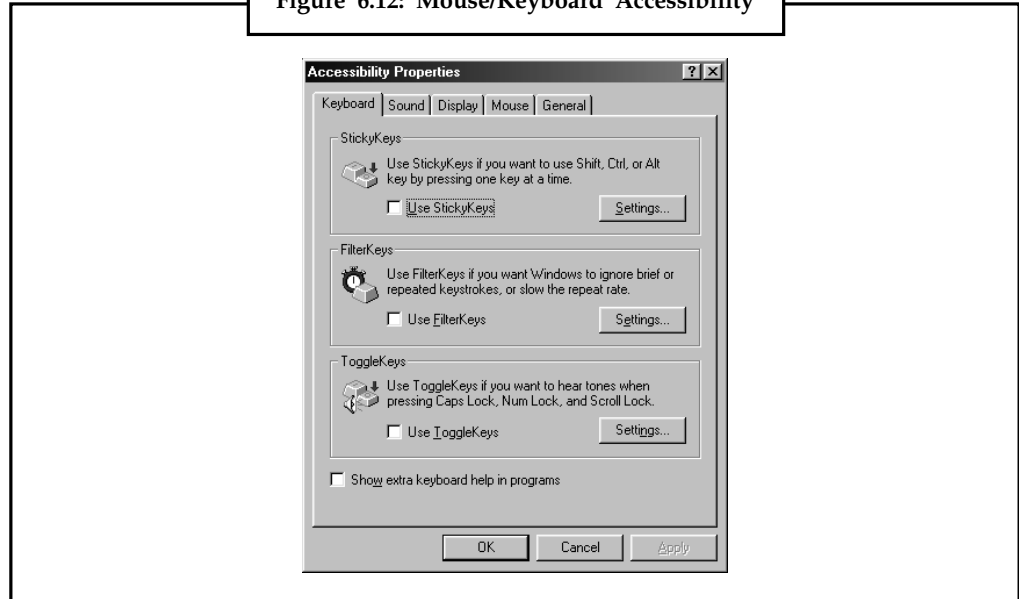

- **FilterKeys:** If you are double-pressing keys by holding them down for too long or typing extra characters because finger brushes the nearby keys, use the FilterKeys option to change the sensitivity of the keyboard.
- **ToggleKeys:** The Caps Lock, Num Lock, and Scroll Lock keys on the keyboard act as toggles, meaning we can press the key to turn the feature on and off. The ToggleKeys options provides an auditory cue that informs us to the status of the key. When one of those keys is turned on, high-pitch sound is played. Turning off one of those keys gives a low-pitched tone.
- **MouseKeys:** MouseKeys enable us to use the keyboard to move the mouse, click things, and so forth. When MouseKeys is activated, we can control the mouse as follows (be sure to use only the keys on the numeric keypad).
- **Move the pointer:** Press (or hold down) the numeric keys surrounding the number 5. The 7, 9, 1, and 3 keys move the pointer diagonally. The 8, 4, 6, and 2 keys move the pointer in the direction of the arrow shown in the key.
- **Click:** Press the 5 key in the middle of the keypad.
- **Double-click:** Press the plus (+) sign key or press the 5 key twice, fast.
- **Drag (left mouse button):** Point to the object, press the insert figure (0) key to begin dragging, use the numeric keys surrounding the 5 to move the mouse pointer and then press Delete (.) to complete the operation.
- **Right-click:** Position the mouse pointer and press the minus (-) sign key. Then press the 5 key to click or the (+) sign key to double-click.
- **Right-drag (right mouse button):** Point to the object you want to drag, press the minus (-) sign key and then press the insert figure (0) key to lock down that button. Use the numeric keys surrounding the 5 to drag. Then press the Delete (.) key to complete the drag.

- **Return to standard clicking:** Press the slash (/) key. This is useful if the mouse button is right-clicking when you want it to click. (If a shortcut menu is open, press Alt or Esc before pressing the slash key.)
- **Click both mouse buttons:** Press and release the asterisk (*) key.
- **Jump the mouse pointer in large increments across the screen:** Hold down the Ctrl key as you move the mouse pointer with the numeric keys.
- **Slow the movement of the mouse pointer:** (as and when you need to position it precisely) Hold down the Shift key as you move the mouse pointer with the numeric keys surrounding the number 5.

6.5.7.2 Sound Enhancements

For the people with impaired hearing, there is a provision to try SoundSentry or Show Sounds. SoundSentry puts up visual cues along with the sounds, so it can be seen when the sound is being played. Show Sounds allows programs that use speech or other audible cues to provide text on the screen.

Figure 6.13: Sound Accessibility Properties (a)

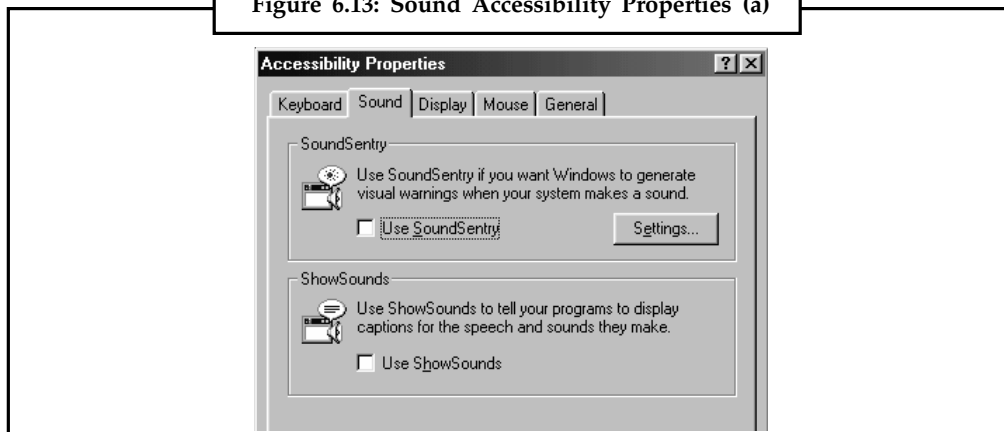

Serial keys Alternative Input Devices: Windows 98 also provides built-in support for alternative input devices including System and head pointers.

Figure 6.14: Sound Accessibility Properties (b)

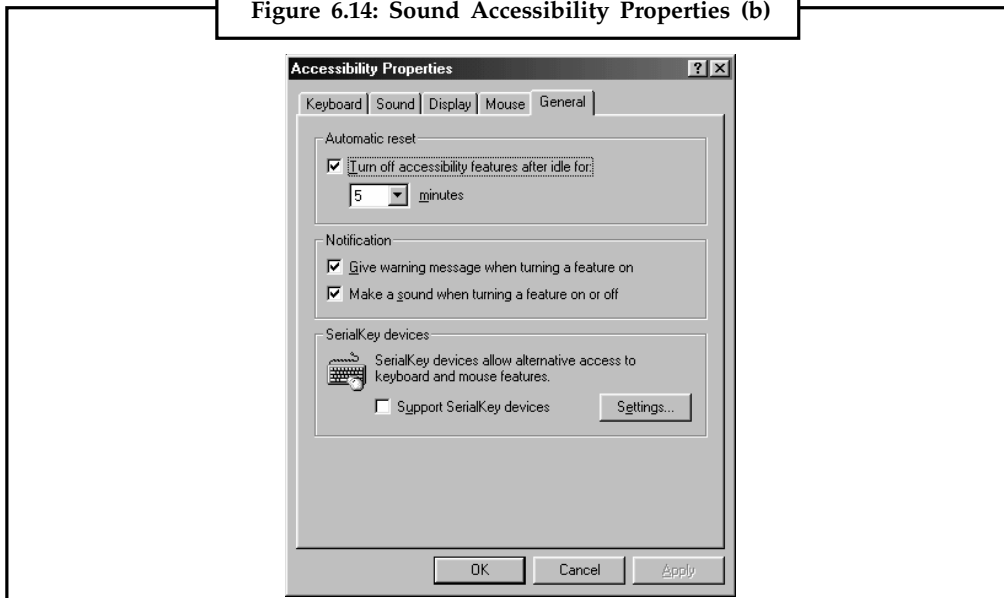

Notes

It is possible to plug any such Serial key device into an available serial port without disconnecting the mouse first.

To give an alternate input device its own serial port, install the device according to the manufacturer’s instructions. Then in the General tab of Accessibility Properties dialog box, select the Support Serial Keys Devices option, and click the Settings button to specify the serial port and baud rate for the alternative input device.

6.5.8 Font Management

The font is defined as a group of letters, numbers and symbols with a common typeface. In Windows 98:

- We can view and print a font sample by choosing Start >> Settings >> Control Panel and clicking the Fonts icon and then double clicking on the desired font displayed in the Fonts window.
- We can find the fonts that resemble each other by choosing View » List Fonts by Similarity. Windows reorders the list to display fonts based on their similarity to the first font in the list.
- New fonts can also be added. In the Fonts window, choose File » Install New Font. A dialog box will appear. Navigate to the drive containing the font(s). Click on OK. Windows installs the fonts.

Figure 6.15: Font Manager

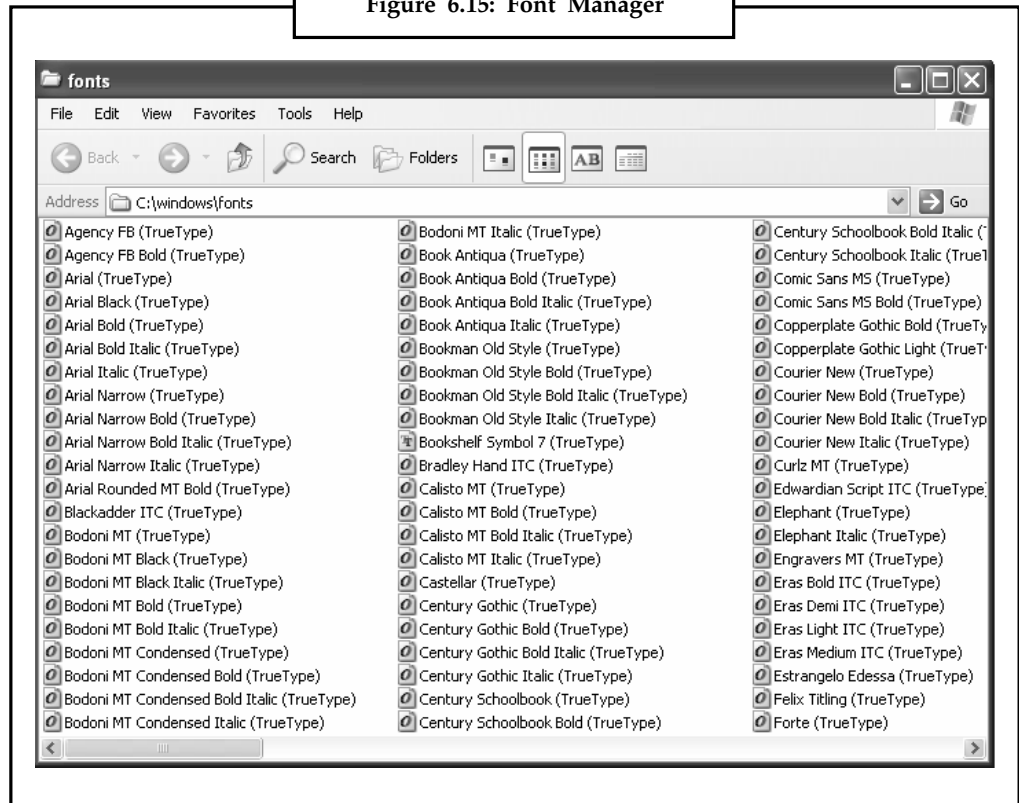

 Task	Which font is used for Hindi typing give the step for selection of fonts.
---	---

Notes

- To delete fonts, open the Fonts window by clicking on the Fonts icon in the Control Panel. Select the fonts to be deleted. Choose File >> Delete. Windows asks to confirm the deletion.

6.5.9 Plug and Play

It is a standard that makes adding hardware device to a PC fairly easy. Plug and Play is a way for Windows 98 to setup new hardware for the computer with little or no human intervention. After simply plugging in the latest hardware, Windows 98 interviews it, checking to see what special settings it needs, and then Windows 98 automatically flips the right switches.

To install new devices, there is an Add New Hardware Wizard. To start this Wizard, Click on the Start button and choose Settings >> Control Panel >> Add New Hardware. The wizard starts and Windows 98 installs the new device by asking some questions.

There may be some devices that are not plug and play—these are termed as legacy hardware. This includes hardware devices designed for DOS and Windows 3.x.

Figure 6.16: Legacy Hardware



6.5.10 Mobile Computing

Many features in Windows 98 make mobile computing much easier. Some of the features are specifically designed for newer laptops with the special plug-and-play BIOS and power management capabilities. The features include:

Notes

6.5.11 Hot Docking and Flexible Configurations

A docking station is an optional device that connects a laptop to a desktop PC. The idea is to give the storage, display and extensibility options of a desktop PC without sacrificing portability. To become mobile, the user simply needs to disconnect his or her PC from the docking station. Many laptops that ship with Windows 98 support “hot docking” which enables us to dock and undock the laptop without even turning it off. In general, laptops can be undocked by clicking the Start button and choosing Eject PC option. Windows 98 automatically detects the impending hardware changes, takes care of any potential problems with open files on an external drive, and loads or unloads appropriate drivers. To redock, simply put the laptop back into the docking station. Windows 98 once again loads the appropriate drivers automatically. Unlike hot docking, cold docking (and undocking) involves completely shutting down the laptop before doing anything.

It is also possible to refine the hardware settings for a particular configuration by following these steps:

1. Click the Start button.
2. Choose Settings >> Control Panel >> System.
3. Click the Device Manager tab and click the plus (+) sign next to any device type to see devices within this category.
4. Open a specific device to see its properties.
5. At the bottom of the dialog box that appears, check the appropriate option whether the hardware should be disabled or removed in the current configuration and choose OK.

Figure 6.17: Docking Station Device

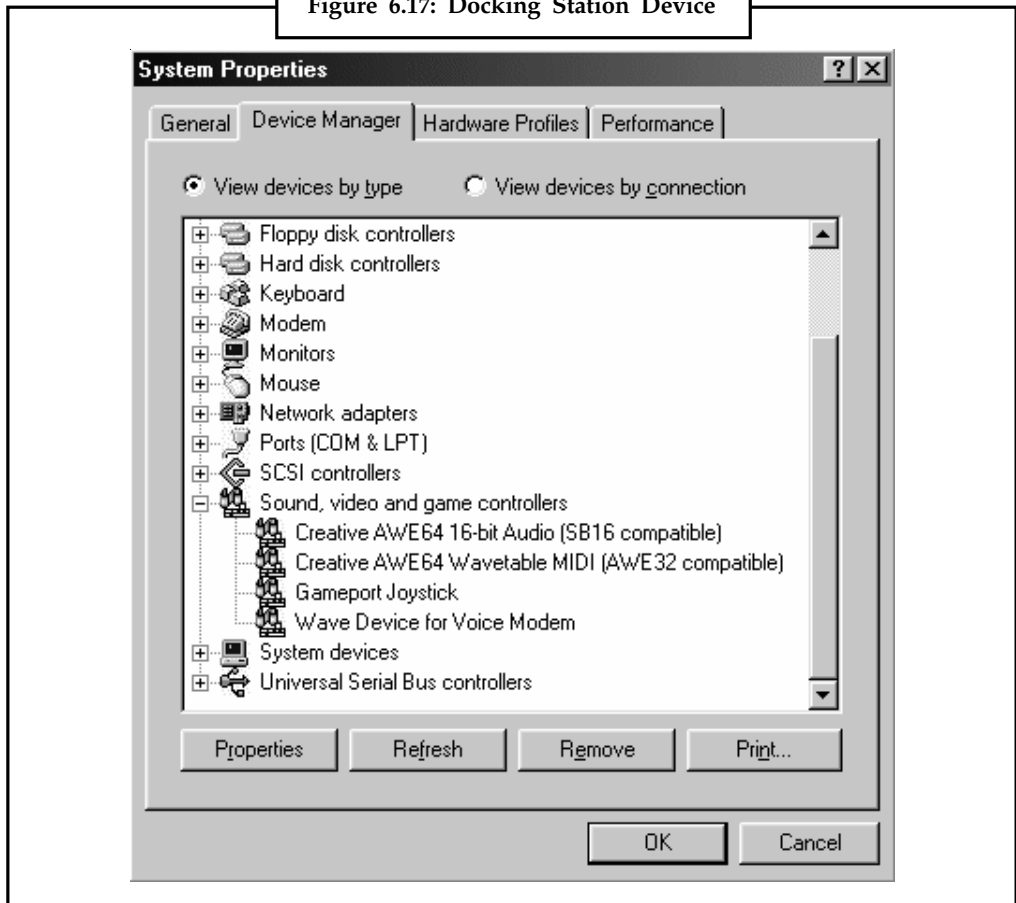

6.5.12 Power Management

Notes

Battery life is a major concern for mobile computer users. Windows 98 supports Advanced Power Management (APM). It is a standard for laptop computers which supports the following features of Windows 98.

- Battery indicator on the taskbar.
- Capability to put the laptop in suspended mode by clicking the Start button and choosing the appropriate option from the menu.
- Capability to configure power management to shut down PC when shut down Windows 98.

Figure 6.18: Power Management Properties (a)

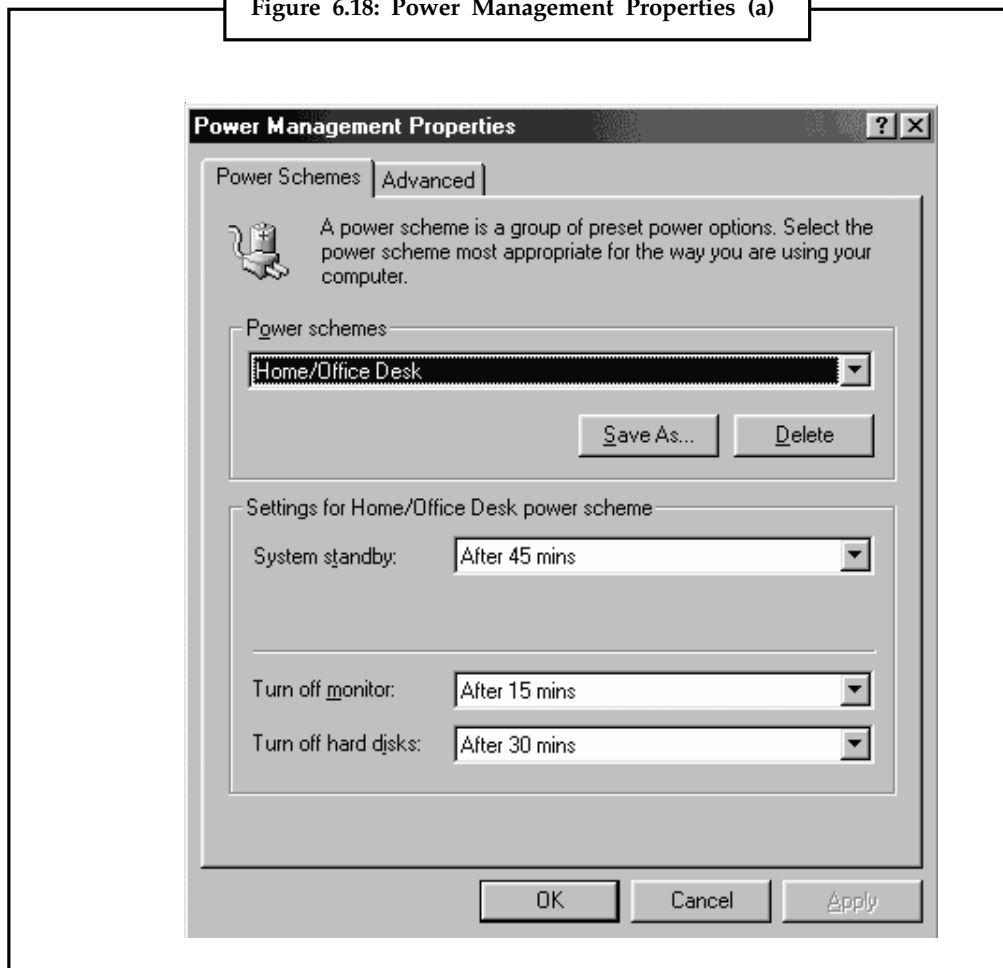

Task

Give the steps for managing monitor power.

Notes

Figure 6.19: Power Management Properties (b)

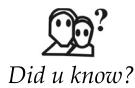
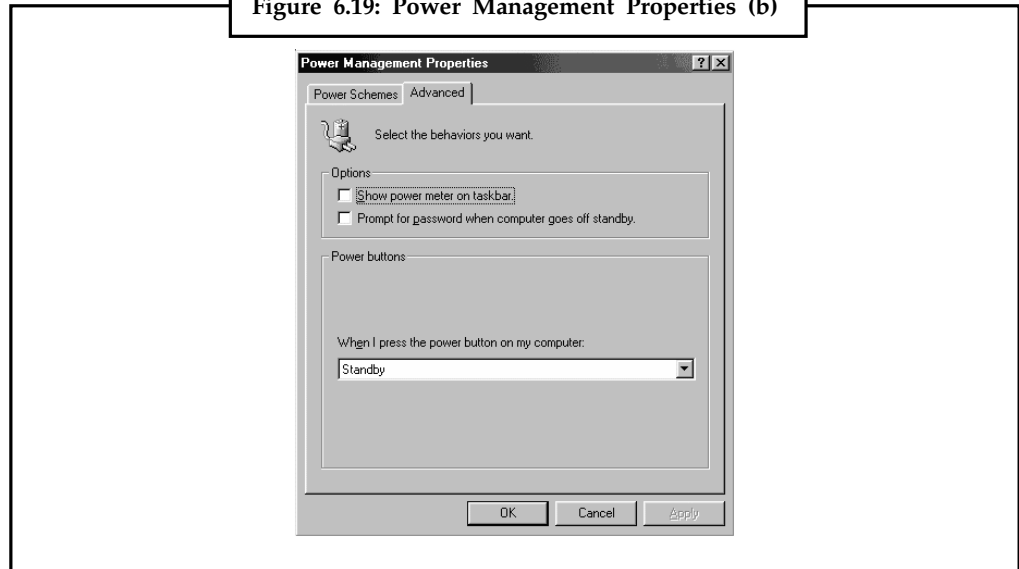

Advanced power management (APM) is an API developed by Intel and Microsoft and released in 1992 which enables an operating system running an IBM-compatible personal computer to work with the BIOS (part of the computer's firmware) to achieve power management.

6.6 Windows Accessories

To start a Windows 98 applet, click the Start button and choose Programs » Accessories. Then click the applet of your choice. Any missing Windows 98 accessories can be reinstalled by using the Windows Setup tab in Add/Remove Programs. The applets are identical to their larger counterparts but possess limited capabilities and features.

Figure 6.20: Windows Accessories

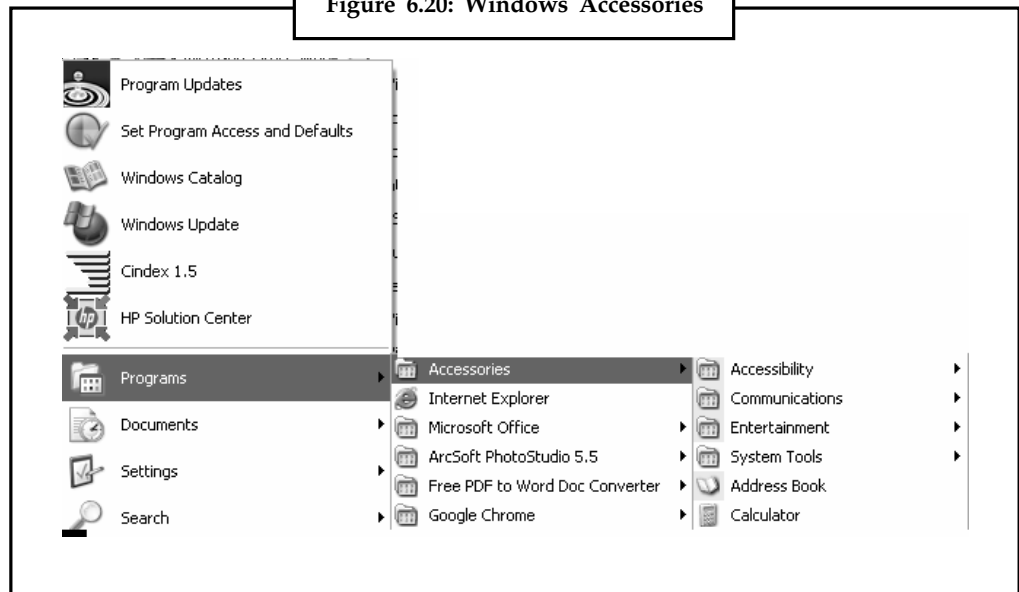

Using this window, the following settings can be controlled:

6.6.1 Multimedia

Notes

Listing of audio hardware available on computer.

Listing of different window sizes available.

- The instruments that play MIDI output can be shown. This facility is normally used by games.
- Listing of CD-ROM drives available in the system.

Figure 6.21: Multimedia Properties

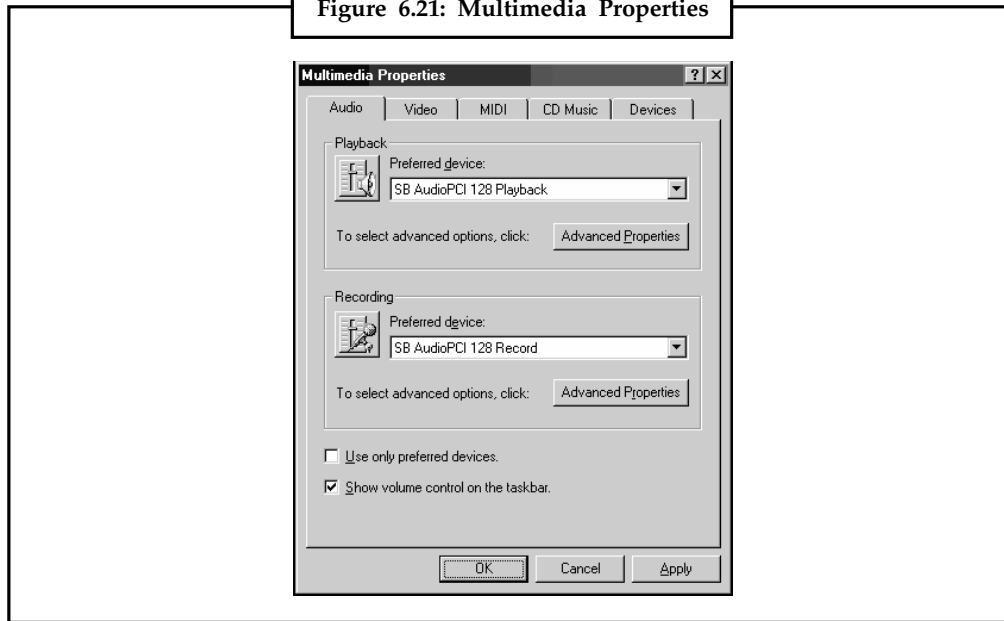

6.6.2 Using the Accessibility Wizard

The easiest way to select and tune accessibility options is through the Windows 98 Accessibility Settings Wizard. To start the Wizard, click the Start button and choose Programs:

- > Accessories > > Accessibility > > Accessibility Wizard.

In the first wizard screen, choose the smallest size of text you can read. Then click the Next button.

Figure 3.22: Administrator

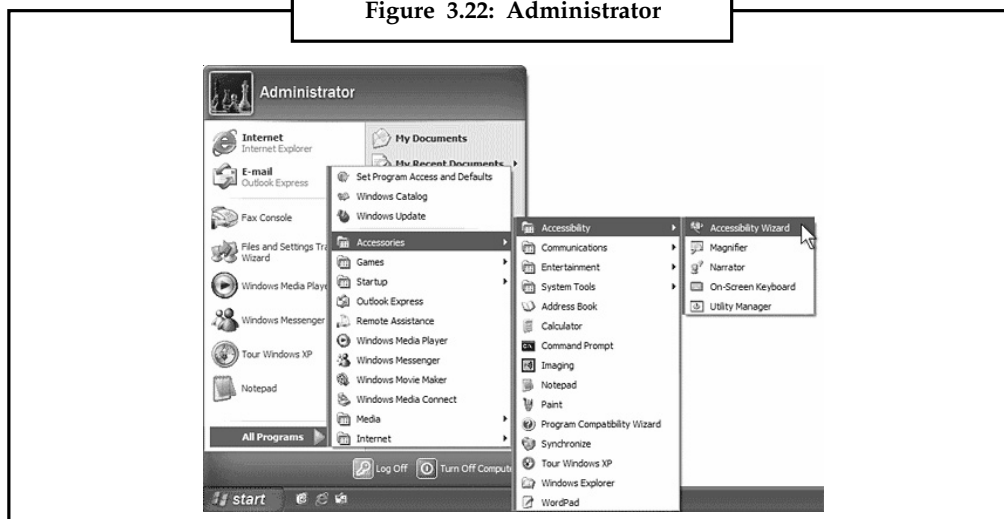

Notes

6.6.3 Magnifier

In Windows 98, there is a new feature called Magnifier. To activate it, click the Start button and choose Programs >> Accessories >> Accessibility >> Magnifier. When this feature is activated, it splits the screen into two halves. The lower half displays text and graphics in normal size. The upper half of the screen magnifies whatever is near the mouse pointer.

To control the regular and the magnified portion size, we can drag - up and down “horizontal bar that separates the two parts of the screen. It is also possible to control, degree of magnification, mouse behaviour, and screen colours using the Magnifier atalog box.

Figure 6.23: Magnifier

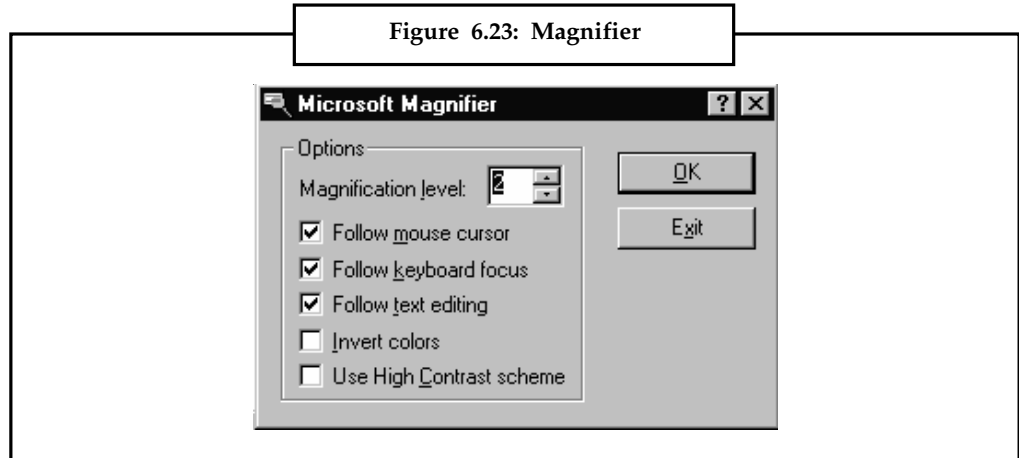

Task

Explaine working of Magnifier.

6.7 Searching Files or Folders

To search for a file or folder:

1. Click **Start**, and then click **Search**.

Figure 6.24: Search File or Folder (a)

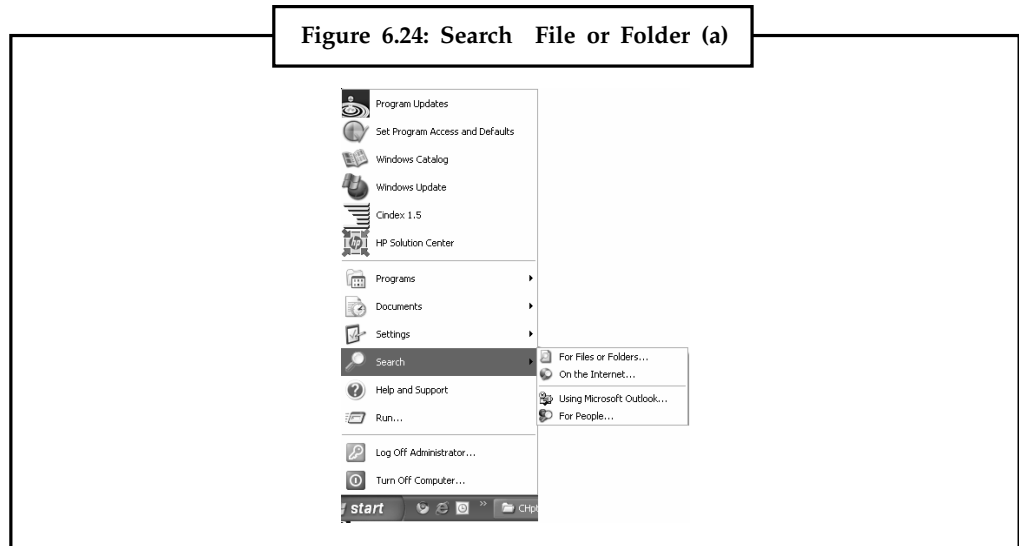

2. In the Search Companion dialog box, click All files and folders.

Notes

Figure 6.25: Search File or Folder (b)

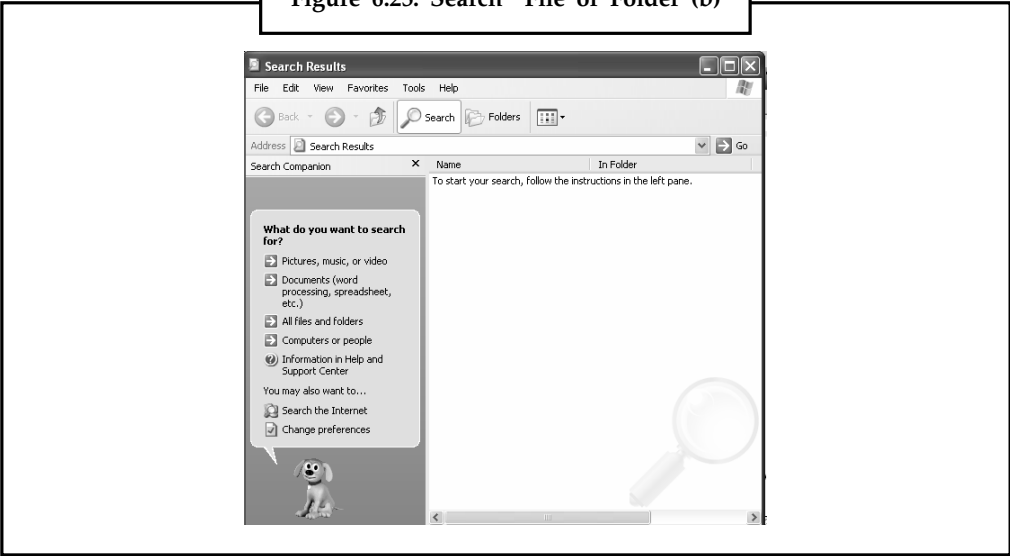

3. Type part or all of the name of the file or folder, or type a word or phrase that is in the file.

Figure 6.26: Search File or Folder (c)

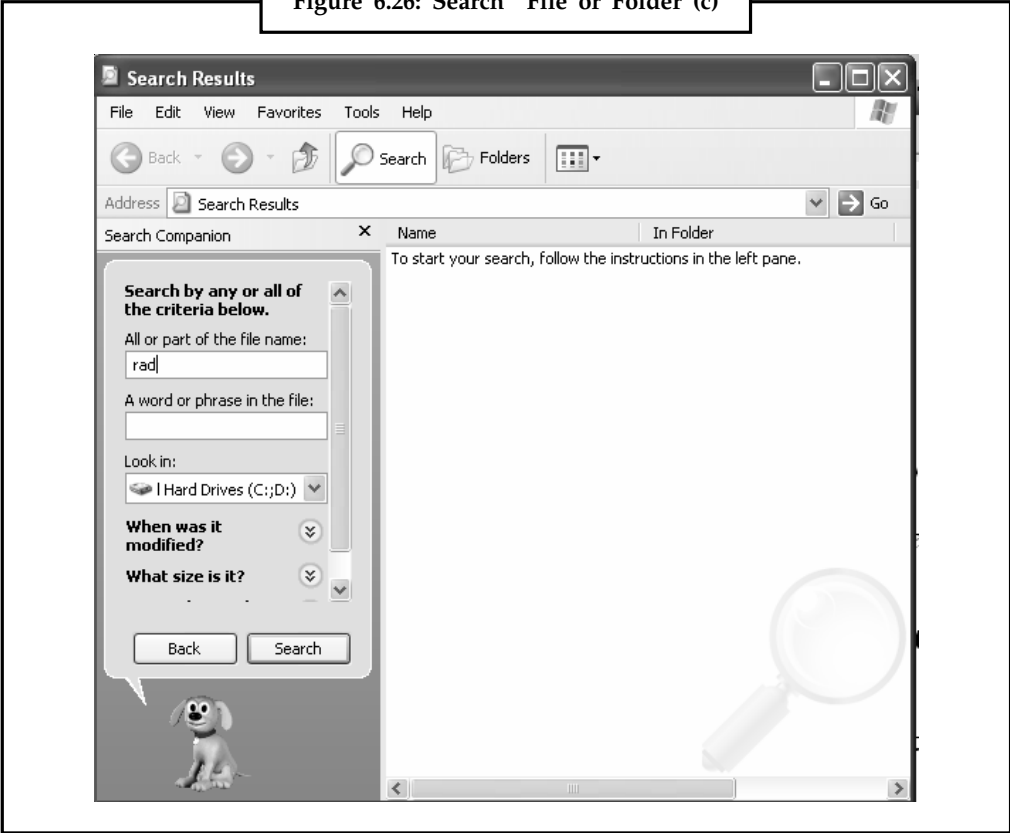

Notes

4. In the **Look in** box, click the drive or drives, folder, or network location that we want to search.
5. Choose one of the following options:
 - (a) Click **When was it modified** to look for files that were created or modified on or between specific dates.
 - (b) Click **What size is it** to look for files that are specific size.
 - (c) Click **More advanced options** to specify additional search criteria.
6. Click **Search**.



If you are searching any file give the related file name otherwise file will be not find.



“Search Companion” is the name of the left hand pane that appears in the Search Window under Windows XP when we select **Search, For Files or Folders**.

Figure 6.27: Search Companion (a)

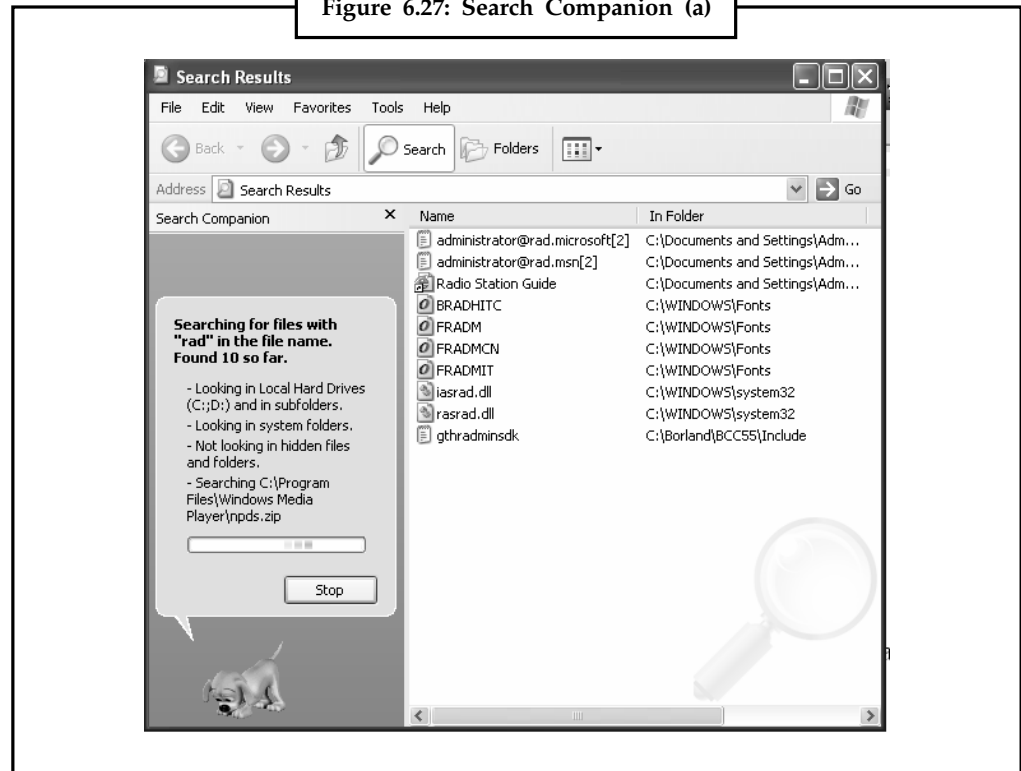

7. Searching is finished.

Figure 6.28: Search Companion (b)

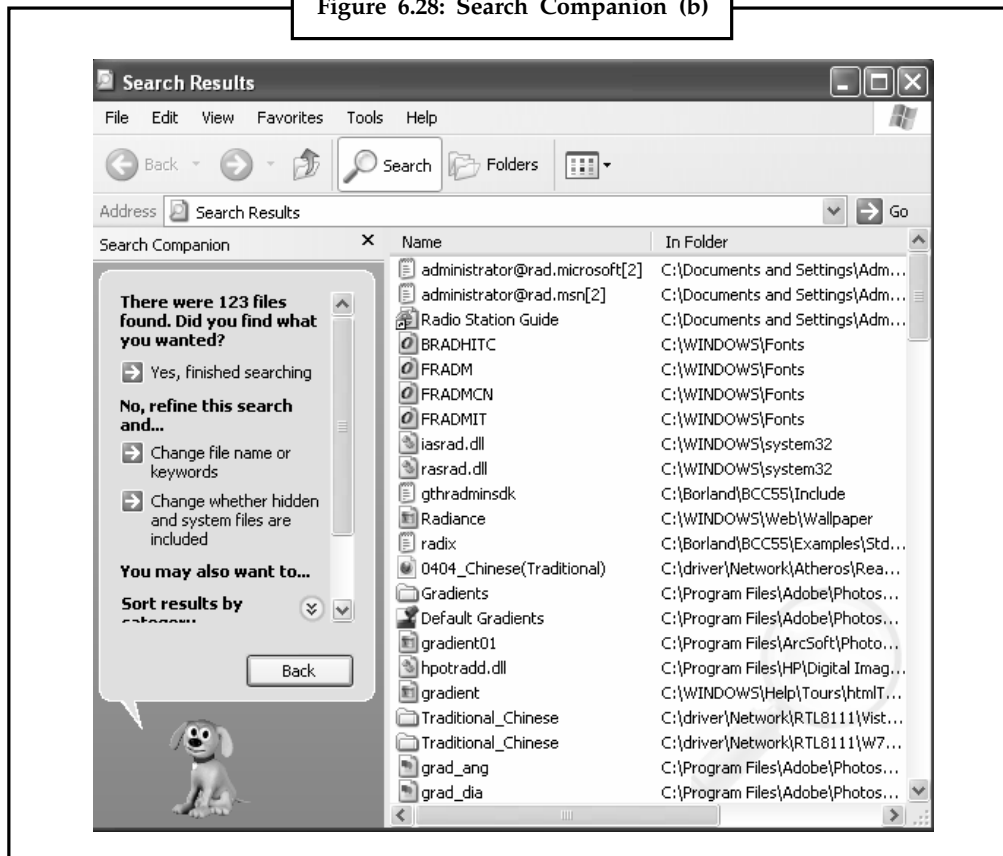

6.8 Summary

- Windows Explorer is a folder/file-management program used to view and change the contents of folders and files and structure of disks.
- The task base, is used to bring any open window from hiding simply by dusking its taskbar button.
- The title bare offers the handling the feature of window like expanding window etc.
- Control panel handle the all setting of computer system.
- Windows accessories comes under which we explained multimedia and magnifier.
- Search folder is used for searching the files and folder in computer system memory.

6.9 Keywords

Advanced power management (APM): It is an API developed by Intel and Microsoft and released in 1992 which enables an operating system running an IBM-compatible personal computer to work with the BIOS (part of the computer's firmware) to achieve power management.

Filterkeys: It is a feature of Microsoft Windows. It is an accessibility function that tells the keyboard to ignore brief or repeated keystrokes, in order to make typing easier for people with hand tremors. The feature and the keyboard shortcut that activate it (hold !Shift for 8 seconds) can be turned off via the Accessibility icon in the Windows Control Panel.

Notes

Magnifier: It is a display utility that makes the computer screen more readable by people who have low vision by creating a separate window that displays a magnified portion of the screen. Magnifier provides a minimum level of functionality for people who have slight visual impairments.

Mobile computing: It is a form of human-computer interaction where a computer is expected to be transported during normal usage. Mobile computing has three aspects: mobile communication, mobile hardware and mobile software.

Multimedia: It is media and content that uses a combination of different content forms. The term can be used as a noun (a medium with multiple content forms) or as an adjective describing a medium as having multiple content forms. The term is used in contrast to media which only use traditional forms of printed or hand-produced material. Multimedia includes a combination of text, audio, still images, animation, video, and interactivity content forms.

Search companion: It is the name of the left hand pane that appears in the Search Window under Windows XP when we select **Search, For Files or Folders**.

Sticky keys: It is an accessibility feature to help computer users who have physical disabilities, but it is also used by others as a means to reduce RSI (or a syndrome called the Emacs Pinky). It essentially serializes keystrokes instead of pressing multiple keys at a time: StickyKeys allows the user to press a modifier key, such as Shift, Ctrl, Alt, or the Windows key, and have it remain active until any other key is pressed.

Title bar: The title bar is the bar that runs horizontally across an application window. The title bar will contain either the name of the file for example, a document we are viewing or the website we are viewing through Internet browser. Find out how to use, customize and install add-ins to title bars.



Lab Exercise

1. Explain all Windows Accessories.
2. Search Files or Folders.

6.10 Self-Assessment Questions

1. If you are double-pressing keys by holding them down for too long or typing extra characters because your finger brushes the nearby keys, use the StickyKeys.
(a) True (b) False
2. Start menu contains
(a) Windows Update (b) Programme
(c) Favorites (d) All of these
3. Which handy features the title bar offers?
(a) To move a window to a from a location to new location on the screen drag the window by its text bar
(b) To expand a window to full screen size or to shrink it back to its original size, double click its title bar.
4. Explorer application window is divided into four panes:
(a) False (b) True
5. What is the major concern for mobile computer users?
(a) Memory (b) Programme
(c) Battery life (d) All of these

6. To control the regular and the magnified portion size, you can drag horizontal bar that separates the two parts of the screen. Notes
- (a) Up and down (b) Right
(c) Left (d) Right and left
7. What is Search Companion?
(a) Name of the right hand pane (b) Name of the left hand pane
8. What is multimedia?
(a) Media and content (b) Media
(c) Content (d) All of these

6.11 Review Questions

1. Define role of taskbar.
2. What is the Start button used for?
3. Explain Windows Accessories.
4. Name the special toolbars offered by windows 98.
5. How does Windows XP organize files and folders on drives?
6. How do you open Windows Explorer?
7. How do you remove an item from the Start menu or from a Program menu?
8. How will you use Accessibility wizard?

Answers for Self-Assessment Questions

- | | | | |
|--------|--------|--------|--------|
| 1. (a) | 2. (d) | 3. (b) | 4. (a) |
| 5. (c) | 6. (a) | 7. (b) | 8. (a) |

6.12 Further Readings



Books

A Study of Computer Fundamental, Shu-Jung Yi.
Fundamental Computer Concepts, William S. Davis.



Online link

<http://books.google.co.in/bkshp?hl=en>

Unit 7: Microsoft Word Introduction

CONTENTS

Objectives

Introduction

- 7.1. Introduction to Microsoft Word
 - 7.1.1 Microsoft word 2000
 - 7.1.2 Word 2000 Features
- 7.2. The Word Environment
 - 7.2.1 Microsoft word 2007
 - 7.2.2 Microsoft word 2000
- 7.3. Creating a Word Document
- 7.4. Editing in a Word Document
 - 7.4.1 Typing in a Document
 - 7.4.2 Displaying Nonprinting Characters
 - 7.4.3 Moving Around In a Document
 - 7.4.4 Using Go To Command
 - 7.4.5 Manipulating Windows
 - 7.4.6 Selecting Text
 - 7.4.7 Editing Text
- 7.5. Saving a Document
 - 7.5.1 The Save Options: Fast Save or Full Save
 - 7.5.2 Saving a File With a new name
- 7.6. Printing Documents
 - 7.6.1 Using Print Preview before Printing
- 7.7. Exiting Word
- 7.8. Opening a Document
- 7.9. Finding Files
- 7.10. Word's Document Views
 - 7.10.1 Normal View
 - 7.10.2 Print Layout View
 - 7.10.3 Outline View
 - 7.10.4 Web Layout View

7.10.5 Full Screen View
7.10.6 Web Page Preview
7.10.7 Print Preview
7.10.8 Zoom
7.11 Summary
7.12 Keywords
7.13 Self-Assessment Questions
7.14 Review Questions
7.15 Further Reading

Objectives

After studying this unit, you will be able to:

- Understanding and explanation of microsoft word
- Explanation of word environment in micro soft word
- Process of using or creating a word document
- Explanation of editing in a word document
- Process of saving a document in word
- Explanation of opening a document
- Process of finding files
- Understanding of word document views

Introduction

More than 85 percent of the personal computers in existence today are equipped with word processing programs. Word processing programs allow you to write, edit, format, save, and print a document with ease. Using word processing software, you can produce a high-quality document in much less time than if you used a typewriter. The reason is that word processing software separates document creation from document printing. With a word processing program, you can enter your work without being concerned about how the document will appear. Editing your document is much easier and more efficient with a word processing program. You can use your creativity to format the documents. Formatting is the process of adjusting the appearance of the document.

A few special features most word processing programs include are: spell-checker, chesaurus, style and grammar checker, mail-merge, and macros. Word Star, Word Perfect and MS Word are few popular word processing programs.



Did u know?

One of the main advantages of a word processor over a conventional typewriter is that a word processor enables you to make changes to a document without retyping the entire document.

7.1 Introduction to Microsoft Word

7.1.1 Microsoft Word 2000

Microsoft Word is a word processor, created by Microsoft Corporation, US. It is one of the most advanced and powerful word processing software packages in the market. It replaces your pen, paper, dictionary, thesaurus, and typewriter, and helps the user to create professional documents in record time.

With the help of Word, users can write letters, memos, faxes, brochures, newsletters, and even books. Word and Microsoft Office are integrated to give greater flexibility and also provide a document-centric approach rather than an application-centric approach.

Microsoft Word strives to provide more interconnectivity between the user and the world by linking Word documents to the Word Wide Web and between the user and other office-mates by allowing many people to edit the same document without confusion.

Microsoft Word 2000 is a word processing program designed for Windows 98 and Windows NT 4.0 and later. Word can integrate information with other Microsoft Office products such as Excel and PowerPoint. For example, you can create a document in Word and send the documents outline to PowerPoint.

7.1.2 Word 2000 Features

Microsoft's objective in this version is to make Word the easiest way to create e-mail, Web, or print documents anywhere in the world. The new features added in Word 2000 are directed at the following areas:

- Web-centred document creation
- Rich e-mail creation
- Personalization based on patterns of use
- Support for international users

7.1.2.1 Web-Related Features

- **Preserved Formatting:** When existing documents are saved as HTML and then reopened, none of Word's formatting will be lost.
- **Improved Web Page Wizard:** The Web Page Wizard gives you an easy and quick way to create web pages and multiple-page web sites.
- **Web Layout View:** This new view replaces the old Online Layout view and makes it easier to create, edit, and view web pages.
- **Themes:** Themes set up consistency between your web pages to unify a site.
- **Improved Web Page Preview:** You can preview your web pages in your default browser, even if you have not saved them yet.
- **Improved Hyperlink Interface:** It is easier to create, edit, follow, and remove hyperlinks in documents.

7.1.2.2 International Features

- **Language Settings:** Users can adjust the language setting in the application without affecting the operation of Word.
- **Proofing Tools:** Users can install proofing tools for their preferred language.
- **Language AutoDetect:** Word automatically detects the language users type in, so tools such as spelling and grammar checking adjust to accommodate the preferred language.

- **Asian Languages:** Word users can now type in Japanese, Korean, and Chinese even though they are using Western operating systems.

7.1.2.3 General Features

- **The Office Assistant:** It is a gateway to all Word Help resources. It uses an advanced technology that recognizes natural language patterns, not just keyword location.
- **Internet, Intranet, and WWW features:** All the resources of the WWW are at the user's disposal. Help files, access to new features as soon as they become available, and the ability to build hyperlinks right into documents are just some of the new features that Word offers.
- **Drawing Tools:** Microsoft Word provides a rich collection of 3-D shape creation tools, auto shapes, shadow effects, textures, and semi-transparent fills. It includes a toolbar just for drawing tools. It also provides unique layering possibilities for the documents.
 - ❖ **Editing and Proofing Tools:** Word checks grammar as the user types. It provides tips to improve the writing skills tighten up grammar and sentence structure, verb agreement, and so on. It also has improved Spelling and Find capabilities. It recognizes many proper nouns, figures of American speech, and company names.
- **Template and Wizards Features:** Word's template are read-only documents containing styles and other design elements that you can use to create or restyle your own documents. Wizards are computerized assistants that are used to create documents, after asking some questions and making a few design decisions on their own.
- **Mail Merge Tool:** Word's Mail Merge feature allows you to quickly create personalized correspondence and other documents by combining (merging) information from two different files.

7.1.2.4 Requirements for Running Word 2000

Many people purchase Word 2000 as part of the Microsoft Office 2000 suite of applications, which also includes such applications as Excel, PowerPoint, and Access. If you are installing Word as part of Microsoft Office 2000, you have the option of installing all of the Office applications or some of the applications. You need to decide which applications you want to install before you begin.

To install Word as part of Microsoft Office, your system must meet the following requirements:

- The operating system on your computer must be Windows 95, Windows 98, or Windows NT Workstation 4.0 with Service Pack 3.
- Your computer must be at least an x86-compatible PC that meets the minimum requirements to run Windows 98 or Windows NT Workstation 4.0. Microsoft recommends a 90 MHz Pentium or better with at least 32 MB RAM.
- Your hard disk should have 250 MB of available space.
- Windows NT users need 4 MB of free Registry space available.
- If you plan to install International support for additional languages, you need an extra 50 MB of hard disk space available for each language interface you want to install.
- You must have a CD-ROM drive.

Notes

- A mouse or other pointing device.
- A printer supported by Windows 95 or Windows 98, preferably a laser printer.

7.1.2.5 Starting Word

Use one of the following three methods to activate Word:

- Click the Start menu button and choose Microsoft Word from the Programs menu.
- Click the Start menu button, choose Microsoft Office from the Programs menu and then select MS-Word.
- Choose Start » Run, enter the path and program name in the Open text box and then click the OK button to start Word.

Word can be started automatically, whenever Windows starts, if Word is placed (WinWord.exe file) into Startup folder in the Start menu.

7.1.2.6 Opening Documents Automatically

To start Word and open a document named Letter.doc that is stored in a folder named Docs on the C drive:

- Click the right mouse button on shortcut icon for Word.
- Add a document filename after the program named in the Target text box:

“C:\Office\Winword.exe” “C:\Docs\Letter.doc”



If you want to use Microsoft word make sure the MS office is successfully installed in your computer system.

7.2 The Word Environment

7.2.1 Microsoft Word 2007

Microsoft Office Word 2007 is a sophisticated word processing program that helps you create, edit, and produce professional-looking documents. Word 2007 has been extensively overhauled and updated from the previous versions. It presents a complete set of writing tools in a new graphical user interface. These tools are easier to find and allow you to give your document a consistent look when adding styles, impressive graphics, columns, and tables. This manual will serve as both an introduction to Microsoft Word 2007, as well as a guide to better assist your transition from Word 2003 to Word 2007.

7.2.1.1 Getting Started

In order to access Word 2007, you will need to do one of the following:

- Double-click the shortcut on your desktop (if applicable), or
- Navigate to Word 2007 through the Start Globe button > AH Programs > Microsoft Office.

Fig. 7.1: Microsoft Word 2007 Windows

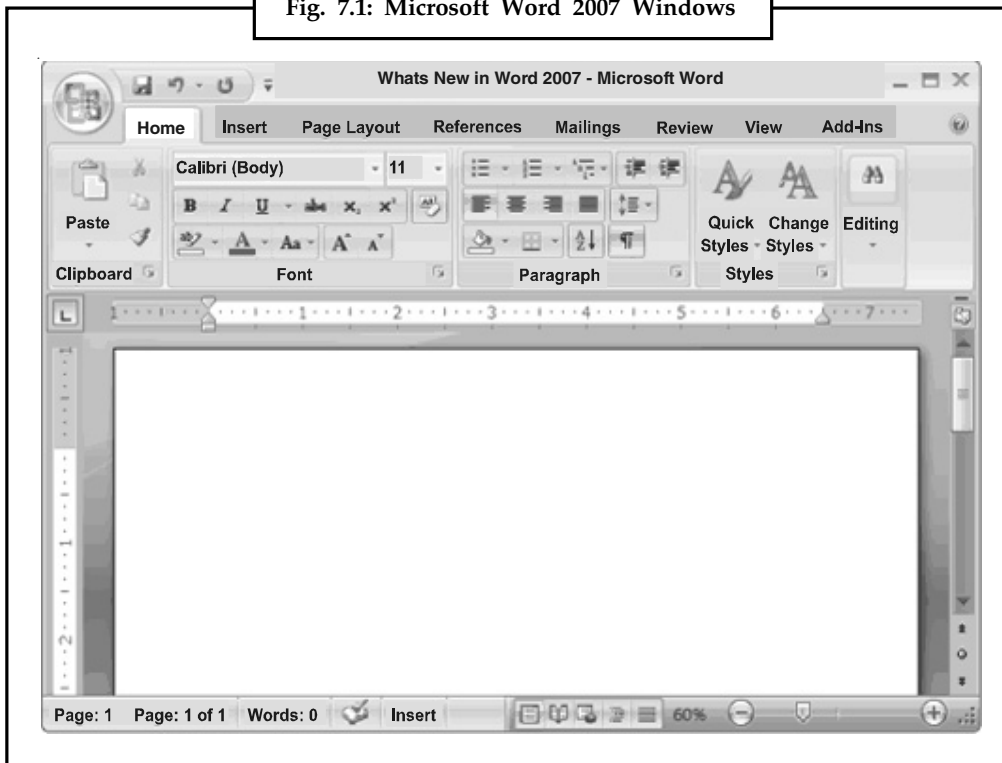

What's New

Word 2007 presents a new user-interface which is quite different than previous versions of Word. This section will provide you with some basic information about the new look and features available in Word 2007 in order to help you get started.

Fig. 7.2: Descriptions of MS 2007 Windows

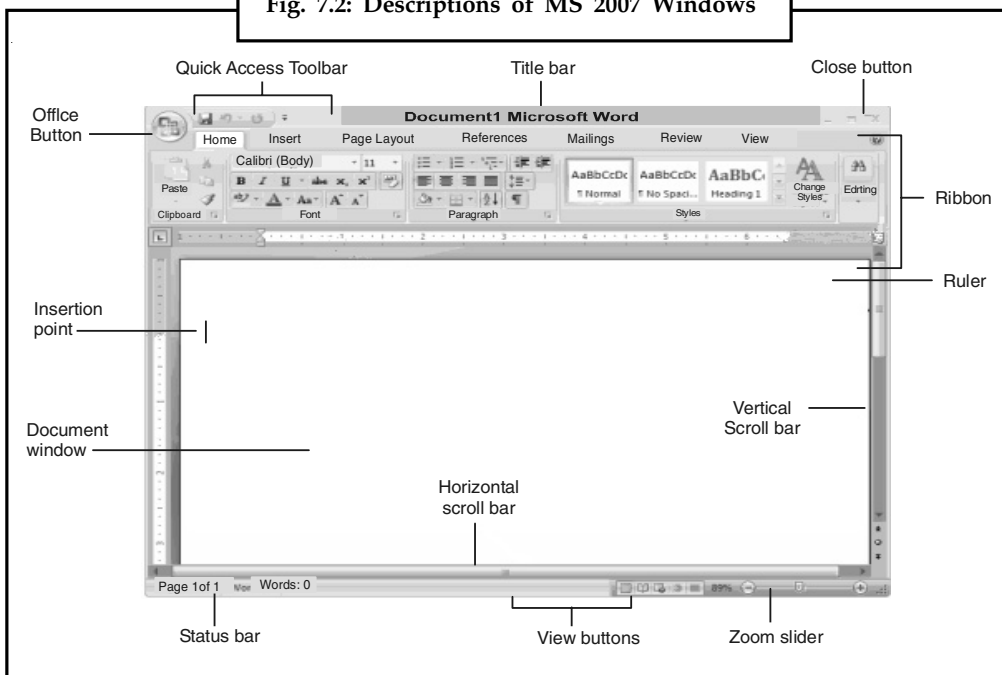

Notes

7.2.1.2 How to Create a New Blank Document

In order to create a new document in Word 2007, follow the steps below:

1. Click the Microsoft Office Button  and select New.
2. Click the Create button

Keyboard Shortcut: CTRL+N

7.2.1.3 How to Open an Existing Document

1. Click the Microsoft Office Button  and select Open.
2. From the resulting menu, navigate to the existing document you wish to open.
3. Once you have selected your document, click the Open button.

Keyboard Shortcut: CTRL+O

7.2.1.4 How to Change Document View

1. Select the View tab.
2. Select your preferred view option from the Document Views group; or

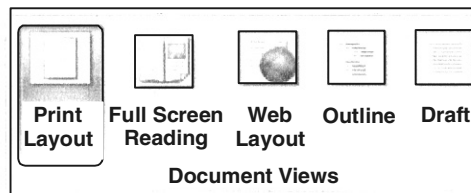

3. Click a View Button on the View toolbar in the lower right corner of the Status Bar.

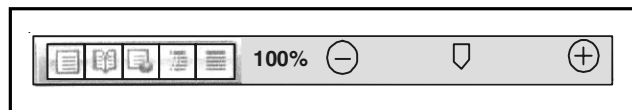

- Print Layout view A view that shows a document as it appears on a printed page.
- Full Screen Reading view A view that displays as much of the content of the document as will fit in the screen.
- Web Layout view A view that shows a document as it appears in a web browser.
- Outline view A view that shows the structure of a document, which consist of headings and body text.
- Draft view A view that displays the content of a document with a basic layout.
- Zoom button The Zoom button magnifies or reduces the contents in the document window.

7.2.1.5 How to Save a File

Notes

1. Click the Microsoft Office Button  and select Save.
2. Navigate to the location to save your file.
3. Enter the name for the new file in the File name box.

Keyboard Shortcut: CTRL+ S

7.2.1.6 Compatibility Mode and Converting Documents

You may find that there are times you need to access and edit files created in previous versions of Word (for example, you are working on a document with a colleague who is still be running Word 2003). The below information will provide you with the resources you need while working with these documents.

7.2.1.7 Compatibility Mode

When you open a document created in previous versions of Word, Compatibility Mode is turned on and you will see Compatibility Mode in the title bar of that document window. While you are able to open, edit and save documents created in previous versions of Word, you will not be able to use any of the new or enhanced Word 2007 features.

7.2.1.8 Convert a Document to Word 2007

1. Click the Microsoft Office Button, and then click Convert.
2. From the Microsoft Office Word dialog box, click OK.

Initially, Word displays a new document that is based on a Normal template (NORMAL.DOT) in full-screen size. Word's Normal template determines the initial settings.

- **The Title Bar:** The title bar at the top of the screen displays the program name (Microsoft Word), document filename (Document1), Word control menu, and the three buttons on the upper-right corner of the screen to either minimize or restore, or exit document, respectively.
- **The Menu Bar:** Just below the title bar is the menu bar. It contains drop-down menus.
- **Toolbars:** By default, the Standard and Formatting toolbars are displayed just below the menu bar. Additional toolbars are available for different features. Choose View >> Toolbars to show or hide any of Word's toolbars.



Did u know?

If no toolbars are displayed, click the **View** menu, choose **Toolbars** and then select the desired toolbar from the list. By selecting **Customize** at the bottom of the list, you can choose to enlarge the toolbar buttons, add color to some of the buttons, and hide ToolTips.

- **The Ruler:** The horizontal ruler is displayed across the top of the document window and enables to change paragraph indents, adjust margins, change the width of newspaper style columns, change the width of table columns and set tab stops. To display and hide the ruler, choose the View >> Ruler command.

Notes

- **The Status Bar:** The first section of the status bar shows the current page number, the section number and the total number of pages in the document. The next portion shows the distance (in inches) from the top edge of the page to the insertion point, followed by the insertion point's line and column numbers. The last section displays the current time and modes. To turn it off choose the Tools >> Options command. Select the View tab and click the Status bar check box.
- **The Style Area:** The vertical pane along the left edge of the document window displays the style name for each paragraph visible in the window. To display or hide the style area, follow these steps:
 - Choose View >> Normal (only available in Normal and Outline views).
 - Choose Tools > > Options.
 - Choose Window tab, specify width in the Style Area Width box. For example, enter 0.5".
 - Click OK button.

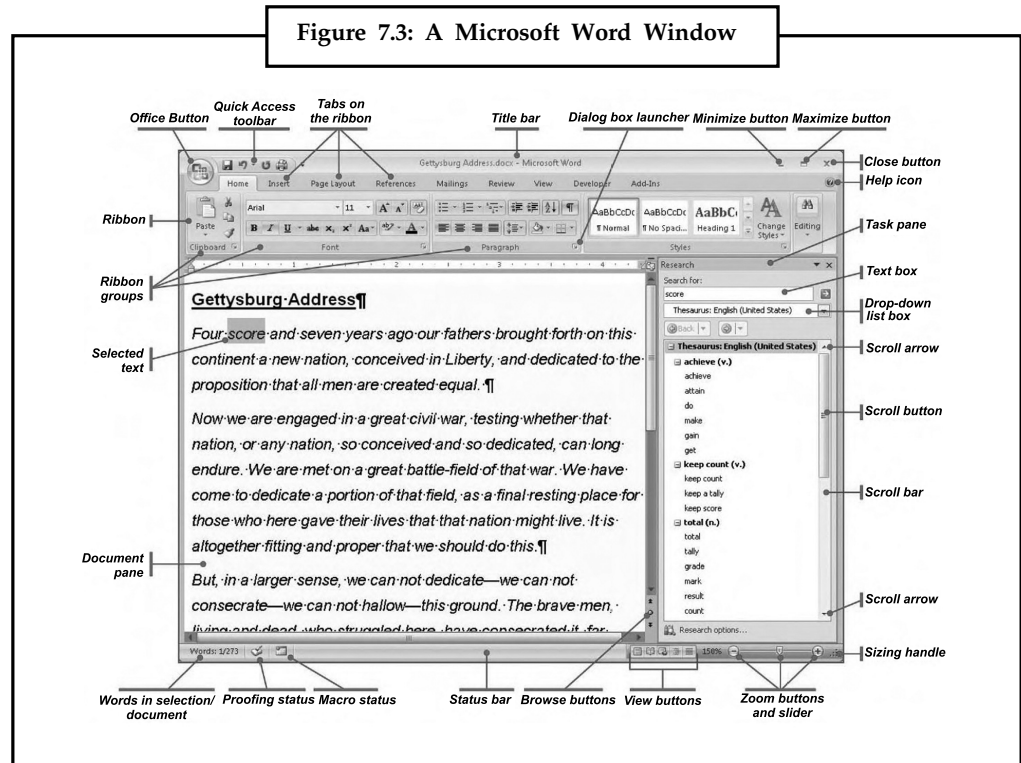



To hide the style area, drag the style area boundary to the left until the style names disappear.

Notes

- **The Document Window:** One can create, edit, format, and view the document files in the document window. The blinking vertical bar is called the insertion point. It indicates where text is to be entered into a document.
- **The Scroll Bars:** The vertical and horizontal scroll bars, which are a part of the document window, are used to scroll the document either from top to bottom or bottom to top and from left to right or right to left respectively. The horizontal scroll

bar also contains buttons that allow to switch quickly between the four most common document views.

- **The Office Assistant:** When Word starts, a little paper clip icon appears on the lower right corner of the screen. Office Assistant is best bet to get help with Word. Office Assistant is intelligent and specific, and it can get to the heart of a matter quickly. To change the clip icon, right click it, select and choose Assistant. To close it, click the Close box and clicking the question mark on the Standard toolbar brings it back.

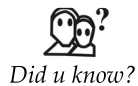

Word also has the facility of macros. Macros can be either attached to some function/special keys or to a tool bar or to a menu.

Help Menu

Show Balloons: If you are not sure what a menu does, turn on Balloons, put your cursor on the menu item and get a short explanation.

Microsoft Word Help: Open Word's Assistant and get a search box to type in. Word displays possible matches for you to read about.

Contents and Index: See an index of all topics available in Word's Help documentation.

Help on the Web: That's right! It is exactly what it sounds like. Select a link and a Microsoft help page is opened in your browser. If you are not online, Word will make the connection and then display the page.

Online Registration: If you have ever installed any software application on your computer you have seen those reminders to register the product online. Well, Microsoft keeps the reminder around in case you didn't register when you installed the software. Isn't that considerate of them!



Give the steps for opening the MS word.

7.3 Creating a Word Document

When Word opens, a new blank document called Document 1 appears on the screen, based on the Normal template. Template is a blueprint or pattern for all documents of a certain type, such as a letter, memo, or report. To begin working, just start typing. To create a new document with Normal template:

1. Choose the File >> New command or click the New button on the Standard toolbar.
2. The New dialog box appears with the Normal template selected.
3. Click OK, or press Enter.

Notes

Word's Normal Template (Normal. dot) Default Settings

Option	Default Setting
Paper size	Letter (8 1/2 inches x 11 inches)
Left and right margins	1.25 inches
Top and bottom document margins	1 inch Single
Line spacing	Align Left
Justification Tabs	0.5 inch
Font	Times New Roman
Point size	10 points
View	Normal

7.4 Editing in a Word Document

7.4.1 Typing in a Document

When you first create a document by using the Normal.dot template, the insertion point rests at the top of the document, ready for you to begin typing. To add text to a document, just start typing. By default, Word will automatically wrap your text to the next line when the text reaches the right margin. The only time you need to press Enter is when you want Word to create a new paragraph.



Task

With a new document on your screen, type in the following sentence about the Golden Hour Center.

Type: The Golden Hour Senior Citizen's center center center center center center center (that's right, seven centers) is a great place to relax, meet old and new friends, and get training on computers and word processing.



Task

How to insert picture from any other place into the MS word document?

7.4.2 Displaying Nonprinting Characters

Show/Hide button, on the Standard toolbar displays nonprinting characters, characters that can be displayed on-screen but do not print. Displaying nonprinting characters is a good idea because you can see at a glance whether you have typed an extra space or pressed Enter accidentally. Common nonprinting characters and their names are:

- Line break or new line (¶)
- Paragraph mark (¶)
- Space (·)
- Tab (->)

7.4.3 Moving Around in a Document

Notes

To make changes and corrections quickly and easily, various ways of moving around document are available.



You cannot have the cursor passed the end of the document using either the Arrows or the mouse.

7.4.3.1 Moving the Insertion Point

Keyboard Shortcuts for Moving Around in Document

Key(s)	Action
⇐	Moves the insertion point one character to the left.
⇒	Moves the insertion point one character to the right.
↑	Moves the insertion point up one line.
↓	Moves the insertion point down one line.
Home	Moves the insertion point to the beginning of the line.
End	Moves the insertion point to the end of the line.
Pg Up	Moves the insertion point up one window or page.
Pg Dn	Moves the insertion point down one window or page.
Ctrl + Home	Moves the insertion point to the beginning of the document.
Ctrl +End	Moves the insertion point to the end of the document. Ctrl + E—Moves the insertion point one word to the left.
Ctrl+*	Moves the insertion point one word to the right.
Ctrl+T	Moves the insertion point up one paragraph.
Ctrl+1	Moves the insertion point down one paragraph.
Ctrl+Pg Up	Moves the insertion point to the top of the previous page.
Ctrl +Pg Dn	Moves the insertion point to the top of the next page.

7.4.3.2 Scrolling Through a Document

Methods of scrolling by using the mouse or keyboard

Methods	Mouse Action	Key
Scroll up one line	Click the up-arrow key of V.scroll bar	
Scroll down one line	Click the down-arrow key of V.scroll bar	J,
Scroll up one screen	Click above the scroll box in the scroll bar	Pg Up

Notes	Scroll down one screen	Click below the scroll box in the scroll bar	Pg Dn
	Scroll left	Click the left-arrow key of H. scroll bar	E←
	Scroll right	Click the right-arrow key of H. scroll bar	
	Move to any specific location horizontally or vertically	Drag the scroll box	Not available

7.4.4 Using Go To Command

The Edit >> Go To command lets the user move the insertion point anywhere in the document. One can go to just about any location: sections, lines, footnotes, annotations, graphics, and tables. Refer to the following dialog box.

Figure 7.4: Use of Go To Command in Microsoft Word

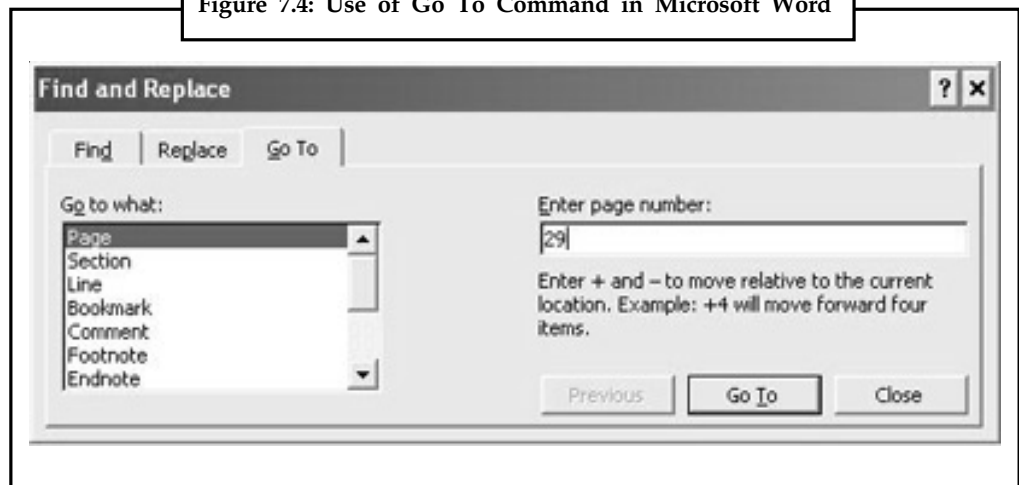

7.4.5 Manipulating Windows

Arrange All

- To open and work with a new document window, choose File » New and then Window >> Arrange All.
- It helps to work in a different view in each pane.

Active Window

- When the screen contains multiple documents, Word defines one document as the active document or active window.
- Select a window as active by simply clicking on any portion of the window.

Splitting a Window

Word lets you view different parts of a document at the same time by splitting the window into two panes. Figure below shows a split document window. Splitting a document window

can make navigating and editing of long documents easier. Changes made in one pane are reflected in the other.

Notes

To split a document, choose any of the following methods:

- Double-click the split box at the top of the vertical scroll bar.
- Choose Window » Split.

To remove the split, choose any of the following options:

- Double-click the split box.
- Choose Window » Remove Split.



Notes

A window can't be split when the Document Map or thumbnails are being displayed.

Figure 7.5: Splitting of Window in Microsoft Word

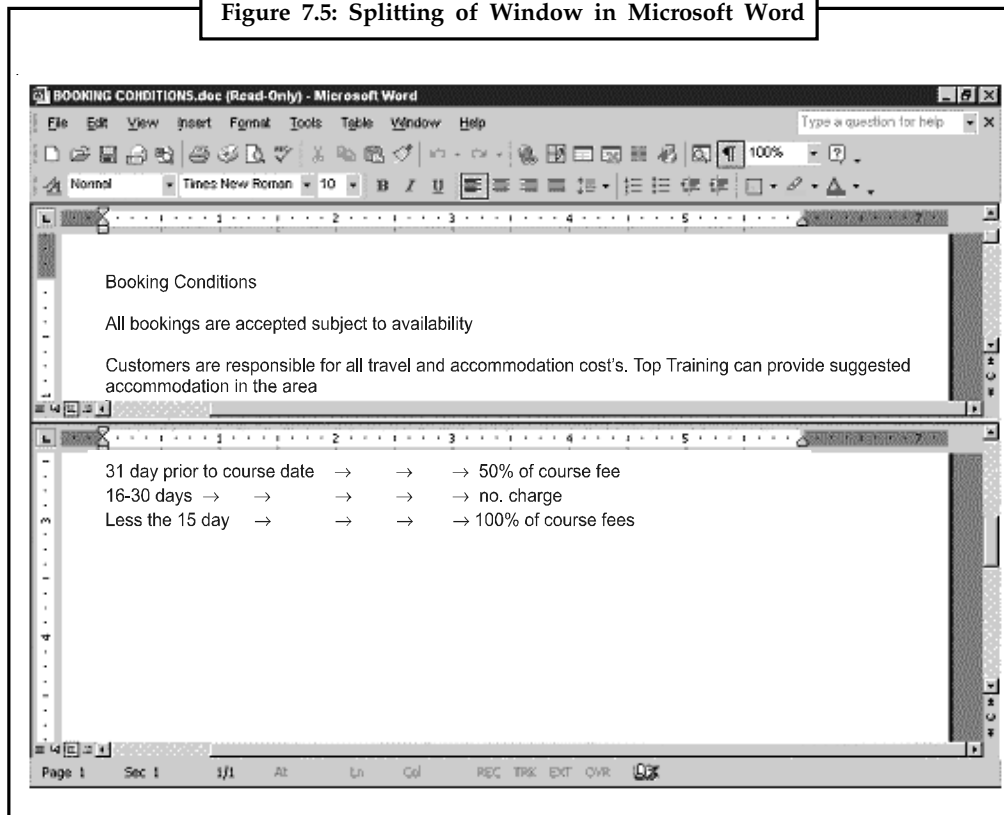

7.4.6 Selecting Text

Before moving, copying, deleting, or making changes in the text, the first step is to select the item. The general rule is to select first and then perform any action. This rule applies to nearly every action performed in Word.

Notes

Using the Mouse

To Select

Do This

A word

Double-click the word.

A graphics

Click the graphic.

A line of text

Click in the selection bar to the left of the line

Multiple lines of text

Click in the selection bar in the direction of the lines you want to select.

A sentence

Hold on Ctrl, and click in the sentence you want to select.

A paragraph
the paragraph.

Double-click in the selection bar to the left of

Multiple paragraphs Drag in the selection bar in the direction of the paragraphs you want to select.

Any item or amount of text Click where you want the selection to begin. Then hold down Shift, and click where you want the selection to end.

An entire document

Triple-click in the selection bar.

A vertical block of text

Hold down Alt, click the mouse button, and drag.

With the Keyboard

To Select

Press

One character to the right

Shift + right-arrow key

One character to the left

Shift + left-arrow key

To the end of a word

Ctrl + Shift + right-arrow key

To the beginning of a word

Ctrl + Shift + left-arrow key

To the end of a line

Shift + End

To the beginning of a line

Shift + Home

To the end of the document

Ctrl + Shift + End

The whole document

Ctrl + A

7.4.7 Editing Text

When you type in the text, you are quite likely to make mistakes. Corrections of these mistakes are called "editing". Editing text is an essential feature of a word processing package. Word makes it easy to add a new thought, change a word, or replace one phrase with another.

Inserting Text

Notes

Word normally works in the insert mode. The insertion point always stays within the workspace. Word shifts the existing text to the right to make room for the new text being inserted in the line. When it reaches the end of the line, Word automatically wraps the text, eliminating the need to press the Enter key until the user wants to start a new paragraph. Position cursor at desired location and start typing.



Notes

Before inserting text, switch to overtype mode by double-clicking OVR on the status bar or by pressing the Insert key.

Replacing Text

If you plan to replace text, select the text to be replaced. Type in the new text (it does not matter if the quantity of the new text is more or less than the old text).

Deleting Text

Below are the Word's keyboard deletion options. Selected text can also be deleted using Edit > > Clear command.

To Delete	Press
Selected text	Backspace or Delete
Character before the insertion point	Backspace
Character after the insertion point	Delete
A word before the insertion point	Ctrl + Backspace
A word after the insertion point	Ctrl + Delete



Caution

A common source of confusion for users is understanding the difference between the "Delete" key and the "Backspace" key. Put simply, the "Backspace" key deletes words to the LEFT of the cursor, and the "Delete" key deletes words to the RIGHT of the cursor.

Undoing Actions

The **Undo** command is used to reverse actions. You can undo an Undo with the help of Redo command. Word provides three methods to undo or redo the most recent action:

- Clicking the Undo button or Redo button on the Standard toolbar,
- Choosing Undo or Redo from the Edit menu
- Pressing the shortcut keys Ctrl + Z (Undo) or Ctrl+Y (Redo)

To undo or redo multiple actions, first click the arrow beside either the Undo or Redo button to display a list of actions and then select or click the desired action.

The Clipboard

The clipboard is a temporary storage area maintained by Windows. Applications can put data into the clipboard and recall it later. In fact, one application may put its data into the clipboard and another application may read this data. This is a convenient interface to

Notes

transfer data from one application to another. For example, we may copy data “letters finds” from DOC1 into the clipboard, then switch to Word and paste the data from the clipboard into the document DOC2.

Moving and Copying Text

Word supports all the usual Windows techniques for copying and moving information. It provides a feature called drag-and-drop, a handy one step, mouse-assisted move to take information from one place to another on the same page. Cutting removes the original selection from the document. Copying makes a copy of the selected text and leaves the original selection unchanged.

Smart cutting and Pasting

When cut or paste operations are carried out, Word adjusts the spaces remaining in the sentence. To deactivate the Smart Cut and Paste feature, Choose Tools >> Options, select Edit tab, and clear the Use Smart Cut and Paste check box.

Drag-And-Drop Editing

This feature is especially convenient for copying and moving text, where the source and destination are visible in the same screen.

To move or copy text by using drag-and-drop editing between Windows:

- Select the desired text.
- Do one of the following:
 - To **move** a selection, point to the selection, and hold down the mouse button until it becomes drag-and-drop pointer.
 - To **copy** a selection, hold down the Ctrl key, point to the selection, and hold down the mouse pointer until it becomes drag-and-drop pointer.
- Drag the pointer to the new location.
- Release the mouse button to drop the text into place.

Using the Cut, Copy, and Paste Buttons

Use the Cut, Copy, and Paste buttons on the Standard toolbar to move or copy text or graphics within a document, among different documents, or among other applications. To move or copy text and graphics with Standard toolbar

- Select the text to move or copy.
- Do one of the following:
 - ❖ To move the selection, click the Cut button on the Standard toolbar.
 - ❖ To copy the selection, click the Copy button on the Standard toolbar.
- Position the insertion point at the new location.
- Click the Paste button.

Using Commands and Keyboard Shortcuts

To copy a selection, choose Edit >> Copy, move the insertion point at the new location, and choose Edit >> Paste. To move a selection, choose Edit >> Cut and after specifying the location choose Edit » Paste.

Keyboard Shortcuts for Copying and Moving

Notes

To Do This	Press
Copy selected text to the clipboard	Ctrl + C
Move selected text to the clipboard	Ctrl + X
Paste clipboard contents in a document	Ctrl + V

7.5 Saving a Document

Click the Save button, or choose File >> Save. The Save As dialog box appears. By default, the File name text box lists the first sentence of the document.

Enter a name of up to 255 characters for the file. A filename can contain letters, numbers, and spaces, as well as the following symbols:

!, @, #, \$, %, &, (,), [, \, ^, _ , {, }.

Word automatically adds the filename extension .doc to the filename. Choose OK, or press Enter to save the document.

7.5.1 The Save Options: Fast Save or Full Save

The Save As dialog box includes an Options button. Clicking the Options button is same as choosing the Tools > > Options and then clicking the Save tab.

Save tab displays different options to save a file. The two most important save option are:

- Allow fast saves
- Always create back-up copy

Figure 7.6: Options of Fast Save or Full Save

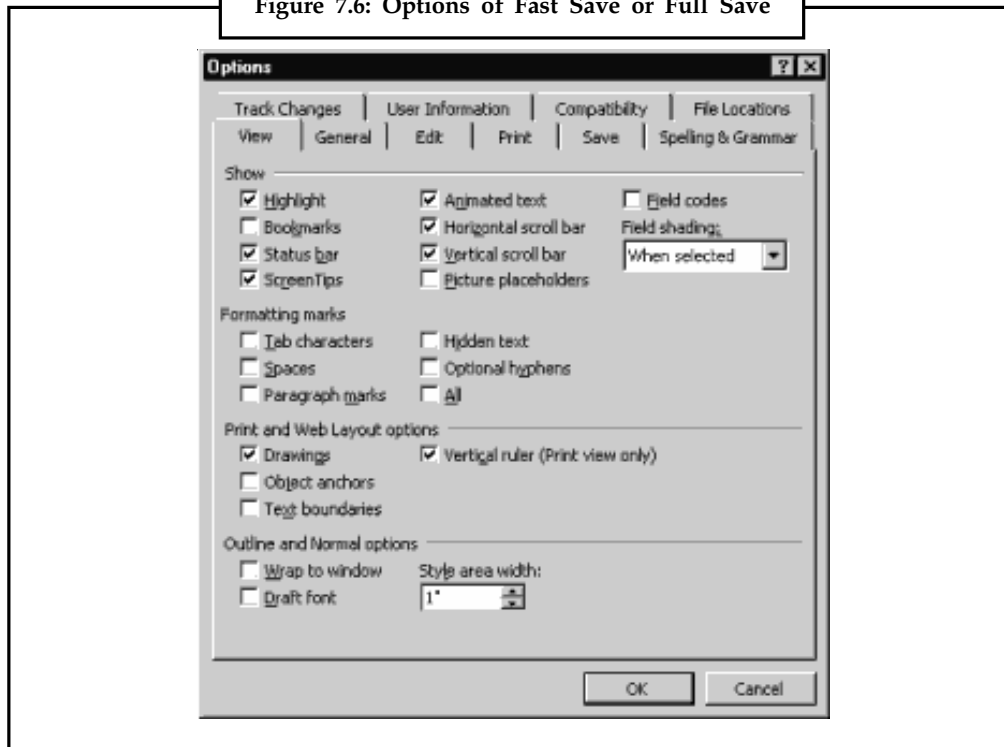

Notes

These two options are mutually exclusive. The Allow fast saves check box instructs Word to save only the changes to a document. This is faster than a full save, in which Word saves the complete, revised document.

7.5.2 Saving a File With a New Name

There are several reasons to save a file with a different name:

- To track modification made by others.
- To save a copy in a different folder than the original.
- To make changes to the original document but also keep the original intact in order to compare the different versions.
- To save the file in a different format so another application can use it. To save a document with a new name:
- Choose File >> Save As. The Save As dialog box appears. Type the new name in the File Name box.
- Select the appropriate drive, if you want to save it on a different location.
- Select the desired format by clicking the Save as Type box.
- Click Save or press Enter.

Figure 7.7: Saving of File with a New Name

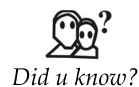
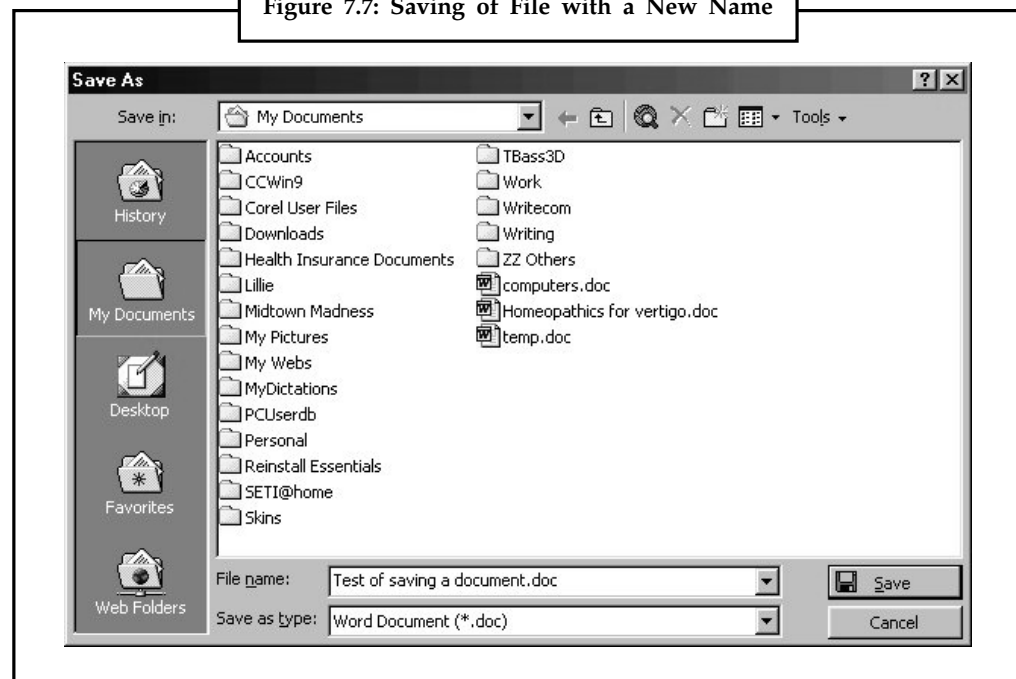

Word can protect your work by saving a temporary copy of a document periodically as you work. To set up this option, click the **Tools** menu and select **Options**; then select the **Save** tab. Click on the AutoRecover info every: field and then specify a time for how often you'd like this to occur. You still must use the **Save** command on the **File** menu to save the document normally when you finish working on it.

7.6 Printing Documents

Notes

Click the Print button in the Standard toolbar, the document goes directly to the printer. To specify what exactly has to be printed use the File << Print command to display Print dialog box.

Figure 7.8: Printing of Document in Microsoft Word

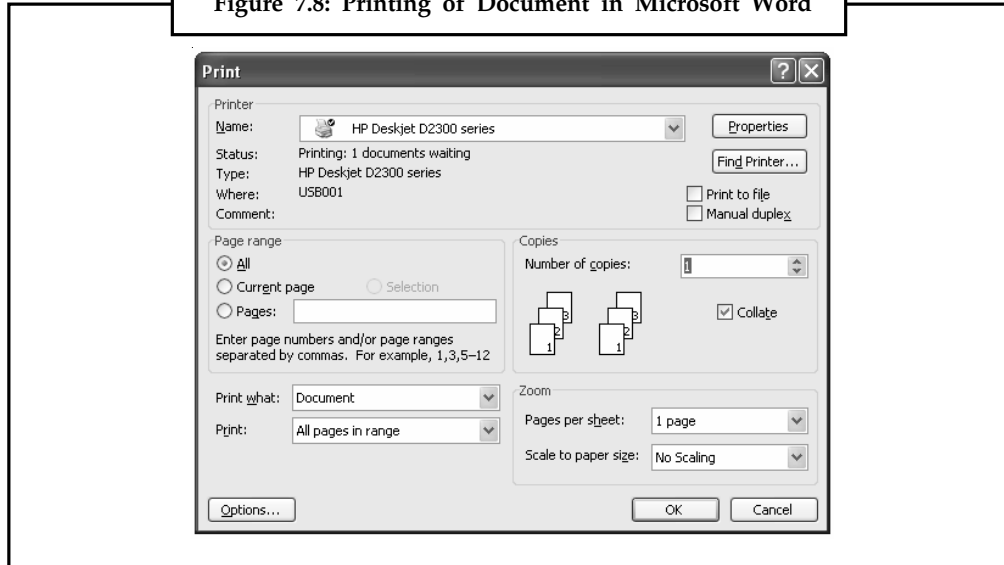

7.6.1 Using Print Preview before Printing

Print Preview command is used to view document in a variety of *ways*. To preview a document in Print Preview:

- Choose File >> Print Preview or click the Print Preview button on the Standard toolbar.
- To close Print Preview, choose the Close button.

Figure 7.9: Print Preview Toolbar

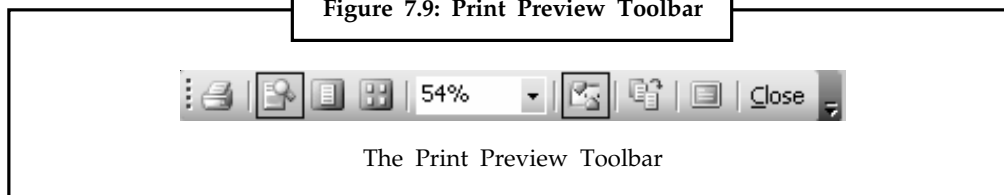

The Print Preview Toolbar

Button Name	Action
Print	Prints the document by using default print options.
Magnifier	Enlarges or reduces the document view.
One Page	Displays the document in single-page view.
Multiple Page	Views one or more pages of a document.
Zoom Control	Select different magnifications, from 10 to 500 percent and other options.
View Ruler	Displays or hides the horizontal and vertical rulers.

Notes	Shrink to Fit document	Shrinks document to fit on one page or less if the last page of contains only a few lines of text.
	Full Screen	Removes title bar and toolbars to show a full screen display of the document in Print Preview.
	Close Preview	Closes Print Preview and returns to your document.
	Context Sensitive	Provides Context-Sensitive Help for Print Preview Help options.

7.7 Exiting Word

Use one of the following five methods to correctly exit Word.

- Choose the File » Exit command.
- Press Alt+F4.
- Click the Close button in the right corner of the Word program title bar.
- Double-click the control menu icon in the left corner of the Word program title bar.
- Right-click in the Microsoft Word button in the taskbar, and choose Close from the pop-up menu.

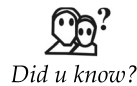

As with most Windows programs, MS Word will take care of your files when you Exit or Close. If you have open files with unsaved changes, Word will prompt you to save or abandon the changes in each file that was open before actually exiting.

7.8 Opening a Document

- Choose File >> Open to display Open dialog box.
- Select the appropriate drive and folder, using Look In combo box.

Figure 7.10: Opening a File in the Microsoft Word

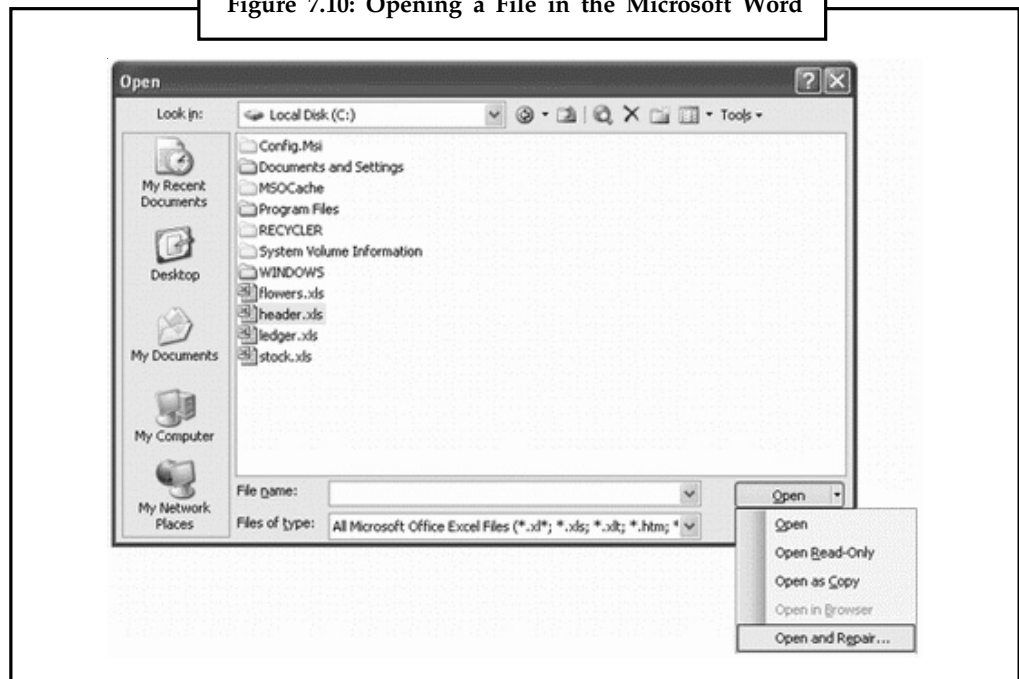

- Select the file on which you want to work.
- Click on Open button or press Enter.

Notes

7.9 Finding Files

The Find Files feature is a part of Open dialog box, and works by searching for a filename or specific words or phrases in the document. Searching of a file(s) can be done by filename, text or date of last modification. Searching can also be done by using the advanced button in the Open dialog box.

7.10 Word's Document Views

Word lets the user view documents from a number of different perspectives to make them easier to visualize and quicker to work with. These display options are called views. Word provides the following views Normal, Outline, Print Layout, Web Layout, and Print preview. To change the view either use View menu or View buttons on the horizontal scroll bar.



Changing the size of the margins can reformat complete document or part of text.

7.10.1 Normal View

Normal view is the default view. It is not a true WYSIWYG view because one cannot see headers and footers, footnotes and annotations but the formatting and layout elements of the document can be seen. Working with this view is relatively speedy. You should work in Normal view to type, edit, and format text.

7.10.2 Print Layout View

Print Layout view should be used to see how text, graphics, and other elements will be positioned on the printed page. This view is useful for editing headers and footers, for adjusting margins, and for working with columns and drawing objects.

7.10.3 Outline View

Outline view is a specialized view that one can use to organize a document. In Outline view, you can expand or collapse portions of the document to see only the headings of your choice. You can quickly and easily move and copy large portions of the document in Outline view.

All paragraphs even your heading paragraphs appear in Outline view as body text paragraphs. But you can promote any body text paragraph to any level of heading that you want, and you can demote a heading to body text. In Outline view, you can collapse a document to see only the main headings, or you can expand it to see all headings and even body text.

7.10.4 Web Layout View

Web Layout view should be used when you are creating a Web page or a document that is viewed on the screen. In Web Layout view, you can see backgrounds, text is wrapped to fit the window, and graphics are positioned just as they are in a Web browser.

Notes

7.10.5 Full Screen View

Use the Full Screen view to hide all of Word's menus, toolbars, and rulers and have the whole screen to write. On selecting View >> Full Screen, nothing is displayed on the screen except the document and the one-button toolbar. To return to the previous view, click once on the button or press Esc.

7.10.6 Web Page Preview

In Web page preview, you can see how your document will look in a Web browser. Microsoft Word saves a copy of your document and then opens it in your default browser. If your Web browser is not already running, Word starts it automatically. You can return to your document in Word any time.

7.10.7 Print Preview

In print preview, you can display multiple pages of a document reduced in size. In this view, you can see page breaks, hidden text, and watermarks, and you can make editing or formatting changes before you print the document.

7.10.8 Zoom

Zooming changes the magnification of the document. The default is 100 percent. User can zoom up to 500 percent. Highes zooms are good for overall design checking and lower zooms are good for detail checking.



Notes

Each view can have a different zoom level.



Case Study

History of Microsoft Word

Microsoft Word is a well known word processing software developed by Microsoft. Microsoft Word or Microsoft Office Word was initially released in 1983. It was meant for the XENIX systems in the beginning. But as it grew, Microsoft Word was rewritten so it can support several other platforms such as DOS, Macintosh, UNIX, OS/2, and Windows. In 2003, Microsoft Word became part of the Microsoft's complete office suite software known as the Microsoft Office. Thus the name 'Microsoft Word' officially changed to 'Microsoft Office Word'.

Microsoft Word Version Release History

1983

- Word 1 for MS-DOS

1985

- Word 2 for MS-DOS

Contd...

- Word 1 for Macintosh

1986

- Word 3 for MS-DOS

1987

- Word 4 for MS-DOS (Titled Microsoft Word 4.0 for the PC)

- Word 3 for Macintosh

1989

- Word 5 for MS-DOS

- Word 4 for Macintosh

- Word for Windows 1.0. (code name 'Opus')

1990

- Word for Windows 1.1 (code name 'Bill the Cat')

- Word for Windows 3.1

1991

- Word 5.1 for MS-DOS

- Word 5 for Macintosh

- Word for Windows 2.0 (code name 'Spaceman Spiff')

1992

- Word for OS/2 version 1.1B

1993

- Word 6.0 for MS-DOS

- Word 6 for Macintosh

- Word for Windows 6.0 (code name 'T3')

1995

- Word for Windows 95

1997

- Word for Windows 97

1998

- Word 98 for Macintosh

Contd...

Notes

1999

- Word 2000 for Windows

2000

- Word 2001 for Macintosh

2001

- Word 2002 for Windows
- Word v.X for Macintosh (only for Mac OS version X)

2003

- Word 2003 for Windows. Officially named Microsoft Office Word 2003. Also known as Word 11.

2004

- Word 2004 for Macintosh

2006

- Microsoft Office Word 2007. Also known as Word 12

Questions:

1. Give the name and year of first Microsoft Word Version.
2. Give the latest version of MS word.

7.11 Summary

- Word is a word processor, created by Microsoft Corporation, US.
- The word screen contains the title bar, Menu bar, Toolbars, Ruler and etc.
- Microsoft word 2000 is a word Proceeding program designed for windows 98 and window NT 4.0 and later.
- World 2007 presents a new user interface which is quite different than previous of word.
- The word's document views contains normal views, outline, print layout, web layout and print preview.

7.12 Keywords

Backspace: Remove characters to the LEFT of the insertion point.

Delete: Remove characters to the RIGHT of the insertion point.

Insertion Point: In graphics-based programs, the insertion point is the point where the next characters typed from the keyboard will appear on the display screen. A blinking vertical line usually represents the insertion point. You can reposition the insertion point by pressing the arrow keys or by moving the I-beam pointer.

Mail Merge Tool: Word's Mail Merge feature allows you to quickly create personalized correspondence and other documents by combining (merging) information from two different files.

Menu Bar: A horizontal menu that appears on top of a window. Usually, each option in a menu bar is associated with a pull-down menu.

Office Assistant: The Office Assistant is a "character" or a "virtual person" whose main job is to provide instant help when using a Microsoft Office product.

Tab: A key on computer keyboards that inserts a tab character or moves the insertion point to the next tab stop. Some applications respond to the tab key by inserting spaces up to the next tab stop. This is often called a soft tab, whereas a real tab character is called a hard tab.



Lab Exercise

1. How to add the clips art in the document?
2. How to make more copy of the same documents?

7.13 Self-Assessment Questions

1. Word processing is by far the most widely used computer application.
 - (a) True
 - (b) False
2. Lower zooms are good for detail checking.
 - (a) True
 - (b) False
3. It is possible to save an existing file with a different name.
 - (a) True
 - (b) False
4. Using Word you can search a file by specifying the text it contains more than one document window can be made active at one time.
 - (a) True
 - (b) False
5. Default magnification is 75 percent.
 - (a) True
 - (b) False
6. While working in Ms-Word you have to work with
 - (a) Mouse only
 - (b) Keyboard only
 - (c) Both mouse and keyboard
 - (d) None of these

Notes

7. In Ms-Word every command is available in
 - (a) Print
 - (b) Letter
 - (c) Icons
 - (d) None of these
8. You can go inside Ms-Word by the following way
 - (a) Take the mouse pointer to START button on the task bar and click the left mouse button.
 - (b) Take the mouse pointer to START button and click the right mouse button.
 - (c) Move the mouse pointer on the screen.
 - (d) All of these

7.14 Review Questions

1. What are the advantages of using a Word processor?
2. What are the specific features of Word 2000?
3. List the various requirements for running Word 2000.
4. What are the various parts of the Word screen?
5. Explain the various buttons displayed in the Preview window.
6. Briefly explain the use of Formatting toolbar in Word.
7. What is the function of the status bar in the Word? List down the information that is displayed in the status bar.
8. What are the various views available to see a document in Word?
9. How do you make a template? What is a template? What is Normal.dot?
10. How will you change the default font from Times Roman New 10pt (12pt) to something else?
11. How do you type roman numerals on Microsoft Word?
12. What are some common errors that people make using Word?
13. What do you understand by Word processing? Give examples.
14. Describe the important features of Ms-Word.
15. Describe the various options available in the main menu bar of Ms-Word.
16. What are the different types of toolbar?
17. Define two methods to start Ms-Word.

Answers for Self-Assessment Questions

- | | | | |
|--------|--------|--------|--------|
| 1. (a) | 2. (b) | 3. (a) | 4. (a) |
| 5. (a) | 6. (c) | 7. (c) | 8. (b) |

7.15 Further Reading

Notes



Fundamental Computer Skills, Feng-Qi Lai, David R. Hofmeister



<http://books.google.co.in/bkshp?hl=en>

Unit 8: Microsoft Word-II

CONTENTS

Objectives

Introduction

8.1. Finding and Replacing Text

8.1.1 Find Command

8.1.2 Replace Command

8.1.3 Options for Search Criteria

8.2. Proofing Documents

8.3. Bullets and Numbering

8.4. Header and Footer

8.5. Working with Table

8.5.1 Designing Tables

8.5.2 Table Headings

8.5.3 Selecting Table Elements

8.5.4 Working with Rows and Columns

8.5.5 Positioning Your Table

8.5.6 Working with Table Borders

8.5.7 Images in Tables

8.6. Collecting Spelling Errors

8.6.1 Spelling Error Options

8.7. Quick Spelling Checking

8.8. Using Automatic Spell-Check

8.9. Using the Grammar Command

8.9.1 Document Statistics and Readability Estimates

8.10. Using the Synonyms Thesaurus

8.11. Using AutoCorrect and AutoText

8.11.1 Creating AutoCorrect Entries

8.11.2 Inserting AutoText Entries

8.11.3 Using the AutoComplete

8.12. Hyphenating Documents

8.13. Summary

8.14. Keywords

8.15. Self-Assessment Questions

8.16. Review Questions

8.17. Further Reading

Objectives

Notes

After studying this unit, you will be able to:

- Discussed finding and replacing the text in MS word.
- Explain proofing of documents and working with tables.
- Discussed about collecting of various spelling errors as will as the quick spelling errors.
- Discussed synonyms thesaurus and hyphenating documents
- Explain the using and creating, insertion of Auto correct and Auto text.

Introduction

The most basic function of MS Word is to create a document/file. Once a document has been created, the user may enter data—for example by typing some text. At any point after the document has been created, the user is allowed to save the contents. The document can then be accessed at a later time and modified as necessary. Documents can be printed out at any stage in this process.

8.1 Finding and Replacing Text

The Find and Replace option of Word is a convenient way of searching for a particular word in a document and replacing it with another. It can be used in situations where an error (not an error in spelling) has been committed consistently in a document and has to be corrected.

The **Find** command moves to a specific point in the document quickly and the **Replace** command searches for and replaces the text.

8.1.1 Find Command

- Choose Edit >> Find or click the Select Browse Object button in the vertical scroll bar and click the Find icon.
- Enter the text to be searched in the Find What text box.
- Specify Search option and other check options if required.
- Choose Find Next. Word begins the search and highlights the first occurrence of the text it was searching.



Notes

If you also want to replace the text, type the replacement text in the **Replace with** box.

Figure 8.1: Find and Replace Windows

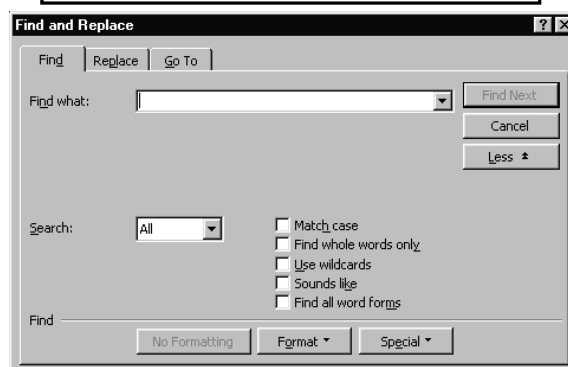

Notes

8.1.2 Replace Command

The Replace command, like the Find command, also finds specific text. It automatically replaces each occurrence of the text being searched with the replacement text. To search and replace text in, a document:

- Choose Edit >> Replace.
- Enter the text to search for in the Find What text box.
- Choose all, Up or Down Search option.
- In the Replace With text box, enter the replacement text.
- Do one of the following:
 - To confirm each replacement, choose find next. Then choose replace to replace the text or Find next to skip to the next occurrence.
 - To change all occurrence of the search text without confirmation, choose Replace All.
- Choose Close to end the replace session.

Figure 8.2: Replace Command

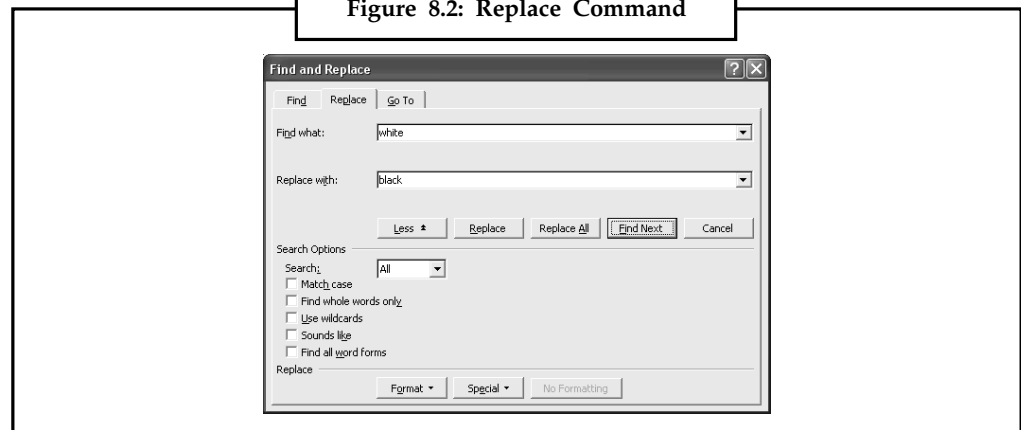

8.1.3 Options for Search Criteria

Select one or more options for of Find and Replace dialoge box explained below.

- **Match case:** Find only the text that matches the uppercase and lowercase Letter of search text.



Did u know?

If the **Match case** check box is selected, Office Word searches only for words that match the case of the word or phrase that you typed in the **Find what** box. For example, if you search for **AKA**, the result includes **AKA** but not **aka**

- **Find whole word only:** Restrict the search ro entire words that match the Sepecified search text.
- **Use wildcard:** Allow to specify wild card symbols in search text.
- **Sound like:** Used to find different spelling of word that sound similar.

- **Find all word forms:** Find different grammatical version of a specified word.
- **Search:** Controls the direction of the search beginning at the insertion point. The default direction is All. It also includes two other search options: Up and Down.

Notes



Task

Make a document and search any name and replace the another name.

8.2 Proofing Documents

One of the many useful features of word is that it can automatically check out document for spelling mistake. It has a built in English language dictionary. This dictionary is stored in the hard disk of the computer and it contains commonly used words in the English language.

Word has a Spelling-Checker and Grammar-Checker programs to check documents for misspelled word, duplicate words, grammar, style, punctuation, and word usage. These programs also offers advice to fix potential problems. The automatic checking features catch the misspelled words and other errors immediately.



Notes

Not all language grammar proofing files auto-register after you copy the grammar files to a specific location. Therefore, it is always advisable to use the Setup program to install the grammar proofing files (and other proofing tools).

8.3 Bullets and Numbering

Bullets are used to set-off and emphasize sections of text and are symbols such as dots or diamonds.

The numbering feature also acts like the bullets only that it use the number instead of symbol to represent.

Uses of bullets and numbering

- Break the long sentence into points form.
- Enhance readability and credibility.

Grab attention and highlight important points.

Then, here I let you know how to apply bullet or numbering in Microsoft Word.



Did u know?

The best way to end a list is to click either **Body Text** or **Normal** in the **Styles** box on the **Formatting** toolbar.

To apply default bullet formatting to a list

- Select the list you wish to apply number of bullet formatting to.
- Click on the Bullets icon on the Formatting toolbar.



Notes

If you use the built-in heading styles to format the headings in your document, you can automatically number the headings with the numbering format you choose.

Notes

To apply alternate bullet formatting to a list

- Select the text you want to add bullets to.
- From the Format menu, click Bullets and Numbering.
- From the Bullets and Numbering dialog box displayed, the Bulleted tab should be displayed, if not, select it.
- A list of different bulleted styles will appear, select a style that you like.
- Click on the **OK** button or press **Enter**.

Figure 8.3: Bullets and Numbering

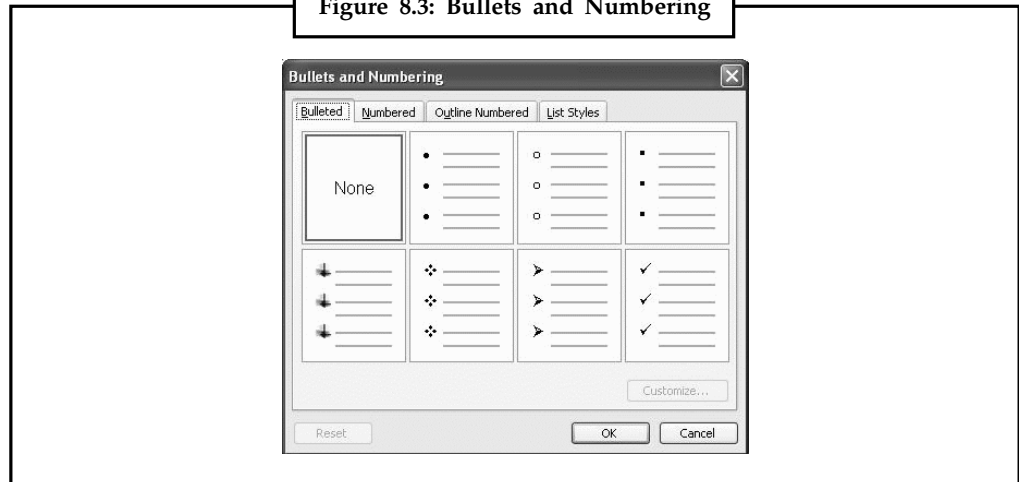

To remove bullet formatting from a list

- Select the list to which the bullet formatting has been applied.
- Click on the Bullets icon on the Formatting toolbar.

To add numbering to a list

- Select the text you wish to re-format as a numbered list.
- Click on the Numbering icon on the Formatting toolbar.

To add alternative numbering styles to a list

- Select the text you wish to re-format as a numbered list.
- From the Format menu, click Bullets and Numbering.
- From the Bullets and Numbering dialog box displayed, click on the Numbered tab.
- A list of different numbered styles displayed, select the numbering format that you require.
- Click on the **OK** button or press **Enter**.

To remove numbering from a list

- Select the list to which the bullet formatting has been applied.
- Click on the Numbering icon on the Formatting toolbar.

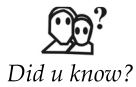

If you want to add a paragraph between items in a bulleted or numbered list, turn off bullets or numbering, type the text you want, and then turn bullets or numbering back on.

Notes

8.4 Header and Footer

Word Header and Footer allow you to insert information at the top or bottom of every page. This information normally consists of chapter headings, page number, etc.

You can see header and footer information on your screen when in Print Layout View and Print Preview, but not in the Normal view.

To create a header or footer

- From the View menu, click Header and Footer.
- Word changes to Print Layout view and the Header and Footer toolbar is displayed.
- Outlines of the Header and Footer text entry boxes appear at the top (header) and bottom (footer) of the page.

Figure 8.4: A Header or Footer

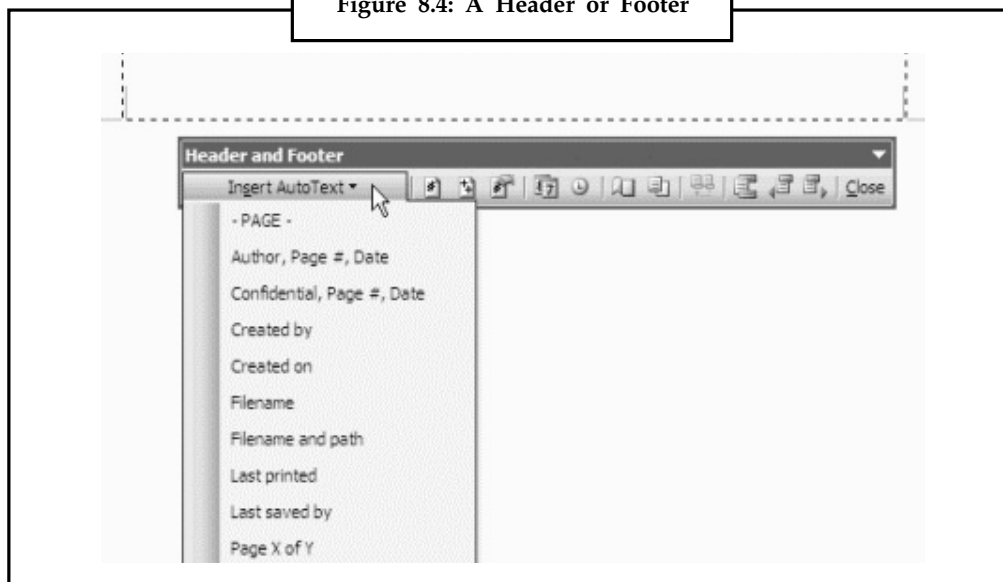

- Insert the text for the header or footer in the appropriate text entry box. You can just type any text that you like.
- You can change between header or footer by clicking on the Switch Between Header and Footer icon.
- You also can click on the appropriate Header and Footer toolbar icons to insert the page number, time, date, etc in the header or footer. The following options are available:

Icon	Function
Insert AutoText	Inserts the default auto text.
Insert Page Number	Inserts page number into the header or footer.

Notes	Insert Number of Pages	Inserts the total number of the document.
	Format Page Number	Format the page number.
	Insert Date	Inserts the current date.
	Insert Time	Inserts the current time.
	Page Setup	Opens the Page Setup dialog box.
	Show/Hide Document Text	Displays or hides document text.
	Same as Previous section, or new.	Section header/footers should be the same as the previous section, or new.
	Switch Between Header and Footer	Toggle between allowing you to edit the header and footer.
	Show Previous where	Shows the previous section header/footer (only useful where a document is made up of multiple sections).
	Show Next	Shows the next section header/footer (only useful where a document is made up of multiple sections).

When you have entered your header and footer text, click on the Close button on the Header and Footer toolbar.



Did u know?

Using the Date button will insert an updating date that will change to the current date each time you print.

To move text in the header or footer text entry box

- From the View menu, click Header and Footer.
- In the Header or Footer text entry box, press the Tab key on your keyboard to move the cursor to the middle or right hand side of the entry box.
- You also can use the Align Left, Right, Center, or Justify icons on the Formatting toolbar to do this.



Notes

The Header and Footer toolbars are identical in Word 97 and Word 2000.

8.5 Working with Table

Word tables provide a simple way to present information in a small space and in a readable format. After all, we're used to reading table data in everything from train timetables to bank statements. Tables are a key feature of Microsoft Word, which includes lots of tools that help you add functionality to your tables and work with them more effectively.

Figure 8.5: Table

Product Category	Country	Sum of Sales/Amount
Accessories	Australia	10,300.34
Accessories	Canada	103,377.85
Accessories	France	63,406.78
Accessories	Germany	62,232.59
Accessories	United Kingdom	76,630.04
Accessories	United States	256,422.07
Bikes	Australia	8,852,050.00
Bikes	Canada	1,821,302.39
Bikes	France	2,553,575.71
Bikes	Germany	2,808,514.35
Bikes	United Kingdom	3,282,842.66
Bikes	United States	8,999,859.53
Clothing	Australia	70,259.95
Clothing	Canada	53,164.62
Clothing	France	27,035.22
Clothing	Germany	23,565.40
Clothing	United Kingdom	32,239.51
Clothing	United States	133,507.91

8.5.1 Designing Tables

In Word, you can use the table drawing tools to edit it. With your table selected, click the **Tables and Borders** button on the Standard toolbar to display the Tables and Borders toolbar. To add lines to your table, click the **Draw Table** button and draw horizontal and vertical lines to split table cells in two or draw diagonal lines across a cell. To join two or more cells to make one large cell select the **Eraser** tool and draw across the line between the cells.



Notes

To manually change the width of a table or column after you've created it, use the mouse to place the pointer over the vertical line you want to move. When the pointer turns into a double-headed arrow, drag the line to the position you want it in the table.

8.5.2 Table Headings

When you have a table with lots of narrow columns, it can be difficult to use long headings because they don't display properly. The Tables and Borders toolbar includes a Change Text Direction button which lets you rotate the text in a cell so that it appears either horizontal or in one of two vertical directions. Choose one of the vertical options to rotate even very long column headings to fit a narrow column width.

If a table consumes more than one page of your document it is useful to have the table headings repeated at the top of the second and subsequent pages so you can read the headings once you print the document. To do this, select the table rows that comprise the

Notes

table headings and choose **Table > Heading Rows Repeat**. Now the selected rows appear at the top of the table on each subsequent page.

Figure 8.6: Table Headings

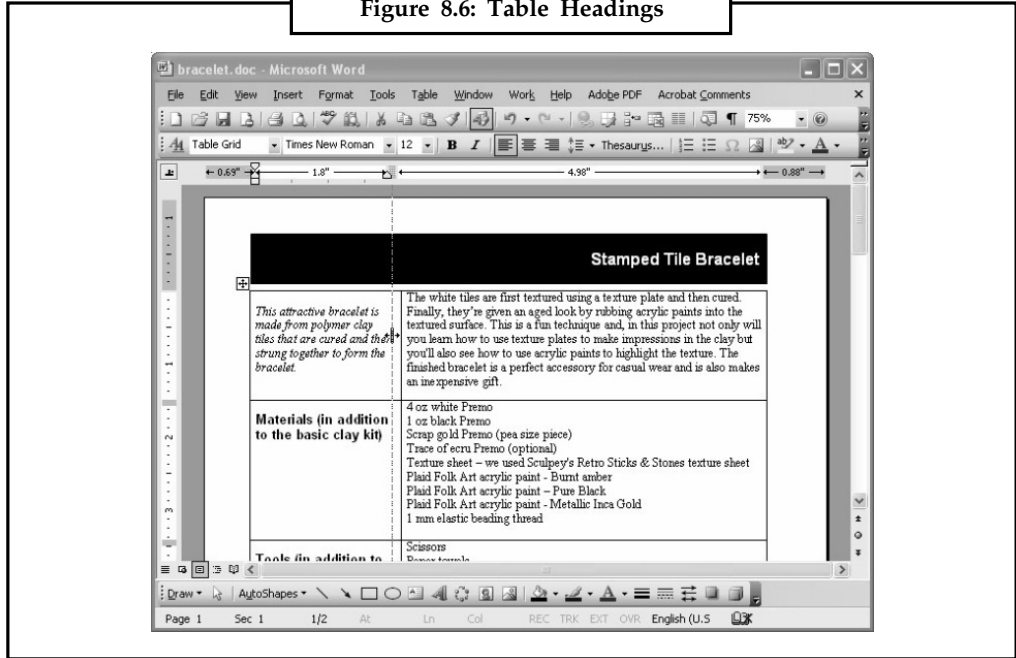

8.5.3 Selecting Table Elements

Some table options work differently depending on whether a cell is selected or not. For example, if you have a cell selected and you adjust the divider between it and the next cell only this one cell's divider moves and not the border for the entire column. So, to adjust a column's width, make sure you haven't selected any cells before you drag its left hand border.

Figure 8.7: Selecting Table Elements

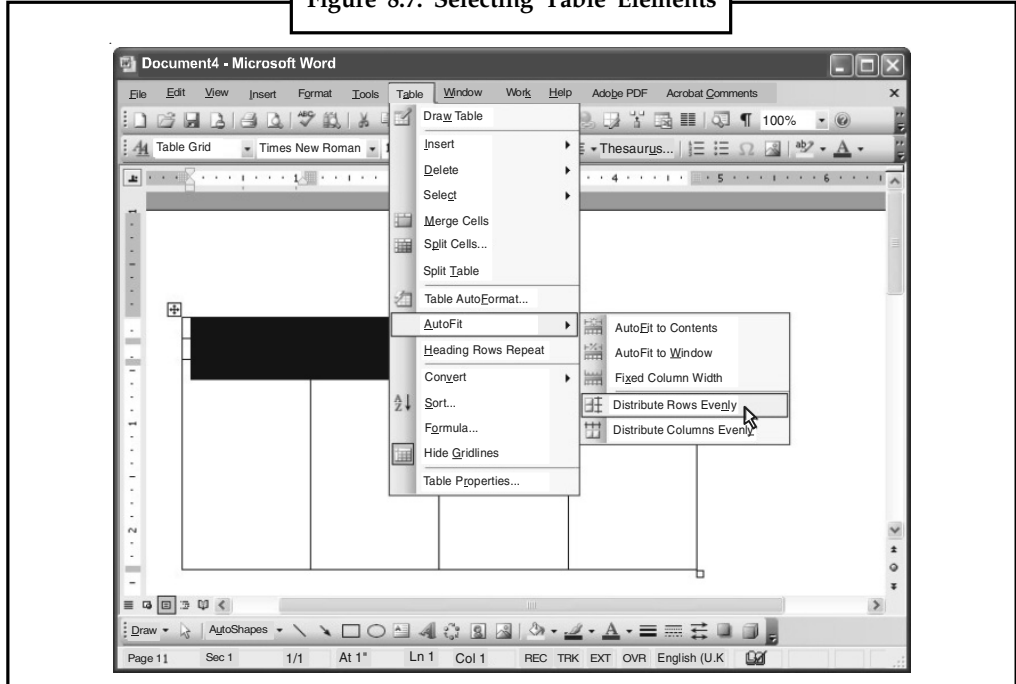

When you first begin working with tables, selecting what you need to work with can be difficult until you discover where to hold your mouse pointer. To select a cell, hold the mouse pointer over its bottom right corner until it changes to a black angled arrow, click once to select that cell or click-and-drag to select multiple cells.

To select a row, position the mouse pointer in the margin well to the left of the row until it shows as a large hollow arrow and click to select the row or click and drag to select multiple rows. To select an entire column, hold the mouse pointer above the top border of the column until it turns into a black down-pointing arrow and click once to select the column or click-and-drag to select adjacent columns.

To select the entire table, place the mouse pointer over the top left corner of the table until a small box with a double-headed arrow in it appears. Click this icon to select the table. With the table selected, you can drag to move the table or, to delete the table, press the **Backspace** key. It's helpful to note that pressing the Delete key deletes the table contents while leaving the table in place, and pressing the Backspace key deletes the entire table.

Figure 8.8: Selecting Elements

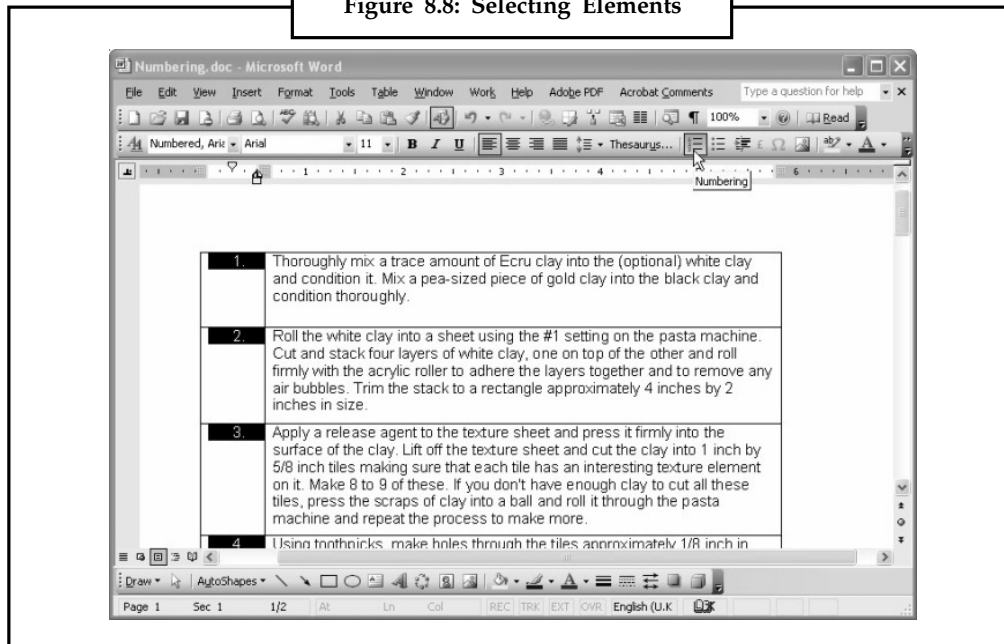

8.5.4 Working with Rows and Columns

To add a column to a table, click at the top of the table just to the right of the last cell where the mouse pointer shows as a black down-pointing arrow. This selects the invisible markers at the end of each table row and displays the **Insert Columns** button on the Standard toolbar. Click this button to add a column. To add a row to a table, click in its bottom right cell and hit the **Tab** key.

When adjusting the width of a column, you can read the column width from the ruler by holding the **Alt** key as you drag on the column's right border.

When you need a series of columns or rows to be the same height or width, first select the columns or rows to alter and drag the right-most or bottom border to the point where you want the table to extend. Now choose **Table > AutoFit > Distribute Rows Evenly** or

Notes

Distribute Columns Evenly and the table rows or columns will readjust accordingly to even widths or heights. This is much quicker than trying to set each column or row height individually.

Figure 8.9: Working with Rows and Columns

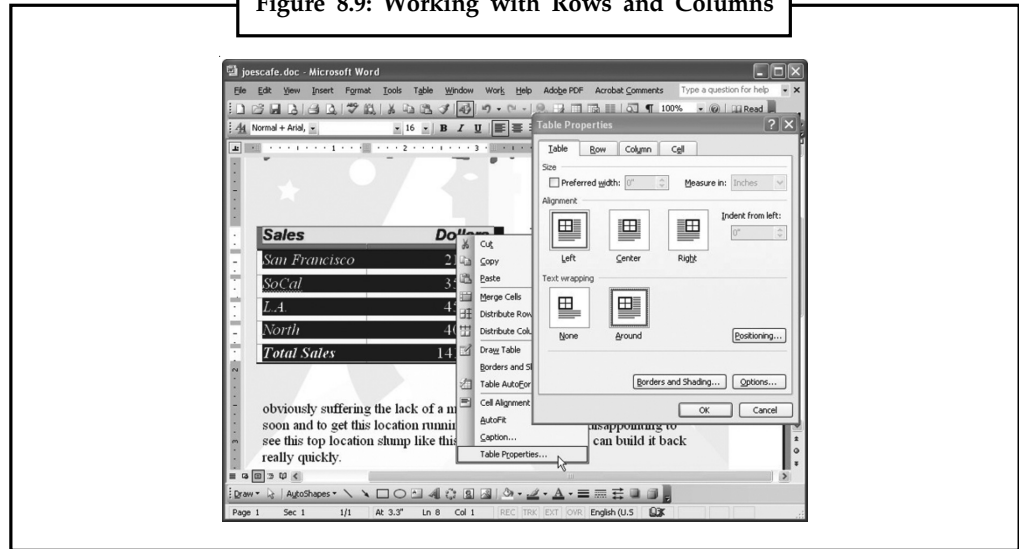

When you need to reorder the rows in the table, you can do so with a simple keystroke combination. Click in the row you want to move or select multiple rows and hold the **Shift + Alt** keys while you click the **Up** or **Down** arrow keys. This moves the selected row or rows up or down the table. If you move a table row to the bottom or top of the table and keep pressing, the row will split away from the table to form a second table.

When you need to number rows in a table, use the paragraph numbering tool. To do this, select the column that will hold the numbered cells and click the **Numbering** button on the Formatting toolbar. Numbers are automatically added to the cells and—if they contain content—the numbering appears before each cell entry. If you alter the position of a row in the table, the numbering readjusts automatically.

Figure 8.10: Numbering Readjusts

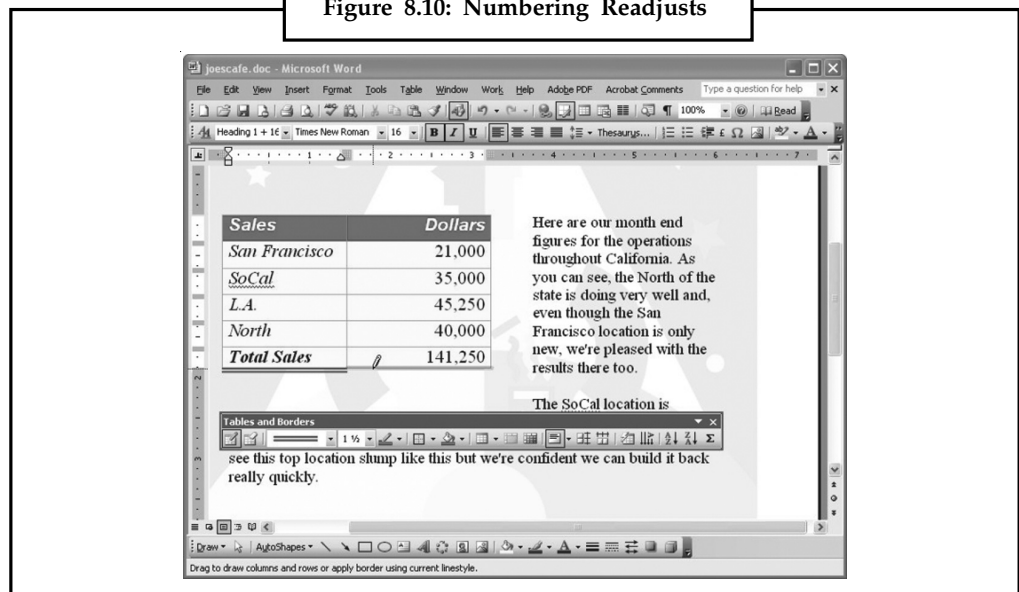

8.5.5 Positioning Your Table

When your table is not as wide as the page, you can adjust its positioning on the page and how text wraps around it. For example, to center the table between the left and right margins, select the table using the marker in its top left corner and choose **Table > Table Properties > Table tab**. Select the **Center** option and then select how text should wrap around the table. When you select the **Around** option, click the **Positioning** button to fine tune the text wrapping options as well as to configure the distance between the table and the surrounding text.

8.5.6 Working with Table Borders

To adjust the table borders, select the borders you want to work with or select the entire table and choose **Format > Borders and Shading > Borders tab**. Select the border options and, from the **Apply to list**, select either **Table** or **Cells** depending on what you want to format. Then click **OK** to apply the changes. If you find this dialog confusing (and it is a little), use the options on the **Tables and Borders toolbar** to select the line style and color you want and then use the **Draw Table** button to draw the desired line style onto the table.

Figure 8.11: Working with Table Borders

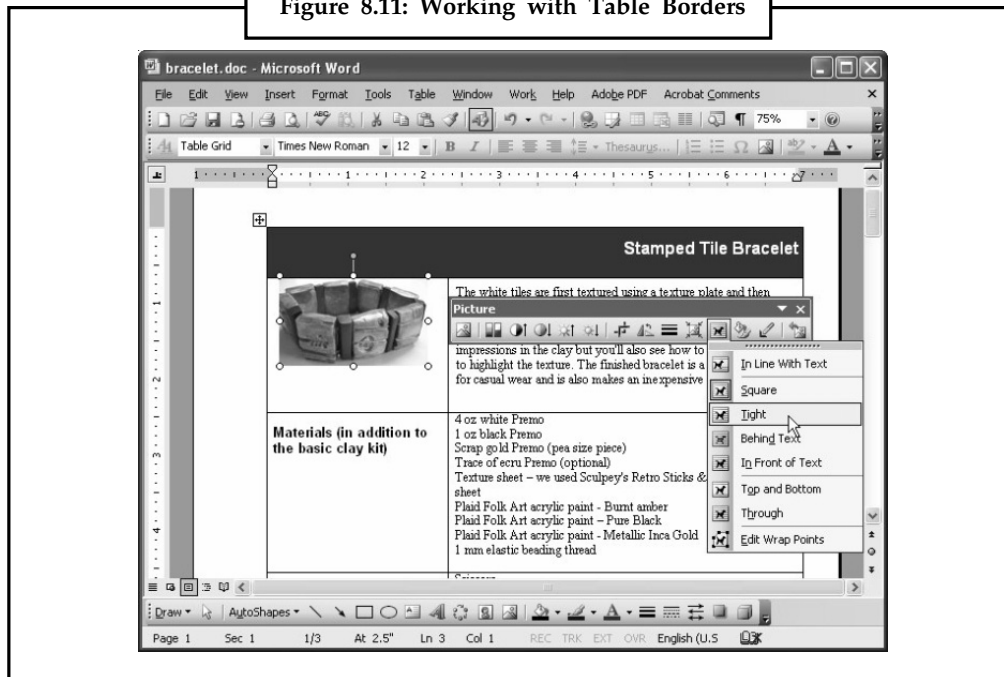

8.5.7 Images in Tables

When you are working with images in tables, you can constrain the image so it stays inside the table cell. To do this, click in the cell to place the image, choose **Insert > Picture** and then choose the **ClipArt** or **From File** option. Select the image to add to the table cell—by default it is added with the **In-line with text** layout. You can change this so that text in the table cell wraps around the image by choosing either the **Square**, **Tight**, **Through**, or **Top and Bottom** option from the **Text Wrapping** dropdown list. All these options constrain the image so it stays in the table cell. The options **Behind Text** and **In Front of Text** break the image out of the table so it either floats below or above it.

Notes



Did u know?

Tables are an extremely powerful feature in Microsoft Word.

8.6 Correcting Spelling Errors

The user can check the spelling of an entire document, a selection of text, or a single word. To run the spell-checker from the menu:

- Select the word or text to be checked. To check the entire document, make sure that nothing is selected.
- Choose Tools >> Spelling and Grammar.

Word stops automatically each time it find what it consider an error and then the Spelling and Grammar dialog box opens showing the error highlighted in red.

Figure 8.12: Correcting Spelling Errors

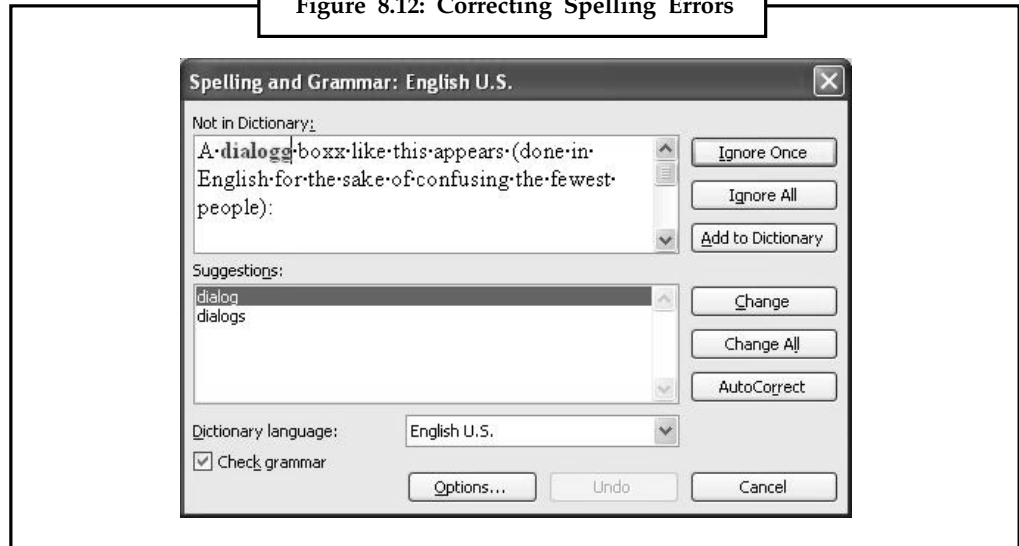

Did u know?

The Check spelling as you type and Check grammar as you type settings will affect any open documents in Word. If other people use the documents, you may want to notify the people that you made this change.



Caution

The correcting spelling option are only suggest the some default spellings

8.6.1 Spelling Error Options

Notes

Not in Dictionary	The text is not a misspelled word but is being flagged because it is not in the dictionary.
Suggestions	Displays a list of suggested corrections and puts the most likely one at the top.
Ignore	To keep the word as it is. However, the checker will query the word if it reappears.
Ignore All	If you want the checker to accept the word for the entire document, click this option.
Add	Adds the selected word to the active dictionary.
Change/Delete	Accept the suggestion in the Suggestion box. If the error is a repeated word, this button changes to Delete which moves the repeated word.
Change All/Delete	Changes all instances of the selection in the current document. If the error is a repeated word, this button changes to Delete All.
AutoCorrect	Adds the error and its correction to the AutoCorrect list
Options	Opens Options dialog box.
Undo	Undoes the last correction made during the current spell check session.
Cancel/Close	Closes the dialog box. The Cancel button becomes the Close button after at least one change takes place.

8.7 Quick Spelling Checking

The Spelling and Grammar button on the Standard toolbar is a quick way to check the spelling of a single word, a paragraph or any other selection of text.

Another way to check spelling quickly is by pressing F7.

Word can automatically check spelling as the user types the text in. To correct the error immediately, right-click the offending word to open a context-sensitive shortcut menu. The status bar also displays three icons indicating the current spelling grammar status of document.

Notes

Figure 8.13: Quick Spelling Checking

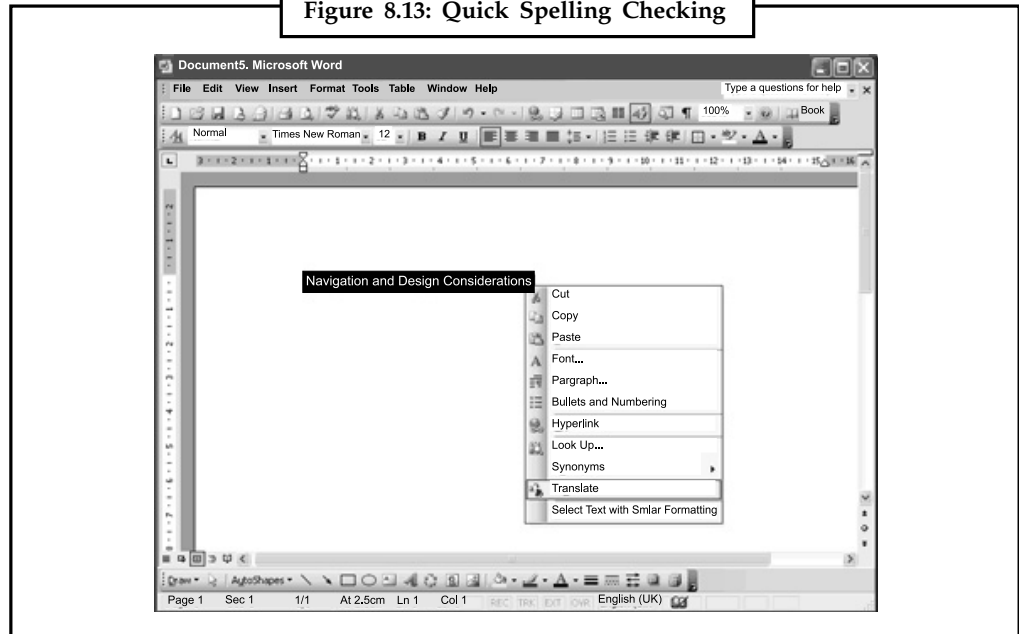

8.8 Using Automatic Spell-Check

Word automatically underlines misspelled words with a red *wavy* line. Spell-checking and underlining occurs as the user types. The steps to run an automatic spell-check are:

- Select Tools >> Options menu the Options dialog box is displayed.
- Select the Spelling & Grammar tab.
- Select the automatic spell-checking check box.

Figure 8.14: Automatic Spell-Check

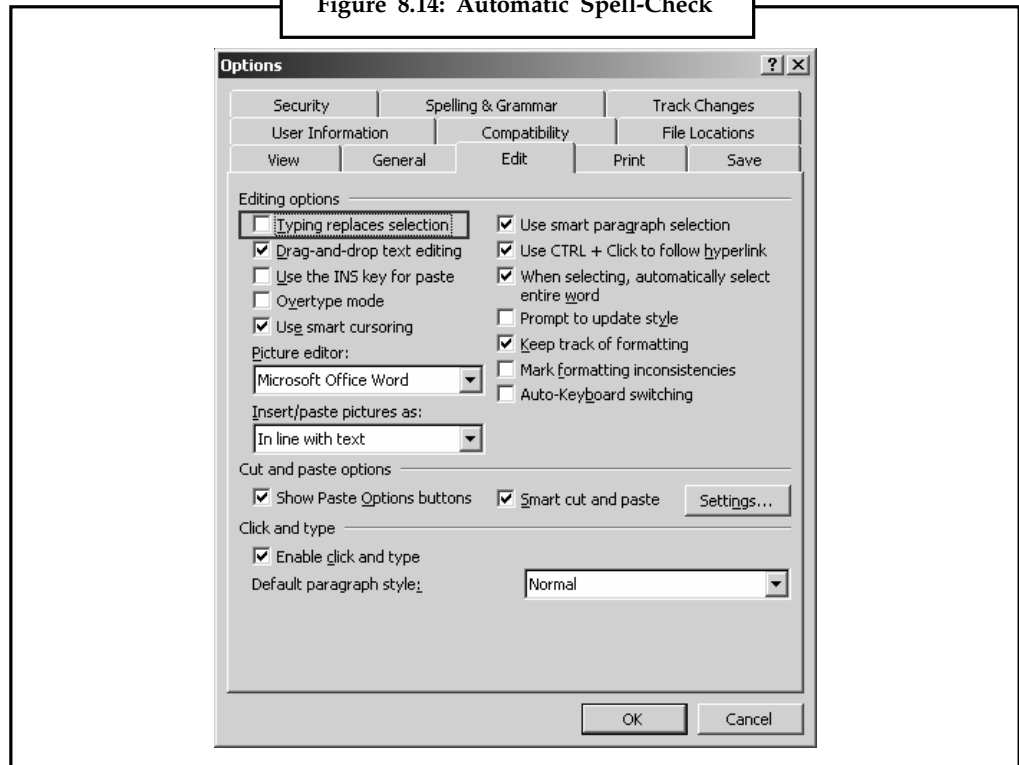

8.9 Using the Grammar Command

Notes

Word's grammar-checker uses rules to identify problems in the user's writing such as passive verbs, pronoun errors, possessive noun errors, homonym problems (like "there" and "their"), and even political incorrectness. To deactivate spell-checker while checking grammar, choose Tools >> Options, click the Grammar tab, and uncheck the Check Spelling option and other rules. To run the grammar-checker from menu:

- Select the sentence to be checked. For entire document, do not select anything
- Choose tools >> Spelling and Grammar, to begin the grammar check
- The Spelling and Grammar dialog box appear each time, when possible error is caught.

Figure 8.15: Grammar Command

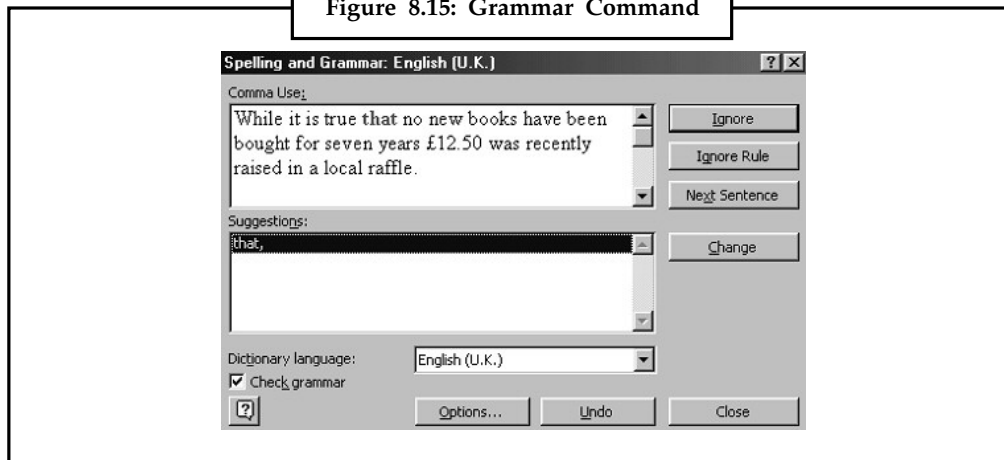

8.9.1 Document Statistics and Readability Estimates

When the grammar check is finish, Readability Statistics dialog box is displayed (Unless show readability statistics check box of Grammar Option button is opted).

Figure 8.16: Document Statistics and Readability Estimates

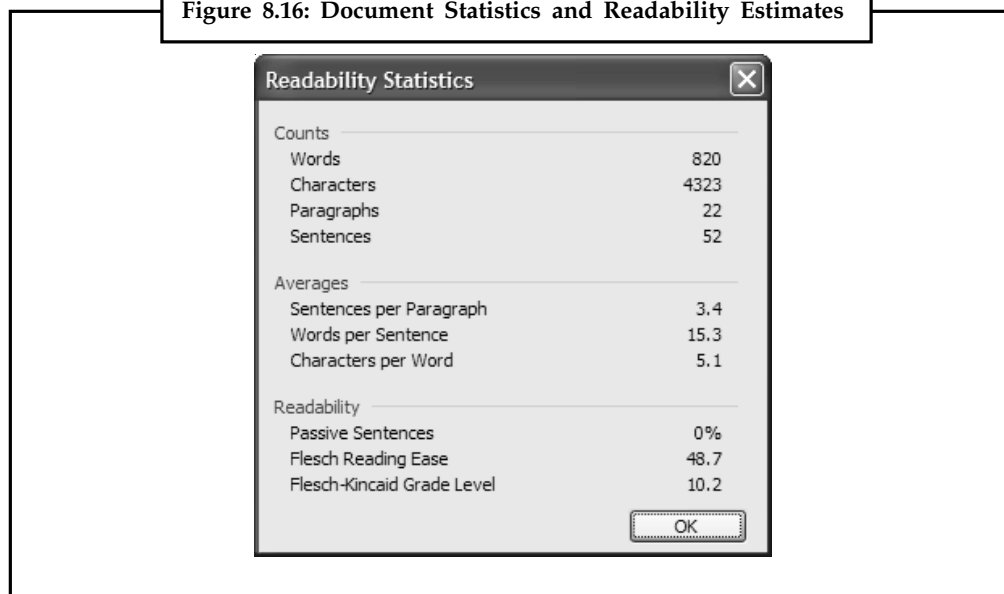

Notes

Document statistic in this dialog box include the number of characters, words, sentences, and paragraphs in the document. They also show the average number sentences per paragraph; words per sentence, and characters per word. The readability level of a document is often measured in term, of a grade level.

8.10 Using the Synonyms Thesaurus

A Thesaurus is a tool used to find a synonym (a word that means essentially the same as the word it replaces). Word's Thesaurus also displays antonyms for some words. An antonym is a word that means the opposite of the selected word. To use the Thesaurus to find synonyms:

- Select the word whose synonym has to be found.
- Choose Tools >> Language >> Thesaurus. This displays the Thesaurus dialog box.

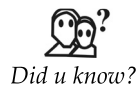

You can also press Shift and the F7 key simultaneously to activate the thesaurus. The thesaurus window pops up.

- Select the required options.

Figure 8.17: Using the Thesaurus

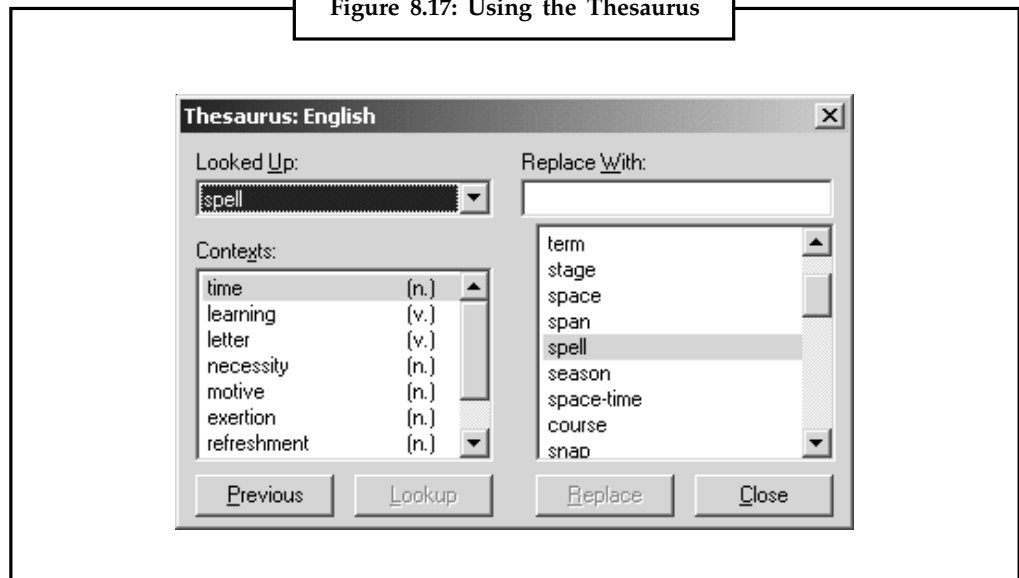

8.11 Using AutoCorrect and AutoText

Both the AutoCorrect and AutoText commands quickly insert frequently used boilerplate text and graphics.

With AutoCorrect, Word inserts previously created entries (by user) automatically as the user types. Because AutoCorrect inserts text automatically as you type, you can use it to automatically correct your most common typing and spelling errors.

AutoText entries are inserted after the user chooses the AutoText command or types the entry name and urea a shortcut key.

8.11.1 Creating AutoCorrect Entries

Notes

Word comes with a set of predefined AutoCorrect entries, for example, to correct two initial capitals and to capitalize first letter of each sentence. There are two ways to create an AutoCorrect entry:

- Add entries to AutoCorrect during a spell-check.
- Add entries to AutoCorrect directly.

Figure 8.18: Creating AutoCorrect Entries

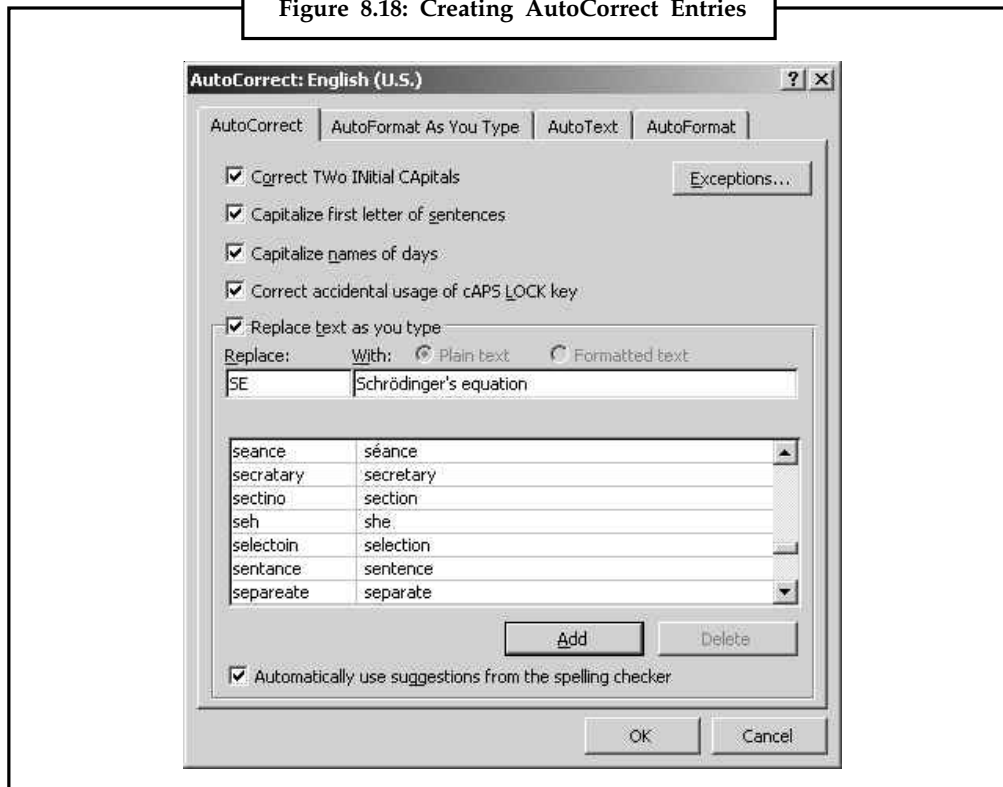

To add entries to AutoCorrect directly:

- Choose Tools >> AutoCorrect. This displays the AutoCorrect dialog box.
- In the Replace text box, type the desired word that is often misspelt and need to be corrected automatically.
- In the With text box, type the correct spelling of that word.
- Click on the Add button.
- Click the Exceptions button to enter exceptions to First Letter tab or the INitial CAPs tab (optional step).
- Click OK twice to return to the document.

Notes

Figure 8.19: Auto Correct Exception

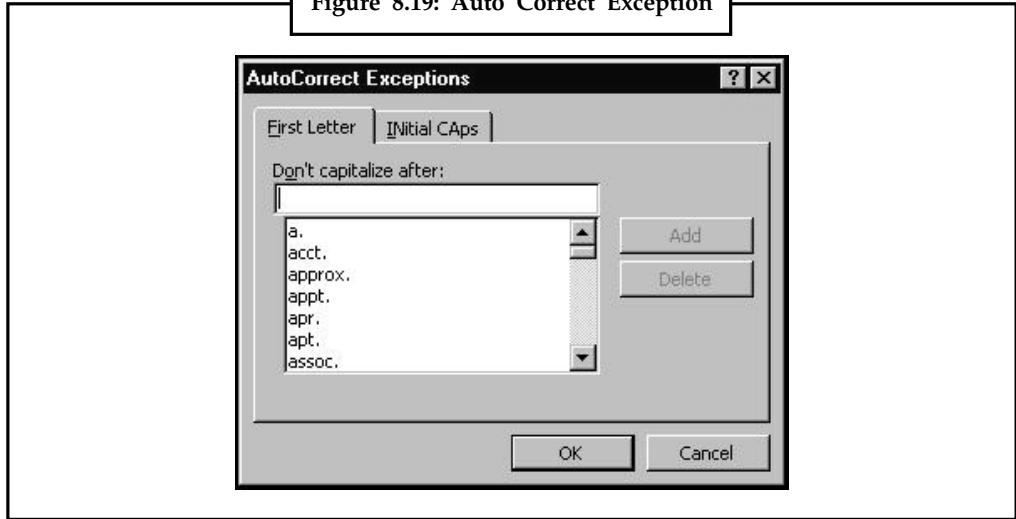

Did u know?

Word is already set up to automatically correct some words. For example if you type "hte" it will be corrected to "the" when you press the spacebar. Word can learn your common mis-spellings and it is relatively easy to add new words.

8.11.2 Creating AutoText Entries

To create an AutoText entry:

- Select the text to store as an AutoText entry.
- Use the AutoText toolbar, or select Insert >> AutoText from the menu.

Figure 8.20: Auto Correct

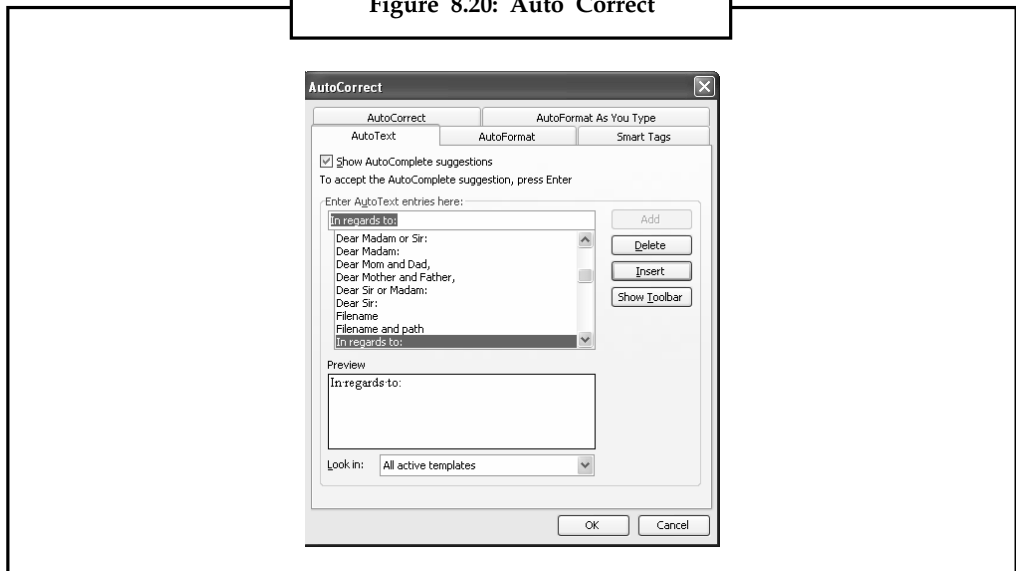

- Accept the default name, or type a new abbreviated name in the “Enter AutoText entries here” box. An AutoText name can have up to 32 characters, including spaces.
- Click on the Add button.

Notes



The **Plain Text** and **Formatted Text** options are only available if you selected the text from your document, rather than typing it into the “With” box. Also, if you selected text to add to AutoCorrect, and it comes up with the Formatted Text already marked, then you should leave it as Formatted Text. If you change it to Plain Text, it may not work properly.

8.11.3 Inserting AutoText Entries

There are three ways to insert an AutoText entry.

- Using Keyboard Shortcut
 - ❖ Position the insertion point where the AutoText entry will be inserted.
 - ❖ Type the name of the entry or just enough letters to uniquely identify the name of an AutoText entry.
 - ❖ Press F3 function key.
- Using the AutoText toolbar
 - ❖ Position the insertion point where the AutoText entry will be inserted.
 - ❖ Click the scroll down menu in the middle of the AutoText toolbar.
 - ❖ Select the desired entry to insert, and press Enter.
- Using the AutoText- dialog box
 - ❖ Position the insertion point where the AutoText entry will be inserted.
 - ❖ Choose Insert >> AutoText or click the “AutoText” menu on the AutoText toolbar.
 - ❖ In the Enter AutoText entries here box, type or select an AutoText name.



Auto Text entries are divided into categories such as **Closing** or **Salutation**. Check the **Normal** category for entries you’ve created unless you know they are stored under another category.



Don’t create AutoCorrect shortcuts using text that would commonly be used for other things. For example, you wouldn’t want to use “mr” as a shortcut for “medical records” because if you tried to type “Mr. Jones”, you would get “medical records” as soon as you typed the period at the end of “Mr”.

8.11.4 Using the AutoComplete

Word automatically finishes the word “Thursday” if user types thur and presses Enter. Similarly, typing the first couple of letters in your name prompts Word to finish it. This feature extends to months, current date, and your own AutoText entries.

Notes

On the Tools menu, click AutoCorrect and then click the AutoText tab.

Select or clear the Show AutoComplete tip for AutoText and dates check box (refer to previous dialog box).

8.12 Hyphenating Documents

Hyphenating allows more text to be fitted on a page. It tightens justified paragraphs and reduces the ragged appearance of unjustified text. Word offers four methods to hyphenate text:

- Automatically hyphenate
- Manually hyphenate
- Insert optional hyphens
- Insert non-breaking hyphens

The hyphenation options are available through the Language option on the Tools menu.



Case Study

Template for Submitting Community Success Stories

Use the Microsoft Word document Success Story Template. Fill in the template and save the document to your desktop.

Community Success Story Template

- Required Field
- Program Name
- Name of Organization
- City
- Province/Territory
- Population Size Served
- Program Start/End Date
- Contact Name
- Contact Phone/Email

Introduction (Brief- i.e. *location, target groups, need for program, organization(s) involved*)

- General description of the program (i.e. *how the program was initiated, who was involved (leaders/partners), how was it funded, what actually happened*)
- Challenges/Solutions (i.e., *anything to be done differently next time or advice for other communities*)
- End result of the program (i.e., *what was accomplished, what feedback received?*)

Contd...

- Next steps (i.e., are there any future plans for the program?)
- Conclusion (i.e., short summary, closing words of wisdom!)

Questions:

1. What is the use of template in word file?
2. How to insert template in the document file?

8.13 Summary

- MS word tells us about specific functions, which we can use in the word documents.
- Find and Replace option of word is convenient way of searching for particular word in whole document.
- Numbering feature, it acts like the bullets only which used number instead of bullets in the text document.
- Spelling and grammar button is the standard Toolbars to check the spelling and any graphemically errors in the text document.
- Auto correct feature inserts text in the heard document automatically.

8.14 Keywords

AutoComplete: AutoComplete is a feature in Microsoft Word that enables Word to guess what you are typing when you enter commonly used document words. This feature can save time if you know how to use it.

AutoCorrect: **AutoCorrect** is best used for creating shortcuts for words, phrases, and even images. For example, if you often type Microsoft Word, you could create a shortcut such as “msw”. Then any time you typed “msw”, it would expand to Microsoft Word.

AutoText: **AutoText** is best used for longer phrases or paragraphs (for example, “boilerplate” text for disclaimers or a standard closing for a letter). AutoText is also already setup with several standard AutoText entries.

Footer: One or more lines of text that appear at the bottom of every page of a document. Once you specify what text should appear in the footer, the application automatically inserts it.

Header: A header is the text that goes on the top of each page. In MS Word you can set it to automatically print on each page, along with a variety of other information, like the page number.

Hyphenation: Hyphenation is the process of adding hyphens to words at the beginning of lines so the hyphenated part will fit at the end of the previous line. The hyphens are inserted between syllables in a word.

Thesaurus: A thesaurus is a collection of synonyms and antonyms to a word. When you look up a word in a thesaurus, it will provide alternative words that you can also use.

8.15 Self-Assessment Questions

Multiple Choice Questions:

1. Why are headers and footers used in document?
 - (a) To enhance the overall appearance of the document
 - (b) To mark the starting and ending of a page
 - (c) To make large document more readable
 - (d) To allow page headers and footers to appear on document when it is printed.,
2. Which of the following shortcut key is used to check spelling?
 - (a) F1
 - (b) F2
 - (c) F7
 - (d) F9
3. What is the minimum number of rows and columns that a word table can have?
 - (a) Zero
 - (b) 2 rows and 1 column
 - (c) 2 rows and 2 column
 - (d) 1 row and 1 column
4. What is the Thesaurus used for?
 - (a) Spelling options
 - (b) Grammar options
 - (c) Synonyms and Antonyms
 - (d) Opposite Words
5. Which word processing utility could you use to find the synonym of a word?
 - (a) Spell checker
 - (b) Thesaurus
 - (c) Out-liner
 - (d) Grammar checker
6. Which of the following is not the feature of MS-Word?
 - (a) Margins and page length can be adjusted as desired
 - (b) Spelling can be checked and modified through the spell check facility
 - (c) Provides tools such as data consolidation, goal seek, scenario etc.
 - (d) Multiple document/files can be merged
7. If you need to edit header or footer of a document which menu should you access?
 - (a) Insert
 - (b) Edit
 - (c) View
 - (d) Tools
8. Which menu should you access to create new footnotes?
 - (a) Insert
 - (b) Edit
 - (c) View
 - (d) Tools
9. Text in a cell of a table in Word needed to be printed vertical, how can you perform this?
 - (a) Click the free rotate button on drawing toolbar and rotate it to make vertical.
 - (b) Select Flip Vertical from Draw Menu.

- (c) Choose Text Direction from Format Menu
 (d) None of these

Notes

State Whether True or False

1. A Thesaurus looks up for synonyms and antonyms.
2. All the words highlighted during a spell-check are spelled incorrectly and must be changed.
3. Spelling-checker checks only for spelling not usage.
4. AutoText feature is used to convert numeric entries into character entries.
5. Word highlights words that are not in its dictionary when you end the word.
6. AutoComplete features can be used to complete the documents automatically by inserting specified text at specified location in the document.

8.16 Review Questions

1. List some of the word proofing tools.
2. What is the AutoText feature used for?
3. How can you automate the word correction process? How will you create an AutoCorrect entry?
4. What are the various spelling error options available in Word?
5. What is the use of Grammar command?
6. What is Thesaurus?
7. In your document, you have typed the word file as “file” but you want to find and replace all the occurrences of this word to “File”. How would you do this?
8. How will you create an AutoText entry?
9. What do you understand by AutoComplete feature of Word?
10. Briefly explain how would you search a particular character in the document and replace it with another.

Answers for Self-Assessment Questions

Multiple Choice Questions:

- | | | | |
|--------|--------|--------|--------|
| 1. (d) | 2. (c) | 3. (d) | 4. (c) |
| 5. (b) | 6. (c) | 7. (c) | 8. (a) |
| 9. (c) | | | |

True or False:

- | | | | |
|---------|----------|----------|----------|
| 1. True | 2. False | 3. False | 4. False |
| 5. True | 6. True | | |

Notes

8.17 Further Reading



Fundamental Computer Concepts, William S. Davis



<http://books.google.co.in/bkshp?hl=en>

Unit 9: MS Word: Additional Features

CONTENTS

Objectives

Introduction

- 9.1 Handling Graphics
 - 9.1.1 Inserting Pictures in Documents
 - 9.1.2 Inserting Clip Art and Pictures
 - 9.1.3 Insert Picture Objects in Documents
 - 9.1.4 Linking Graphics
 - 9.1.5 Resizing and Cropping Pictures
 - 9.1.6 Drawing in Word
- 9.2 Setting Page Size and Margins
 - 9.2.1 Inserting Section Breaks
 - 9.2.2 Working with Columns
 - 9.2.3 Formatting Pages
 - 9.2.4 Setting Margins
 - 9.2.5 Changing Pagination
 - 9.2.6 Aligning Text Vertically on a Page
 - 9.2.7 Header and Footer Toolbar
- 9.3 Printing Documents
 - 9.3.1 Using Print Preview before Printing
- 9.4 Mail Merge
 - 9.4.1 Merging Letter and Address Files
 - 9.4.2 What is Merging
 - 9.4.3 Writing Form Letters
 - 9.4.4 Functions of the Mail Merge Toolbar Buttons
 - 9.4.5 Creating the Form Letter
 - 9.4.6 Inserting Merge Field
 - 9.4.7 Merging the Main and Data Source Document
 - 9.4.8 Merging Specific Records
 - 9.4.9 Setting the Record Order
 - 9.4.10 Creating Envelopes and Mailing Labels

Notes

- | | |
|-----|---------------------------|
| 9.5 | Summary |
| 9.6 | Keywords |
| 9.7 | Self-Assessment Questions |
| 9.8 | Review Questions |
| 9.9 | Further Readings |

Objectives

After studying this unit, you will be able to:

- Understanding of handling Graphics in MS Word
- Explanation of setting page size and margins
- Understanding of printing document
- Discussion of mail merge
- Working of mail merge

Introduction

Microsoft Word is part of the Microsoft Office. Its main function is for producing documents that can includes text, graphics, table, clip art, etc.

9.1 Handling Graphics

Adding graphics or picture to illustrate your documents makes them more appealing.

Graphics format falls into two camps: bitmap and vector. Bitmap graphics are composed of small dots, called pixels. Each pixel is represented by one or more bits in the computer's memory that define colour and intensity. Vector graphics, in contrast comprise of a set of drawing instructions that describe the dimension and shape of every line, circle, arc, or rectangle.

9.1.1 Inserting Pictures in Documents

In Word, a picture can be inserted in the document in one of three ways:

- Use the Insert >> Picture command and choose either the Clip Art or From File submenu.
- Use the Insert >> Object command to insert a picture that you plan to link to a graphics program.
- Open the program used to create picture, and copy (or cut) a picture to the Windows clipboard. Then use the Edit >> Paste command to paste the picture into your Word document.

9.1.2 Inserting Clip Art and Pictures

Choose Insert >> Picture >> Clip Art, Microsoft Clip Gallery 3"0 dialog box appears with Clip Art tab selected.

- Choose Insert button after selecting the desired picture.
- Microsoft Office and Word comes with a Clip Art library of pictures. Office stores the Clip Art in the folder Microsoft Office\Clipart.

- To insert a picture from a file into document:
 - ❖ Position the insertion point where the picture will be inserted.
 - ❖ Choose Insert >> Picture >> From File. The Insert Picture dialog box appears.
 - ❖ From the file name list, select the picture file that you want to insert.
 - ❖ Choose Insert.

Notes

Figure 9.1: Inserting Clip Art and Pictures

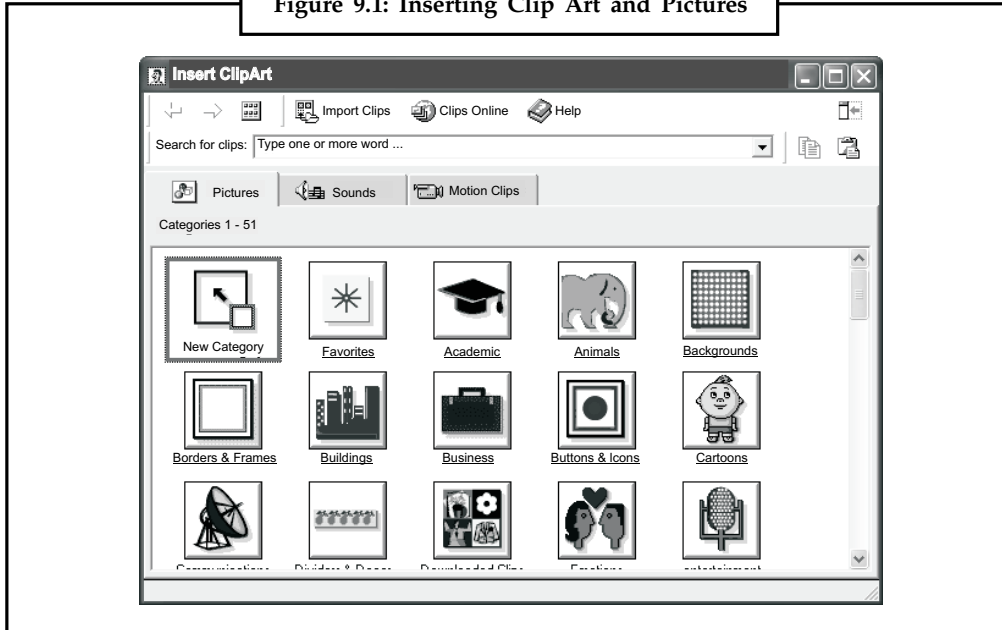

9.1.3 Insert Picture Objects in Documents

A picture object is a picture that can be edited in a Word document. It is not linked to a file outside the document.

Figure 9.2: Inserting Picture Objects in Documents

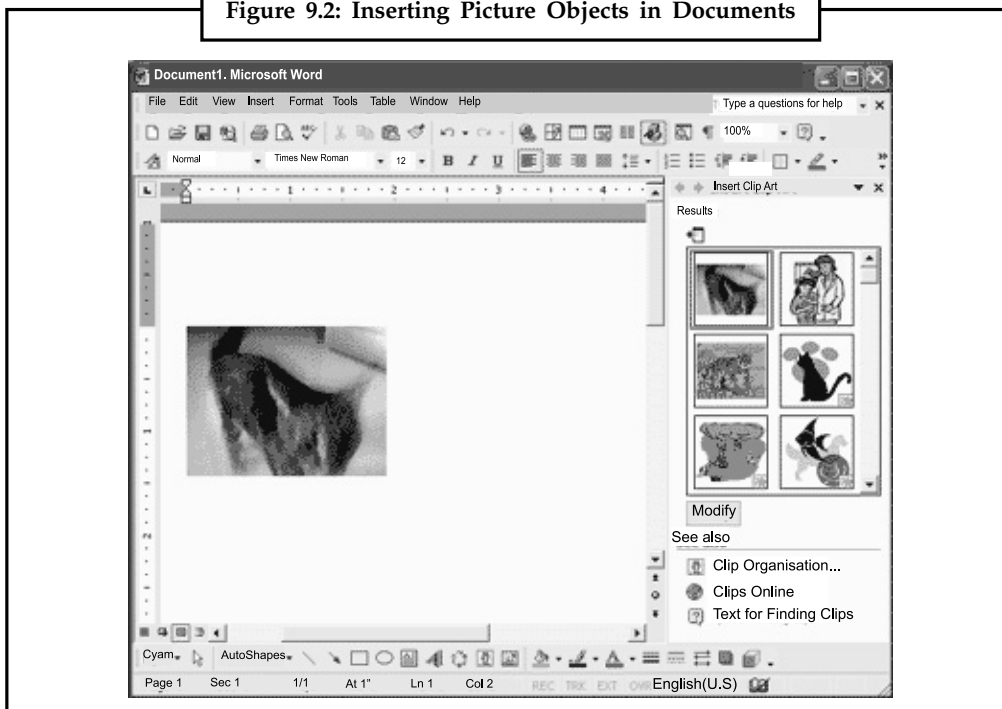

Notes

To insert a picture object into document:

- Position the insertion point where the picture object will be inserted.
- Choose Insert >> Object dialog box appears.
- Do one of the following:
 - ❖ To create a new picture select Create New tab. From The Object type list, select the type of picture object to insert. Choose OK.
 - ❖ Select the Create from File tab, to insert an existing file.
- Return to Word document from graphics program.

9.1.4 Linking Graphics

If you are using a graphic created in another Word-compatible program, you can choose Link to file in the Insert Picture dialog box (Insert >> Picture >> From File) or in the Create from File tab in the Object dialog box (Insert >> Object). To link picture file to a Word document:

- Position the insertion point where the picture will appear.
- Choose Insert >> Picture >> From File and select the picture file to insert.
- Choose the Link to the file option and clear the Save with document option.
- Choose Insert. If you move or edit the original picture file, you can update the link by positioning the insertion point on the picture placeholder and pressing F9.

9.1.5 Resizing and Cropping Pictures

A picture can be scaled or stretched to a smaller or larger size: proportionally or non-proportionally. You can crop parts of a picture that you do not want to display.

To resize and crop a picture using the mouse:

- Select the picture you want to resize or crop. Display the Show Picture toolbar using right click.
- Do one of the following:
 - ❖ To crop the picture, click the Crop button in the Picture toolbar.
 - ❖ To resize the picture, move the mouse pointer over a selection handle. The pointer turns into a two-headed arrow.

To resize and crop a picture using Picture dialog box:

- Choose Format >> Picture or choose the Format Picture button to display the Format Picture dialog box.



Did u know?

If the inline graphics in your document appear “chopped off,” it could be directly related to the formatting within the paragraph containing the graphic.

Figure 9.3: Resizing and Cropping Pictures

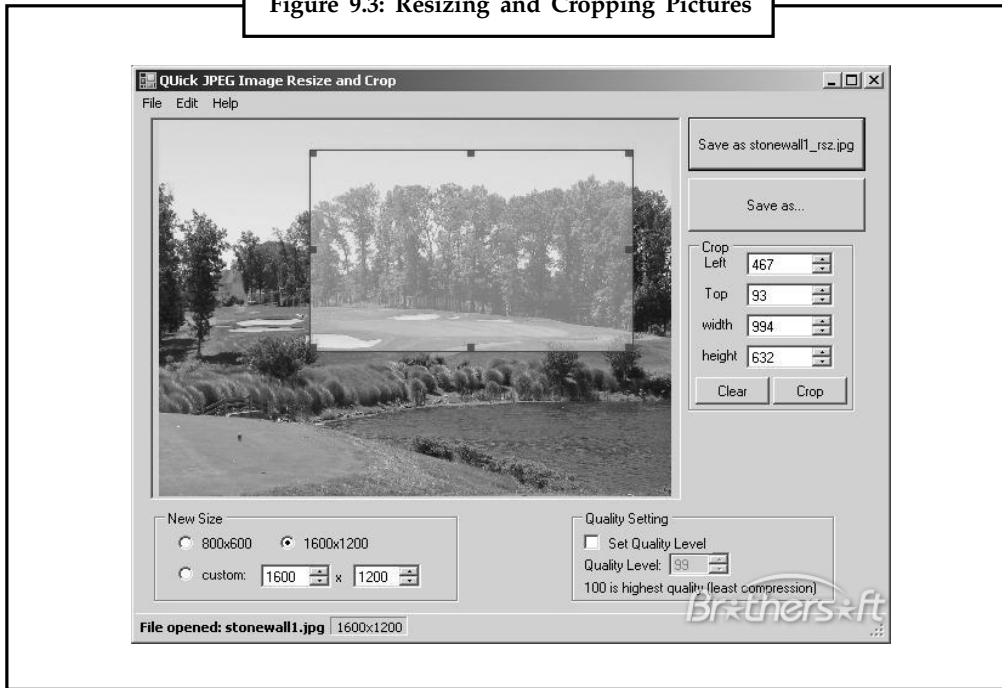

9.1.6 Drawing in Word

Word's drawing features are built directly into Word. Using Word, the user can create vector images, called "objects". A Word drawing can comprise many objects, such as lines and circles. These objects which you draw, appear directly on the page. You then can move them anywhere on the page.

Using the Drawing Toolbar

- In Word, a drawing can be created using the Drawing toolbar.
- Click the Drawing button on the Standard toolbar.
- Figure below shows a floating drawing toolbar.

9.2 Setting Page Size and Margins

Working with sections is essential to create a page with multiple columns. Page formatting includes margins, headers, footers, and page numbers.

Sections

Section breaks divide a document into sections. By default, Normal template creates an entire document as a single section. Sections are used for any of the following type of formatting

- Columns
- Headers and Footers
- Margins
- Page Orientation
- Page Numbering

Notes

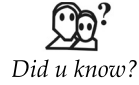

To change the default margins, click **Margins** after you select a new margin, and then click **Custom Margins**. In the **Page Setup** dialog box, click the **Default** button, and then click **Yes**. The new default settings are saved in the template on which the document is based. Each new document based on that template automatically uses the new margin settings.

9.2.1 Inserting Section Breaks

Section breaks are always visible in Normal view. They appear as double-dotted lines containing the words “End of Section”. A section break mark the point in a document where new formatting begins. To insert a section break:

- Position the cursor from where a new section starts.
- Choose Insert >> Break.
- Choose one of the following options in the Section break types.
 - ❖ **Next page** radio button to insert a section break and begin the new section at the top of the next Page.
 - ❖ **Continuous** radio button to insert a section break and begin the new section on the same page, below the previous section.
 - ❖ **Even page** radio button to insert a section break and begin a new section on an even-numbered page.
 - ❖ **Odd page** radio button to insert a section break and begin a new section on an odd-numbered page.

Figure 9.4: Inserting Section Breaks

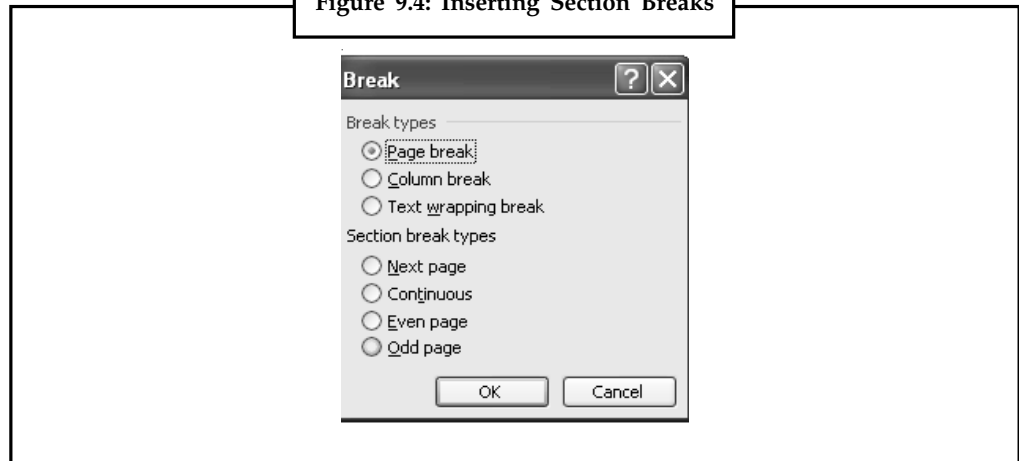

- Choose OK.

To delete a section break, select the section break and press the Del key.



Create a document and use page break.

9.2.2 Working with Columns

Word enables you to create newspaper-style columns to make text more appealing and readable. Two methods of creating columns are:

- Choose the Format >> Columns command.
- Choose the Columns button on the Standard toolbar.

The first method opens a dialog box from which the desired formatting can be selected.

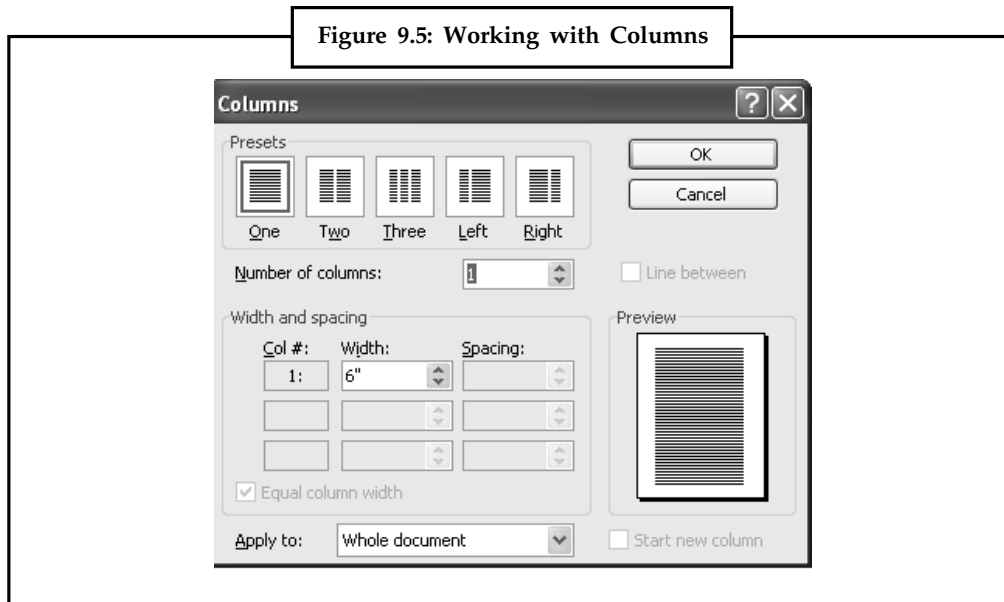

The second method can be used to select the number of evenly sized and spaced columns (upto six). Both methods automatically switch to Print Layout view.

9.2.3 Formatting Pages

Formatting pages means changing the margins, paper size, orientation or headers and footers. Word enables you to apply page setup formatting options to a selection, a section, multiple sections, or the entire document.

9.2.4 Setting Margins

Margins are the borders on all four sides of a page within which the text of the document is confined. Word sets default margins with a 1 inch top and bottom margins and 1.25 inch left and right margins.

Setting margins by using the Page Setup dialog box:

- Position the cursor in the section for which you want to set the margins, or select the text or sections you want formatted.
- Choose File >> Page Setup. The Page Setup dialog box appears.



Notes

You can also use the **Horizontal alignment** option buttons to position your graphic quickly, or you can drag the graphic to where you want it.

Notes

Figure 9.6: Setting Margins

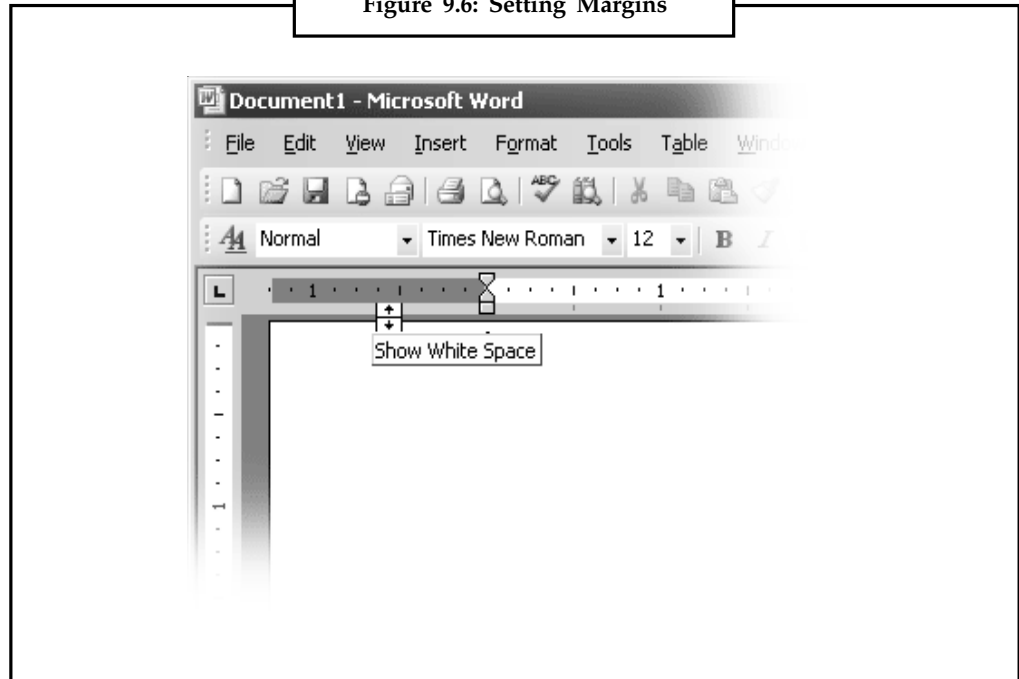

- Select the Margins tab.
- Choose the Top, Bottom, Left, or Right margin settings.
- Choose OK after you are satisfied with the new margins.

A convenient way to set margins for your document or for a section is to use the ruler and mouse. You must display the document in Print Layout or Print Preview view to change the margins on all four sides of your document. To change margins with a ruler:

- Position the cursor in the section where you want to set the margins.
- Choose View >> Page layout. If your ruler does not appear, choose View >> Ruler to display it.
- Position the pointer over the margin boundary that you want to change.
- Drag the margin boundary towards the edge of the page to make the margin smaller or towards the centre of the page to make the margin wider. A dotted line appears showing you where the new margin will be. Holding down the Alt key as you drag variables you to see margin measurements in the ruler.

If you change your mind about changing a margin, press Esc before you release the mouse button or click the Undo button (or choose Edit >> Undo) after you release the mouse button.



Did u know?

To change the default margins, click **Margins** after you select a new margin, and then click **Custom Margins**. In the **Page Setup** dialog box, click the **Default** button, and then click **Yes**. The new default settings are saved in the template on which the document is based. Each new document based on that template automatically uses the new margin settings.

Changing Paper Size and Orientation

Notes

Changing the paper size enables you to create documents other than the standard 8.5 x 11 inches. Word provides several predefined standard paper sizes such as legal, executive, and envelope. It also gives you the option of defining your own customized paper size. To set paper size and orientation:

- Position the cursor in the section for which the paper size and orientation has to be set, or select the text or sections.

Figure 9.7: Changing Paper Size and Orientation

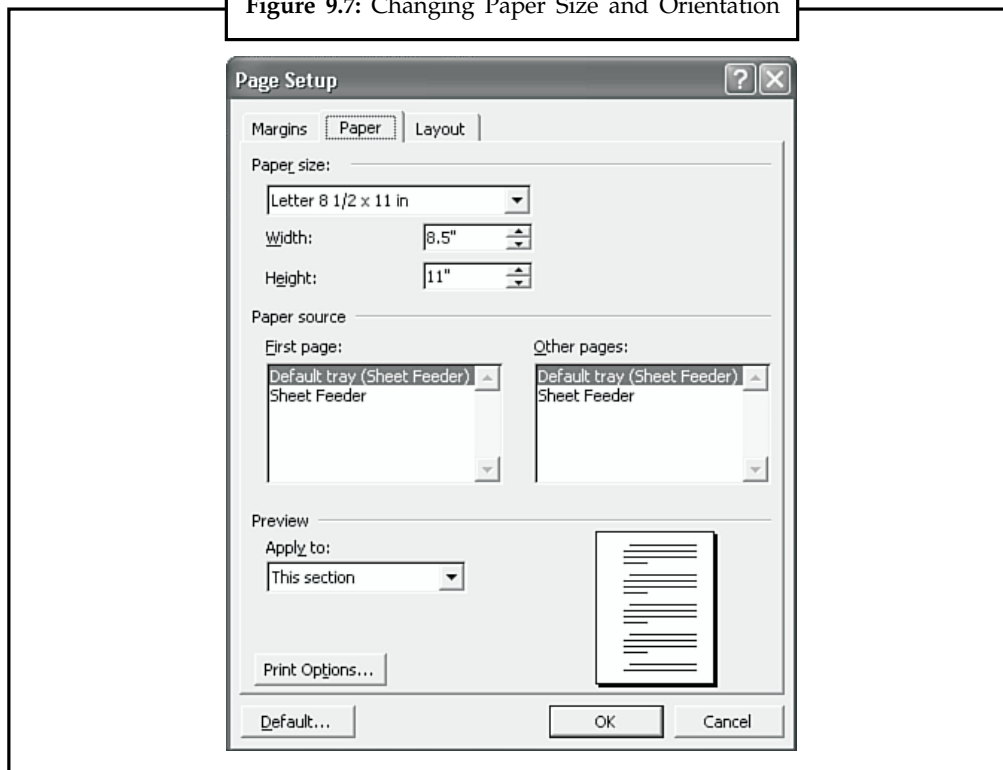

- Choose File >> Page Setup.
- Select the Paper Size tab.
- Do either of these:
 - ❖ Choose a predefined paper size from the Paper size list, or type the width and height of customized paper size.
 - ❖ Choose Landscape (horizontal, sideways page) or Portrait (default vertical, upright page) from Orientation group.
- Choose OK.

9.2.5 Changing Pagination

Word starts a new page automatically when the current page is full. These page breaks are called "soft breaks".

Notes

If you want to force a page to break at a particular place in your document, insert “hard page break”. Word always starts text following a hard page break at the top of the next page. To insert a hard page break:

- Position the cursor at the beginning of the text from where the new page is to start.
- Do either of the following:
 - ❖ Choose Insert >> Break, choose Page break option and choose OK (refer to Break dialog box).
 - ❖ Press Ctrl + Enter.

9.2.6 Aligning Text Vertically on a Page

Word provides three options for vertical alignment of text on a page: Top, Center and Justified. These options determine how Word aligns a partial page of text between the top and bottom margins. To vertically align text on the page:

- Position the cursor inside the section containing the text for alignment.
- Choose File >> Page Setup.
- Select the Layout tab.
- Choose one of the options in the Vertical alignment list.
- Choose OK.

Figure 9.8: Aligning Text Vertically on a Page

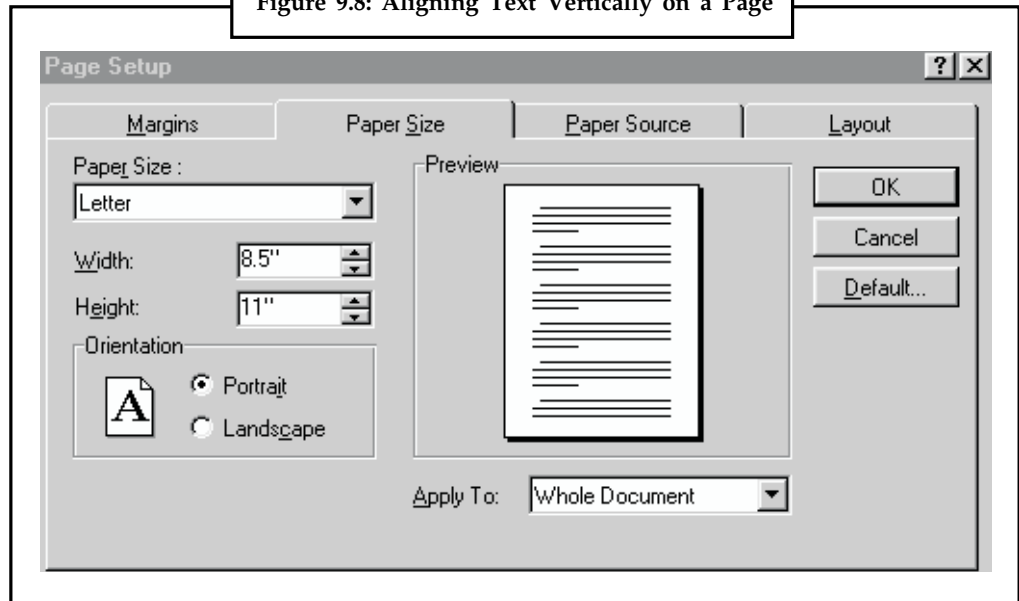

Creating Headers and Footers

Headers and footers are word processing holding areas for repetitive information that must appear either in the top margin (header) or in the bottom margin (footer) of every page of the document. You can create different headers and footers for different sections of document. They can also be different for odd and even pages (refer Page Setup dialog box). Table below explains the function of the buttons on the Header and Footer toolbar.

9.2.7 Header and Footer Toolbar

Notes

Button Name	Description
Insert AutoText	Displays drop-down list of AutoText entries.
Insert Page Number	Inserts a page number field.
Insert Number of Pages	Inserts total number of pages in document.
Format Page Number	Open Page Number Format dialog box.
Insert Date	Inserts a date field. Uses whichever date format you last chose in using the Insert >> Date and Time command.
Insert Time	Inserts a time field.
Page Setup	Opens Page Setup dialog box.
Show/Hide Document Text	Toggles between displaying dimmed body text and graphics in the background or showing no text in background.
Same as Previous	Links or unlinks a header from preceding section.
Switch Between Header and Footer	Toggles between displaying header and Footer footer.
Show Previous	Shows header or footer for preceding section.
Show Next	Shows header or footer for next section.
Close	Closes the Header and Footer toolbar.

To add header or footer to the entire document:

- Choose View >> Header and Footer. \Word displays the Header and Footer toolbar. (See Figure 9.9).

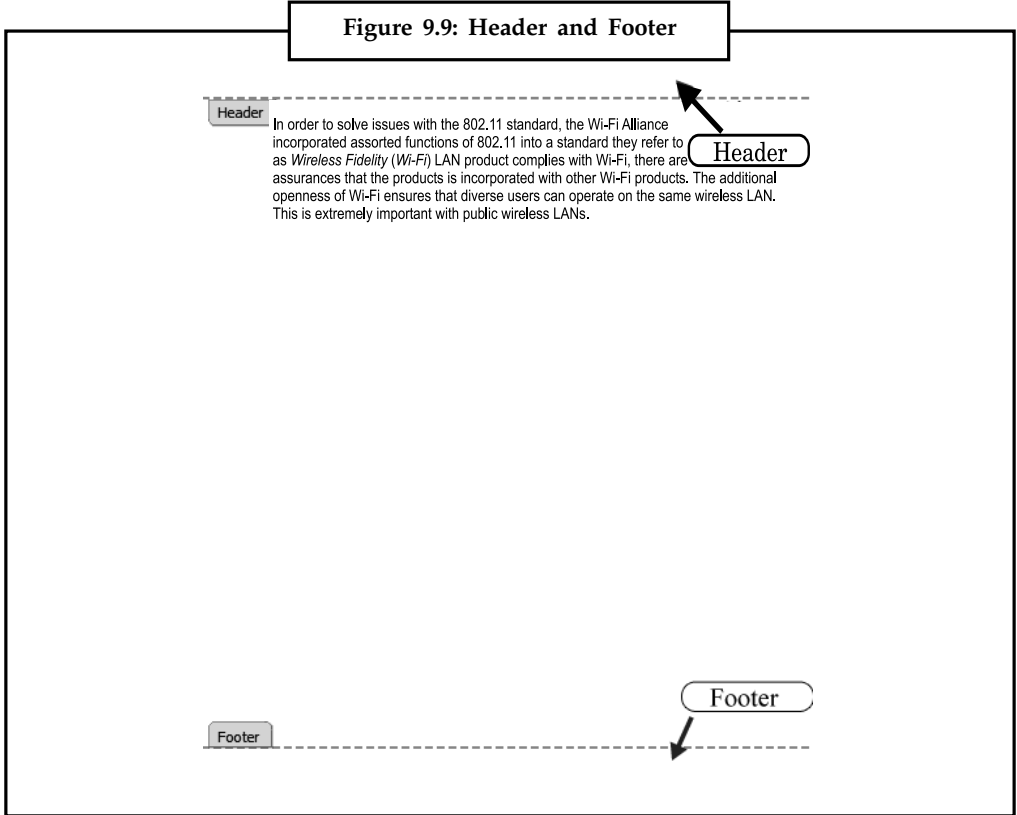

Notes

- To switch between header and footer click the Switch Between Header and Footer button.
- Type the text for header or footer within the dashed line that surrounds the header or footer area.
- Use the Header and Footer toolbar buttons to insert the fields in the header or footer.
- Choose Close or double-click the document to close Header and Footer toolbar and return to document.



- You can use most of the commands in the Insert, Format, Tools, and Tables menus to the format headers, and footers.
- To edit a header and footer, use the same command you used to create it, or in the Print Layout view, double-click the header or footer.

9.3 Printing Documents

Click the Print button in the Standard toolbar, the document goes directly to the printer. To specify what exactly has to be printed use the File << Print command to display Print dialog box.

Figure 9.10: Printing of Document in Microsoft Word

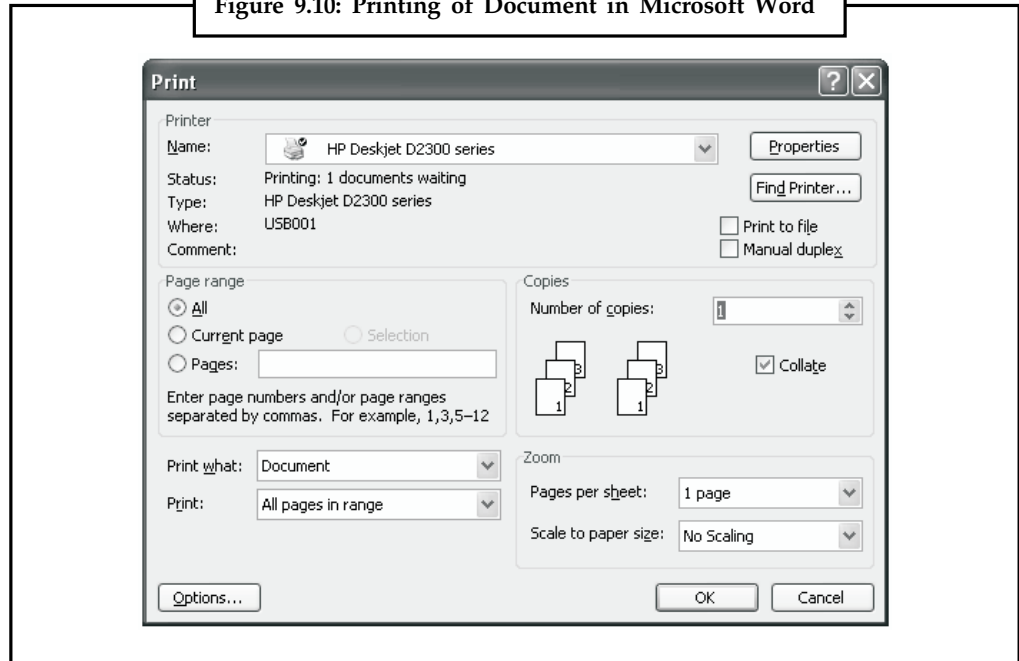

9.3.1 Using Print Preview before Printing

Print Preview command is used to view document in a variety of ways. To preview a document in Print Preview:

- Choose File >> Print Preview or click the Print Preview button on the Standard toolbar.
- To close Print Preview, choose the Close button.

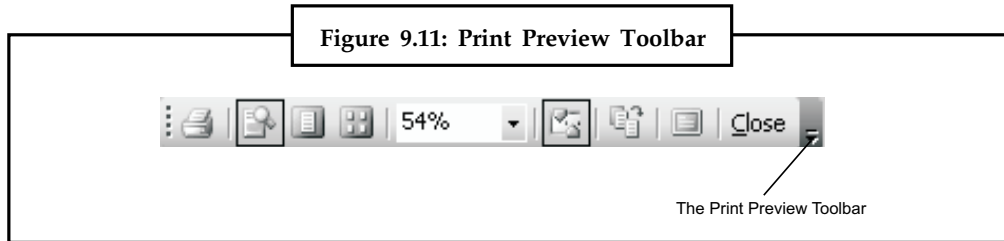

<i>Button Name</i>	<i>Action</i>
Print	Prints the document by using default print options.
Magnifier	Enlarges or reduces the document view.
One Page	Displays the document in single-page view.
Multiple Page	Views one or more pages of a document.
Zoom Control	Select different magnifications, from 10 to 500 percent and other options.
View Ruler	Displays or hides the horizontal and vertical rulers.
Shrink to Fit	Shrinks document to fit on one page or less if the last page of document contains only a few lines of text.
Full Screen	Removes title bar and toolbars to show a full screen display of the document in Print Preview.
Close Preview	Closes Print Preview and returns to your document.
Context Sensitive	Provides Context-Sensitive Help for Print Preview Help options.



Did u know?

Most printers require a minimum width for margin settings, because they can't print all the way to the edge of the page. If you try to set margins that are too narrow, Microsoft Word displays the message **One or more margins are set outside the printable area of the page.**



Task

Insert a picture from clipart and use sort key of print and print the picture.

9.4 Mail Merge

Word's mail merge feature helps in quickly creating documents by combining information from two different files. In mail-merge, you write a letter in one document, enter all your recipients names and addresses in another, and then merge the two to produce as many

Notes

copies as needed. Mail merge enables you to personalize form letters for mass mailing, product announcements, customer letters, reports, and invitations. With mail-merge, it is also possible to combine a list of names and addresses to create invoices and mailing labels. So, instead of typing many individual letters and changing the variable information in each letter, you can tell Word to merge the letter and the variable information, which saves you effort required to type and time. So, if you have a dozen identical letters to write, then you can use mail-merge feature of Word to get the desired results in no time. In this section, you will learn how to use the mail-merge feature to create form letters, envelopes, and mailing labels.

9.4.1 Merging Letter and Address Files

Mail Merge helps in generating multiple copies of a base document (the content of a letter) incorporating some variable information (the name and address of a person) such that each copy appears to the recipient as an original document. Mail Merge saves the user from the effort of typing in each copy separately. The process is called “merging”, and does the following operations:

- Print personalized letters addressed to any number of recipients.
- Print envelopes for the letters.
- Print mailing labels.
- Print lists and catalogs.

The Mail Merge process involves:

- Creating a main document that contains text with some place markers embedded within the text.
- Creating a data source document that lists sets of text that will replace the place markers in the main document.
- Finally, when Word merges the two files, the result is a set of documents, one document for each set of text in the data source document.

The best known use for merging is creating form letters. A typical main document for a form letter consists of the text of the letter with markers indicating positions for an addressee’s name/ street, address, city, state, and pin code. The data source document contains a list of the actual addressee’s names and addresses. Word merges the two documents together to print personalized letters.

9.4.2 What is Merging

The two main documents used by Word in the mail merge process are:

- a main document
- a data source document.

The Main Document

The main document for a form letter contains the text and perhaps graphics, that should be in every letter. The words enclosed in chevrons (<< and >>) in the main document are the field codes that identify data to be inserted from the data source document. Other text in the main document (text not enclosed in chevrons) will appear in every letter.

The Data Source Document

Notes

Data sources are organized collections of information—databases—that you can create easily in Word table. Word can also use data from other applications, such as Microsoft Excel or Microsoft Access. All data sources, no matter where they come from, contain records and fields. Data contains the information that replaces field codes in the main document.

Putting the Two Together

After creating a main document and a data source document, the only thing left is to tell Word to merge them. The result is a set of customized letters.

9.4.3 Writing Form Letters

Word guides you smoothly through the process of creating a form letter. You simply follow the instructions in a sequence of dialog boxes.

Building a New Merge Structure

To begin creating a set of form letters proceed in the following manner.

- Open an empty document, choose Tools >> Mail Merge to open the Mail Merge Helper dialog box.

Figure 9.12: Building a New Merge Structure

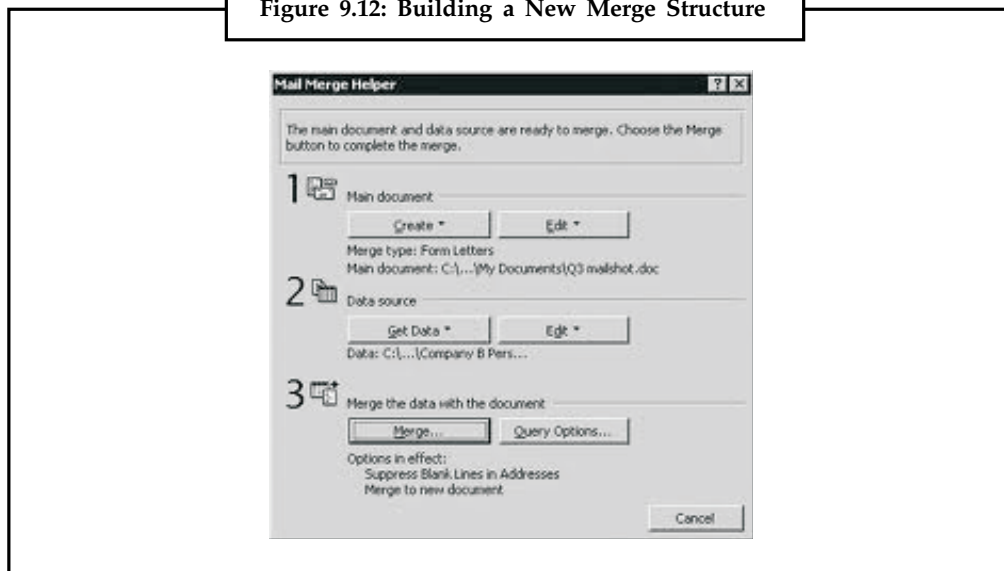

- Choose the Create button to open a list of the types of documents you can create.
- Choose Form Letters open a dialog box in which you choose the Active Window or New Main Document.
- Choose New Main Document option if you started the Mail Merge command before creating the form letter. Choose the Active Window, if you started the Mail Merge command after creating the form letter.

Creating the Data Source Document

Next, you need to create or specify the data source and arrange the fields that you want to be available to your main document for the merge. To define the source data:

Notes

- Choose the Get Data button from the Mail Merge Helper dialog box, to display the list box given below.
- If you already have a data source that you want to use, select Open Data Source. If you want to create the data source, select Create Data Source to display the Create Data Source dialog box.

It offers a list of commonly used field names. Select the predefined field names, change or delete some of the field names, or add other field names.

- Choose OK button of Create Data Source dialog box, a Save As dialog box appears. Word saves the empty data source document and displays the dialog box shown below.
- Choose Edit Data Source to display the Data Form dialog box.
- In Data Form box, enter the details of records in the text boxes provided in front of the field names.
- Press Tab or Return key to move to the next field.
- To add a new record, select the Add New button.
- To delete a record, display the record then choose the Delete button.
- The Restore button brings the entries to their previous state.
- To search for any word or part of a word in any field, select the Find button. Type the text you want to search in the Find what text box, also specify in which field this text will be found. Then click the Find First button.
- Click OK to close Data Source and save the changes (to save data just entered).

Mail Merger Helper dialog box reappears where you can work on the form letter's main document. Click on Edit button under Main document heading.

- A Mail Merge toolbar appears at the top of the screen (Main document).

9.4.4 Functions of the Mail Merge Toolbar Buttons

<i>Name</i>	<i>Function</i>
Insert Merge Field	Inserts a merge field into the main document.
Insert Word Field	Inserts a Word field into the main document.
View Merged Data	Toggles between viewing merge fields and merged data.
First Record	To go to the first record in a data source document.
Previous Record	To go to the previous record in the data source document.
Go to Record	To go to specific record in the data source document.
Next Record	To go to the next record in a data source document.
Last Record	To go to the last record in a data source document.
Mail Merge Helper	Displays the Mail Merge Helper dialog box.
Check For Errors	Check for errors in the merged document.
Merge To New	Displays merged document on-screen.

Merge To Printer	Print merged documents.	Notes
Mail Merge	Displays Merge dialog box.	
Find Record	Finds a record in the data source document.	
Edit Data Source	Edits the data source document.	

9.4.5 Creating the Form Letter

In the empty main document, place two types of data: text that appears in every letter and field codes to mark the positions where text from the data source document will be inserted.

9.4.6 Inserting Merge Field

- Place the insertion point where you want to insert field name. Choose the Insert Merge Field button of the Mail Merge toolbar to display a list of fields in the data source document.
- Select the desired field name to insert into the document.
- The field name is enclosed in chevrons automatically.
- Click the Insert Merge Field button again to insert each field in the document.
- Type the body of the letter, that is, the text that is common.
- After completing the main document, save it.

9.4.7 Mail Merge Error Checking

Error checking is an important step before you start printing. To check main and data source documents for error:

- Choose Merge in the Mail Merge Helper dialog box to display the Merge dialog box or click Mail Merge tool from the Mail Merge toolbar.
- Choose Check Errors button to display the Checking and Reporting Errors dialog box.
- Choose the second option (the default option), or one of the other options you prefer and then choose OK. If \ford detects no errors, the Merge dialog box reappears, otherwise it displays a message box to tell the user the nature of that error.
- Choose the New document from the Merge To list box and then click Merge button of the Merge dialog box to create a new document that contains all your merged documents as a single document as shown in the figure below.



Notes

In this step, you can choose Merge To New Document button of the Mail Merge toolbar for the same.

9.4.8 Merging Specific Records

A query enables the user to specify conditions under which a record in the data source document is included when merged. A query can be quite simple, such as asking for records for people in one state, or more complex, such as asking for all the records that have surname “Singh” living in “Lucknow” city. To prepare:

- Open the main document — Form Letter.

Notes

- Query options dialog box can be activated using one of the following:
 - ❖ Choose Tools >> Mail Merge, and from the Mail Merge Helper dialog box, choose Query Options button.
 - ❖ Click Mail Merge Helper button on the Mail Merge toolbar and choose Query Options button.
 - ❖ Choose the Merge button of the Mail Merge toolbar to display the Merge dialog box, choose Query Options button.

Figure 9.13: Merging Specific Records

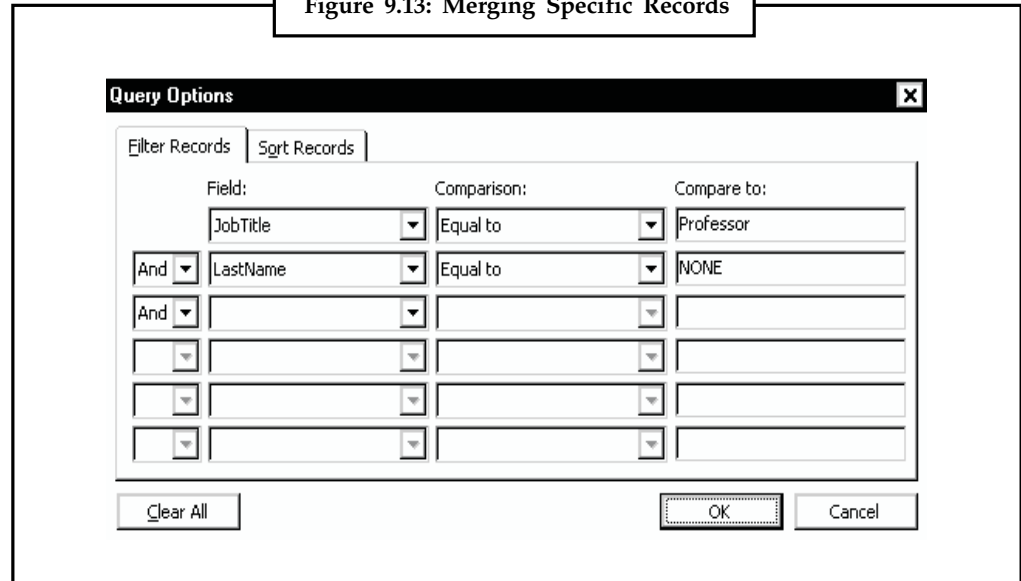

- Select the Filter Records tab.
- In the Field column choose the field you want to use as a filter, for example, City.
- In the Comparison drop-down list, choose the appropriate comparison operator (Equals to, less than).
- In the Compare to box, type the required filtering criteria, for example, Lucknow. Word automatically prepares for an additional query condition by adding And/Or to the second line for more complex queries.
- Choose OK to return to the Mail Merge Helper or Merge dialog box.
- Choose Merge (if using Mail Merge Helper dialog box).
- In the Merge dialog box, select New Document or Merge to Print in the Merge to list box and the All button in the Records to be merged section, and choose Merge.

9.4.9 Setting the Record Order

By default, Word prints merge documents in the same order as records occur in the data source document. By using the Sort option, you can change this order. To sort records:

- Display the Query Options dialog box (described above). Then display the Sort Records tab.

Figure 9.14: Setting the Record Order

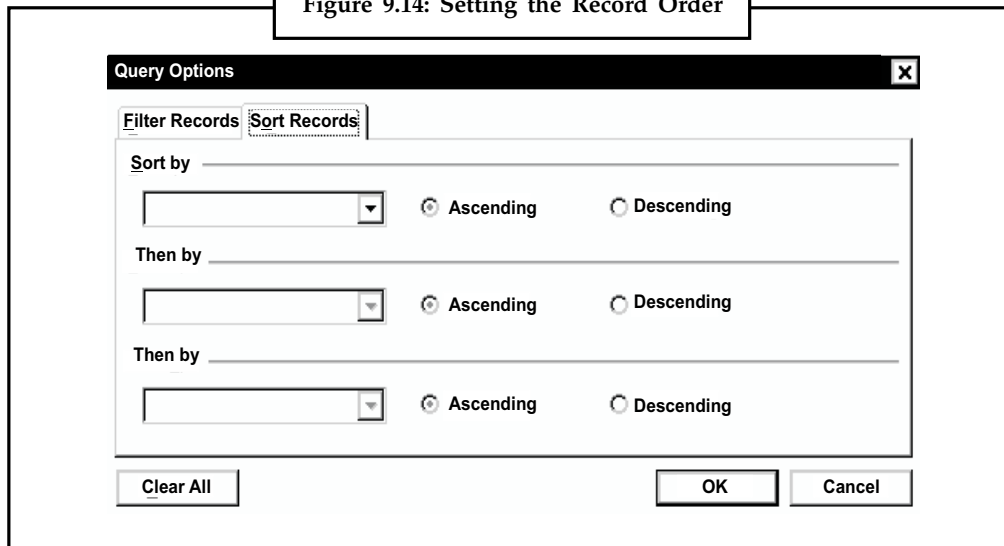

- In the Sort By list box, select the field by which records will be sorted.
- Choose the Ascending or Descending option according to the preference.
- Choose OK to return to the Merge dialog box.

9.4.10 Creating Envelopes and Mailing Labels

You can also use Word's Mail Merge Helper to merge labels of various kinds and envelopes. The procedures to merge labels and envelopes are similar to that of for letters, we will discuss them only briefly here.

Using Mail Merge to Print Envelope

The steps you follow to print envelopes, using an already—existing data source document, are similar to those you use to create form letters except that the envelope is the main document.

Getting Ready to Print Envelope

Preparing to print envelopes is a matter of identifying the data source document, or creating one if it does not already exist, and selecting the envelope size and layout. To identify the data source document:

- Choose Tools >> Mail Merge.
- Choose Create >> Envelopes, and choose New Main Document.
- In the Mail Merge Helper dialog box, choose Get Data.
- To use the existing data source document, select Open Data Source. If you do not have one, choose Create Data Source.

Now to select an envelope size and layout:

- Choose Set Up Main Document to display the Envelope Options tab of the Envelope Options dialog box.

Notes

Figure 9.15: Getting Ready to Print Envelope

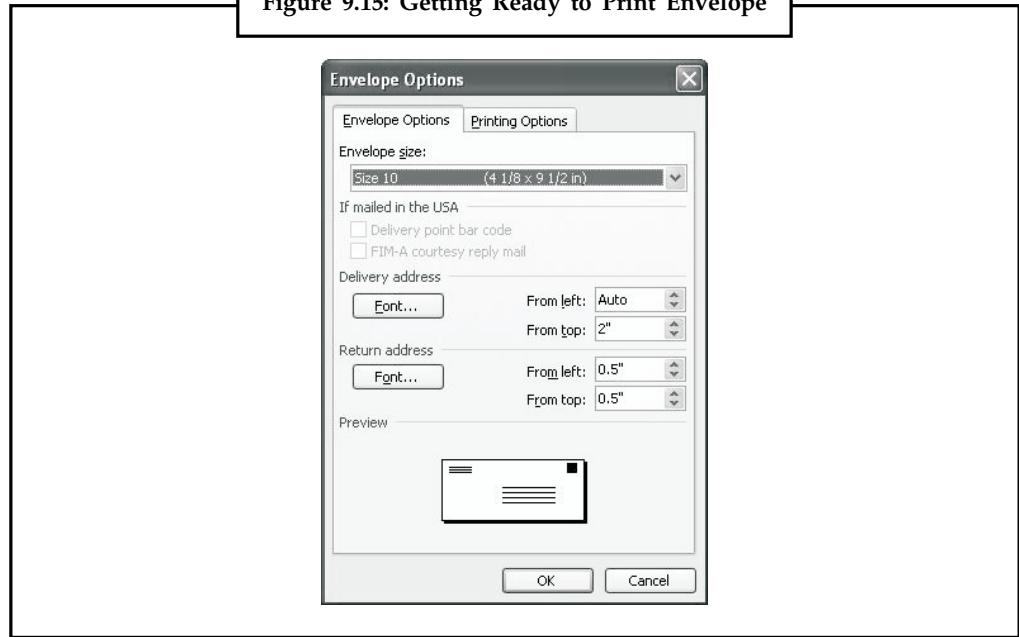

- In the Sort By list box, select the field by which records will be sorted.
- Choose the Ascending or Descending option according to the preference.
- Choose OK to return to the Merge dialog box.

Creating Envelopes and Mailing Labels

You can also use Word’s Mail Merge Helper to merge labels of various kinds and envelopes. The procedures to merge labels and envelopes are similar to that of form letters, we will discuss them only briefly here.

Using Mail Merge to Print Envelope

The steps you follow to print envelopes, using an already—existing data source document, are similar to those you use to create form letters except that the envelope is the main document.

Getting Ready to Print Envelope

Preparing to print envelopes is a matter of identifying the data source document, or creating one if it does not already exist, and selecting the envelope size and layout. To identify the data source document:

- Choose Tools >> Mail Merge.
- Choose Create >> Envelopes, and choose New Main Document.
- In the Mail Merge Helper dialog box, choose Get Data.
- To use the existing data source document, select Open Data Source. If you do not have one, choose Create Data Source.

Now to select an envelope size and layout:

- Choose Set Up Main Document to display the Envelope Options tab of the Envelope Options dialog box.

Printing the Envelopes

Notes

To print one or two sample envelopes:

- Choose Merge from the Mail Merge Helper button to display the Merge dialog box.
- In the Merge to list box, select Printer.
- Choose Merge button, to display the Print dialog box.
- Choose OK to print the envelopes.

Mailing Labels

The process of preparing and printing mailing labels is same as that of envelopes.

- Choose Tools >> Mail Merge.
- Choose Create >> Mailing Labels, and choose New Main Document.
- In the Mail Merge Helper dialog box, choose Get Data. Choose either existing data source document or create new data source document.

Figure 9.16: Mailing Labels.

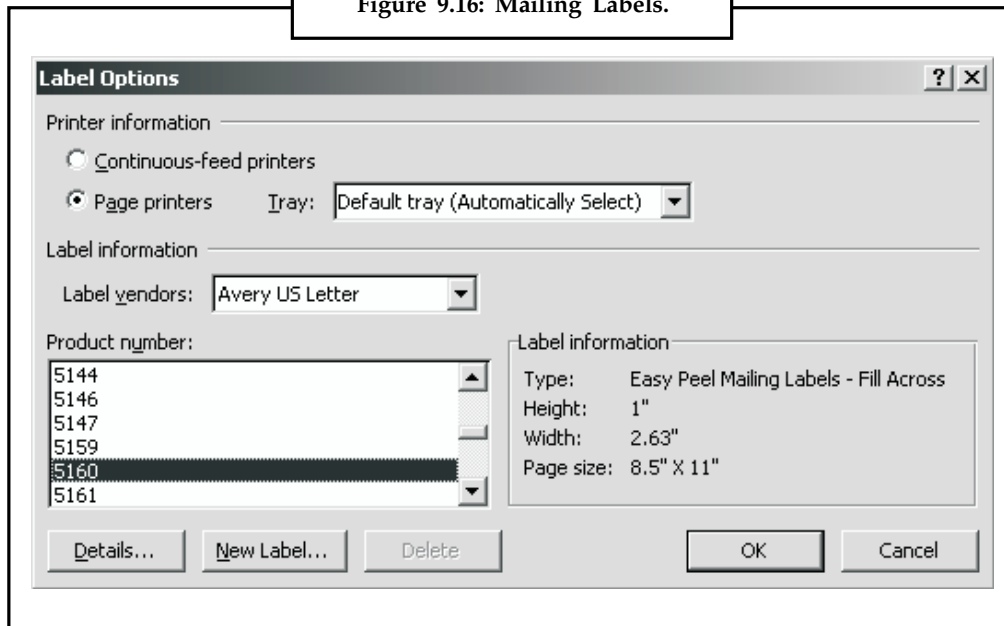

- Word will then invite you to setup your main document. Choose Set Up Main Document to display the Label Options dialog box.
- When you have chosen the labels to use, choose OK to close the dialog box.
- Word displays the Create Labels dialog box. Use the Create Labels dialog box to place merge fields from the data source document into the label.
- Choose OK to return to Mail Merge Helper, and then select to Edit the main document. Word will enter your label fields into the main document.
- To print labels, follow the same process of merging, checking, and printing labels as you did for envelopes.

*Case Study*

Overview of Creating a SmartArt Graphic

Most content that is created by using 2007 Microsoft Office system programs is textual, even though the use of illustrations improves understanding and memory and encourages action. Creating designer-quality illustrations can be challenging, especially if you are not a professional designer or you cannot afford to hire a professional designer. If you use earlier versions of Microsoft Office, you can spend a lot of time getting shapes to be the same size and to be aligned properly, getting your text to look right, and manually formatting the shapes to match the document's overall style, instead of focusing on your content. With the new 2007 Office release feature called SmartArt graphics, and other new features such as themes (theme: A set of unified design elements that provides a look for your document by using color, fonts, and graphics.), you can create designer-quality illustrations with only a few clicks of your mouse.

You can create a SmartArt graphic in Microsoft Office Excel 2007, Microsoft Office PowerPoint 2007, Microsoft Office Word 2007, or in an e-mail message in Microsoft Office Outlook 2007. Although you cannot create a SmartArt graphic in other 2007 Office release programs, you can copy and paste SmartArt graphics as images into those programs.

Applies only to Microsoft Office PowerPoint 2007

Because Office PowerPoint 2007 presentations often contain slides with bulleted lists, you can quickly convert slide text to a SmartArt graphic. In addition, you can add animation to your SmartArt graphic in Office PowerPoint 2007 presentations.

When you create a SmartArt graphic, you are prompted to choose a type of SmartArt graphic, such as **Process**, **Hierarchy**, **Cycle**, or **Relationship**. A type is similar to a category of SmartArt graphic, and each type contains several different layouts. After you choose a layout, it is easy to change the layout for your SmartArt graphic. Most of your text and other content, colors, styles, effects, and text formatting are automatically carried over to the new layout.

When you select a layout, placeholder text (such as [Text]) is displayed, so that you can see how your SmartArt graphic looks. Placeholder text is not printed, nor is it displayed during a slide show. However, the shapes are always displayed and printed, unless you delete them. You can replace the placeholder text with your own content.

As you add and edit your content in the Text pane, your SmartArt graphic is automatically updated — shapes are added or removed as needed.

You can also add and remove shapes in your SmartArt graphic to adjust the structure of the layout. For example, even though the **Basic Process** layout appears with three shapes, your process may need only two shapes, or it may need five shapes. As you add or remove shapes and edit your text, the arrangement of the shapes and the amount of text within those shapes is updated automatically—maintaining the original design and border of the layout for your SmartArt graphic. To quickly add a designer-quality look and polish to your SmartArt graphic, apply a **SmartArt Style** to it.

Contd...

Questions:

1. How is SmartArt graphic useful in present era?
2. What are the basic concepts of using SmartArt graphic in MS Word 2007?

Notes

9.5 Summary

- The MS Word give your documents a professional look using formatting options available in word 2000.
- Using character spacing feature of word it is possible to increase or decrease the amount of space between characters.
- In MS word text effects facility can be used to give a blinking background to the text.
- Using various buttons available on the formatting Toolbars, the font, font style, and front size can be changed.
- Wizards are easy to use program supplied with word that enable the user to create documents by answering a series of questions.
- A wizard creates a formatted documents for the user and prompts to include item the user may otherwise forget using a letter wizard, it is possible to create a letter by providing the recipients name, delivery address, sender's name, and return address.
- Template is just as a framework boilerplate or master pattern that defines documents, appearance and may define some of its contents.
- In the mail merge process, two main documents are used by word, a main document and a data source document.
- Using mail-Merge it is also possible to create and print envelopes and mailing tables.

9.6 Keywords

Clip Art: Clip Art is a graphic or picture. Clip Arts are available in many styles and formats.

Data Source: Data Source is also called the Data File. It stores information to be brought into the Main document. The data file table contains a column for each category of information, or data field, in the data file. The Header Row is the first row of the table. It contains field names, which indicate the type of information in each column.

Form Letter: Form letter is the resultant document of the mail merge operations, which contains the copy of the main document along with each piece of information stored in the data file.

Gutter Margin: A gutter margin is the white space formed by the adjoining inside margins of two facing pages in a book, or the space between columns on a page.

Main Document: In Mail Merge, Main Document is the common letter, which contains the common information for each of the merged document. It also contains the field names, which contain the instructions for carrying out the merge.

Page margins: Page margins are the blank space around the edges of the page. In general, you insert text and graphics in the printable area between the margins.

Notes

Sections: A portion of a document in which you set certain page formatting options. You create a new section when you want to change such properties as line numbering, number of columns, or headers and footers.

Section break: A mark you insert to show the end of a section. A section break stores the section formatting elements, such as the margins, page orientation, headers and footers, and sequence of page numbers.



Lab Exercise

1. What would you do if page numbering doesn't restart with each record in completed merge?
2. How do you amend, add or remove mail merge fields?

9.7 Self-Assessment Questions

1. Merge printing is used to generate multiple copies of the same document with personalized information on each copy.
(a) True (b) False
2. Mail merge feature of Word can be used to create greeting cards containing text and pictures.
(a) True (b) False
3. Data source contains the information that is to be sent to all the recipients.
(a) True (b) False
4. If errors occur during the mail-merge process, there is no way to correct those errors.
(a) True (b) False
5. Specific records of data source can be combined during the merge process.
(a) True (b) False

9.8 Review Questions

1. What would you do if page numbering doesn't restart with each record in completed merge?
2. How do you amend, add or remove mail merge fields?
3. If your email addresses aren't inserted as hyperlinks in the completed merge how would you do that?
4. What do you understand by Mail Merge?
5. Define the different components of Mail Merge.
6. How do you invoke 'Mail Merge Helper' window?
7. Differentiate between Merge and Query option of 'Mail Merge Helper' window.
8. How will you create a data source document?
9. How will you merge specific records of data source?
10. Briefly explain the process of preparing and mailing labels.

11. What is the difference between a hard page break and a soft page break?
12. What do you understand by hyphenating a document?
13. What type of text should be printed as headers and footers?

Notes

Answers for Self-Assessment Questions

1. (a) 2. (a) 3. (b) 4. (a) 5. (b)

9.9 Further Readings



Books

Fundamental Computer Skills, Feng-Qi Lai, David R. Hofmeister.

A Study of Computer Fundamental, Shu-Jung Yi.



Online link

<http://books.google.co.in/bkshp?hl=en>

Notes

Unit 10: Microsoft Excel

CONTENTS

Objectives

Introduction

- 10.1 Starting Excel
 - 10.1.1 Excel 2003
 - 10.1.2 The microsoft Excel 2007 Window
- 10.2 Exploring the Excel Window
 - 10.2.1 An Excel worksheet
 - 10.2.2 Using Office Assistant
- 10.3 Creating an Excel Workbook
 - 10.3.1 Saving Our Work
 - 10.3.2 Saving for the First Time
 - 10.3.3 Opening an Excel Workbook
 - 10.3.4 Opening a Workbook from Inside Excel
 - 10.3.5 Entering and Manipulating Data
 - 10.3.6 Entering and Formatting Titles
 - 10.3.7 Arranging Text with the Copy, Paste, and Cut Commands
- 10.4 Entering Data
 - 10.4.1 Doing Simple Calculations
- 10.5 Exploring Number Format
 - 10.5.1 Entering Dates
 - 10.5.2 Sorting Functions of Data
 - 10.5.3 Using Formulae and Different Standard Functions
 - 10.5.4 Copying Formulas
 - 10.5.5 Analyzing Data
 - 10.5.6 Sample Example Using Functions to 'Calculating Grades
- 10.6 Range of Cells
- 10.7 Formatting Cells
- 10.8 Excel Function
 - 10.8.1 Date and Time Function
 - 10.8.2 Financial functions
 - 10.8.3 Logical Functions
 - 10.8.4 Mathematical and Trigonometric Function

- 10.9 Summary
- 10.10 Keywords
- 10.11 Self-Assessment Questions
- 10.12 Review Questions
- 10.13 Further Readings

Objectives

After studying this unit, you will be able to:

- Discuss the starting of excel
- Explain the excel window in worksheets
- Discuss the creation of excel sheet and saving cash sheets in excel format
- Discuss entering of data and explore number format
- Explain the sort function and entering of dates
- Explain cells and formality of cells
- Discuss excel function, in date time, financial, logic, mathematical and trigonometric functions

Introduction

This application is one of the most useful tools to carry out most of the common scientific and statistical tasks in a faster way. The data once entered in to a worksheet can be manipulated to carry out many results and also using the same data or its output to plot a graph. This Application has a standard library of mathematical, scientific and statistical formulae and these facilities can be used to estimate the result. The following topics will describe how to use this application from first principles.

10.1 Starting Excel

10.1.1 Excel 2003

1. Click the **Start** button in the lower-left corner.

Figure 10.1: Starting Excel

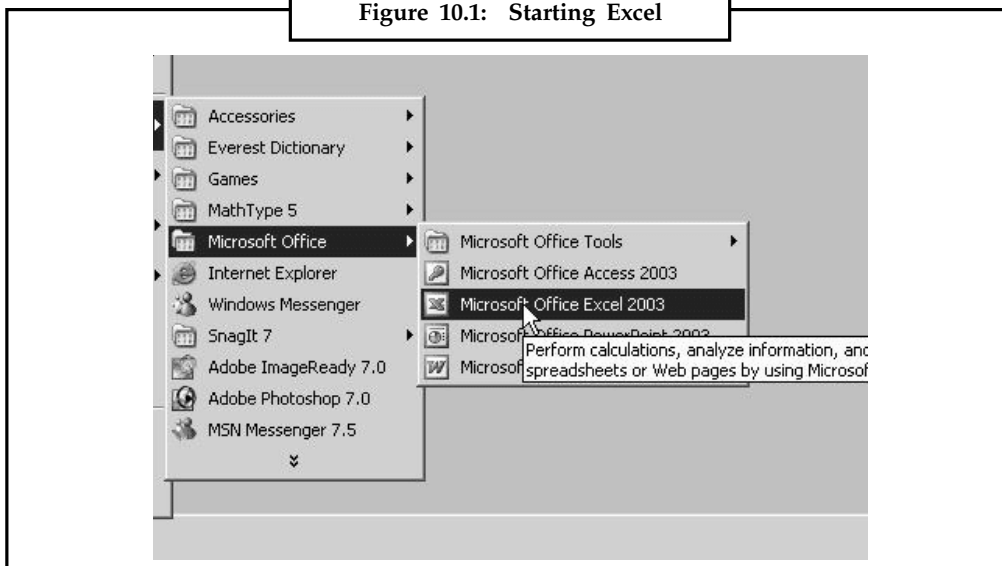

Notes

- 2. Position the mouse pointer on **Programs**.
- 3. Click **Microsoft Excel**.

10.1.2 The Microsoft Excel 2007 Window

If you have purchase a valid licensed copy of Microsoft Excel 2007 then open it following the instructions given below:

- 1. Go to Start → Programs → Microsoft Office → Microsoft Excel 2007

The Microsoft Excel 2007 window appears:

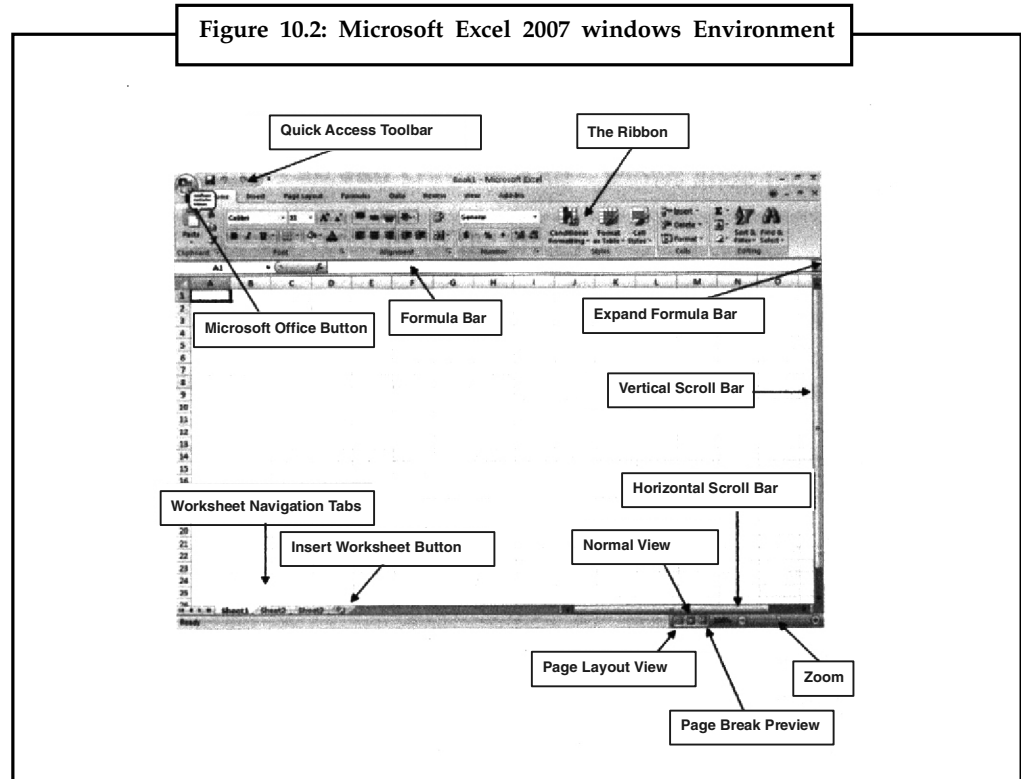

Screen always might not look exactly like the screen shown. In Excel 2007, display of window depends on the size of the monitor and the resolution to which the monitor is set. resolution determines how much information the computer monitor can display. A low resolution means less information fits on the screen, but the size of text and images are larger. Inversely, a high resolution means more information fits on the screen, but the size of the text and images are smaller. Also, settings in Excel 2007, Windows Vista, and Windows XP allow you to change the color and style of your windows.

10.2 Exploring the Excel Window

When we start working in Excel, we begin using a workbook that contains screens called worksheets. They are identified as Sheet 1, Sheet 2, and so on. As we become more familiar with the available options in Excel, we can customize the menus and add buttons to the toolbars just the same way as we did in M.S Word. Here is the initial screen we see when we open Excel Workbook.

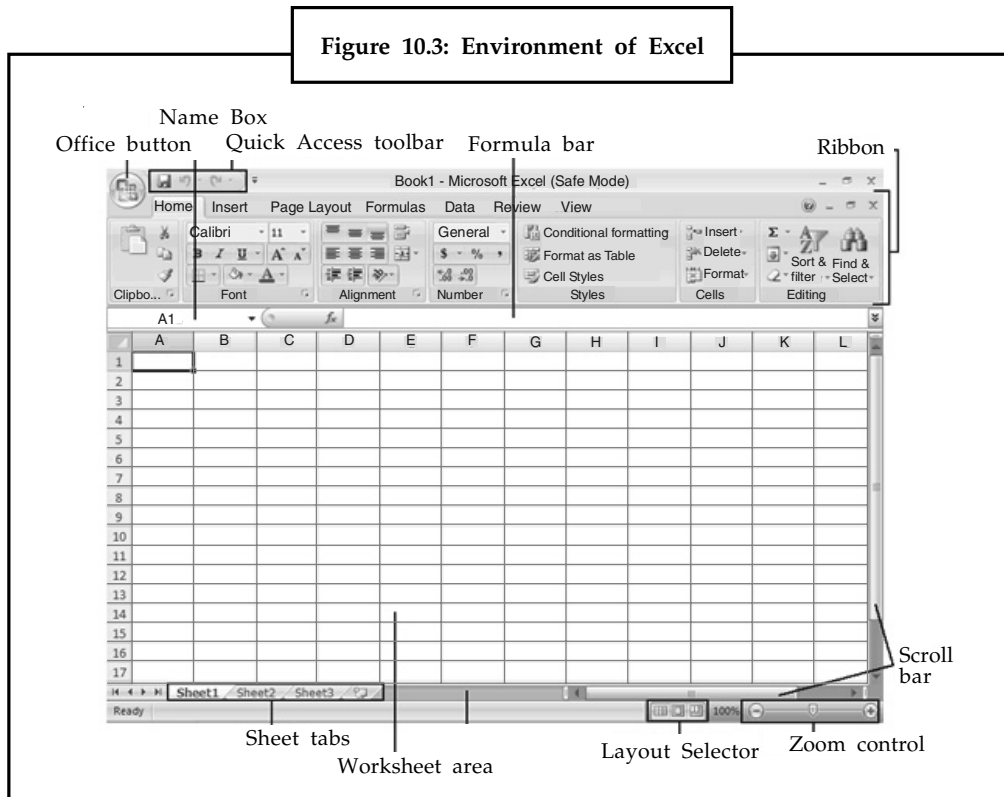

10.2.1 An Excel worksheet

An Excel worksheet as seen in Figure 10.2 looks like a grid pattern full of cells. Moving from one cell to another in Excel is quick and easy. Other ways to move from cell to cell include clicking a cell or using the **Go To** command, the scroll bars, the arrow key, or the home, end, page up, and page down keys.

- **Moving within a window**

- (i) To select any cell, click it. For example, click cell A1.
- (ii) To move one cell to the right, press tab, or to move one cell to the left, press shift+tab.
- (iii) To move one cell down, right, up, or left, use the arrow keys.
- (iv) To move to the first column of the worksheet, press home.

- **Moving from window to window**

- (i) To move one window down, press page down.
- (ii) To move one window up, press page up.
- (iii) To move to the uppermost-left cell, A1; press ctrl+home.
- (iv) To move to any cell, on the Edit Menu, click **Go To**, and type J 18 or any cell number.
- (v) Press ctrl+home to return to cell A1.

Notes

10.2.2 Using Office Assistant

Working with office assistant is a tricky affair and the productivity and usefulness of this facility depends on understanding the questions asked by the office assistant and answering them.

10.2.2.1 Working with Office Assistant Options

1. If the Office Assistant is not visible, click the question mark button on the Standard toolbar, and Office Assistant appears.
2. Presetting topics for assistance
 - (a) To display the **Office Assistant** dialog box, click anywhere in the Office Assistant image box.
 - (b) Click **Options**, and select the check boxes next to the options we want to present.
 - (c) Click **Reset my tips**, and then click **OK**.

- ❖ *Working with Office Assistant questions:* we can use everyday language to ask specific questions, and Office Assistant gives us a choice of available information.

- **Asking a specific question**

- ❖ To display the **Office Assistant** dialog box, click anywhere in the **Office Assistant** image box.
- ❖ Type workbook in the dialog box.
- ❖ Click **Search**.
- ❖ Click **About workbooks and worksheets**, and read the Help topic' that appears.
- ❖ Close the Help window.

10.3 Creating an Excel Workbook

The worksheets are used for numerous tasks such as to collect and analyze information, including records, notes, activity budgets, professional organization information, data, financial reports, nutritional diaries, and legislative voting records.

There is a difference between a workbook and a worksheet. A workbook can contain many worksheets. Each worksheet can contain up to 256 columns across and 65,536 rows down.

Following steps can be used to create an Excel workbook:

- (a) On the File menu, click **New**.
- (b) On the **General** tab, double-click **Workbook** to open a new one.
- (c) Click cell B2, and type Student List.
- (d) On the File menu, click **Save**, type Book 1, and click **OK**.

10.3.1 Saving Our Work

When we create a workbook, regardless of which method we use, we must save our work in a logical place in the computer. Just like filing a document in a file drawer, storing a

computer document requires some attention to how we name the document and where we place it so we can easily find it again.

Notes

Unless we specify otherwise, Excel saves all workbooks to a default folder in our computer called My Documents.

10.3.2 Saving for the First Time

When we save the file for the first time, we should name the file as descriptively but as briefly as possible. Sometimes, we will want to name it as a particular version, or as a type of workbook (i.e., Hostel Record V.1.2). Follow the following steps to save a new workbook:

- On the File menu, click **Save**.
- Click the Save As arrow, and choose a location for our workbook.
- In the **File name** box, type hostel Record.
- To save the workbook, click Save.

Figure 10.4: Saving for the First Time

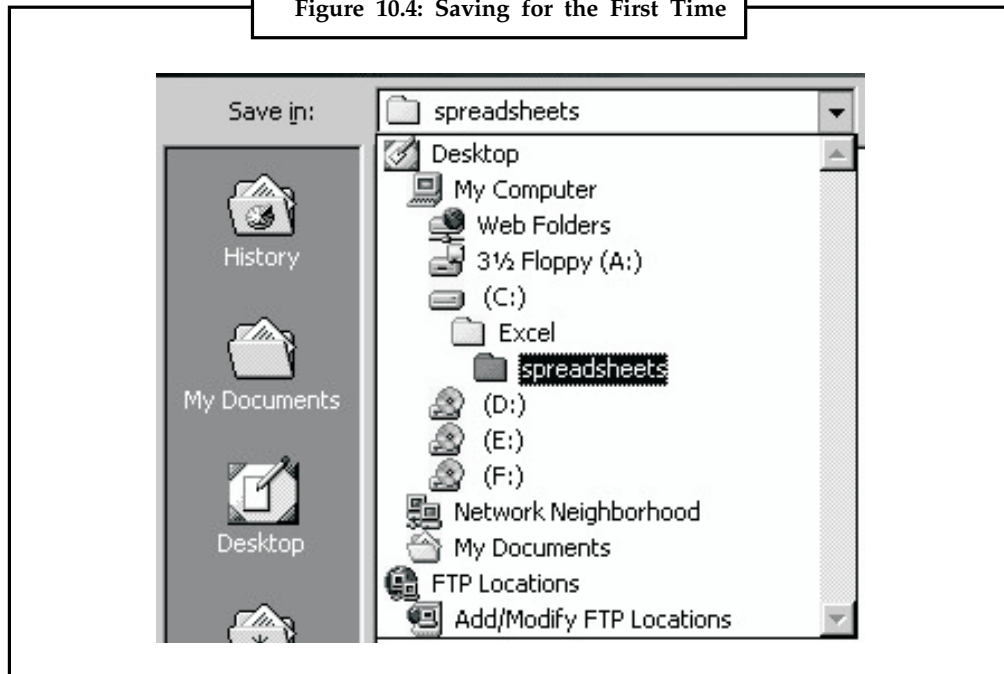

10.3.3 Opening an Excel Workbook

- Using the Start menu
 - ❖ Click the Start button on the desktop, and then move the mouse pointer to **Documents**. Click a file to open it.
 - ❖ On the File menu. Click **Close**, to close the workbook.

10.3.4 Opening a Workbook from Inside Excel

- On the **File** menu, click **Open**.
- Double-click **at the** file to open.
- Select the file name. and click **Open**.

Notes

10.3.5 Entering and Manipulating Data

Start a workbook either an existing one or a new. A new workbook can be started following the steps listed below:

Open a new worksheet.

On the **File** menu, click **Save As**.

Type "FirstFile" or any other file name or your choice. Click the **Save** button.

 Task	How to save file to specific place give the steps?
---	--

10.3.6 Entering and Formatting Titles

Using titles on the worksheets makes it easier to read and understand the information shown. We can retain the existing styles, create our own styles, or customize our own workbook template. The use of Title however is not necessary but it is always good to have them to enhance the readability and understandability of the data. The text and the titles etc. can be easily entered and modified much in the same way as that it is done in MS Word.

- With the First File worksheet open, move the pointer to cell E3, . type Amount, and then press enter.
- Click cell E3.
- On the Formatting toolbar, click the Font box, and click **NIS San Serif**. (%1e Mall have to use the down arrow next to the **Font** box to find Arial.)
- On the Formatting toolbar, click the arrow next to the **Font Size** box, click **14**, and then click the **Bold** button.

It has created the title "Amount Spent" as shown in the Figure 10.5 below.

Figure 10.5: Entering and Formatting Titles

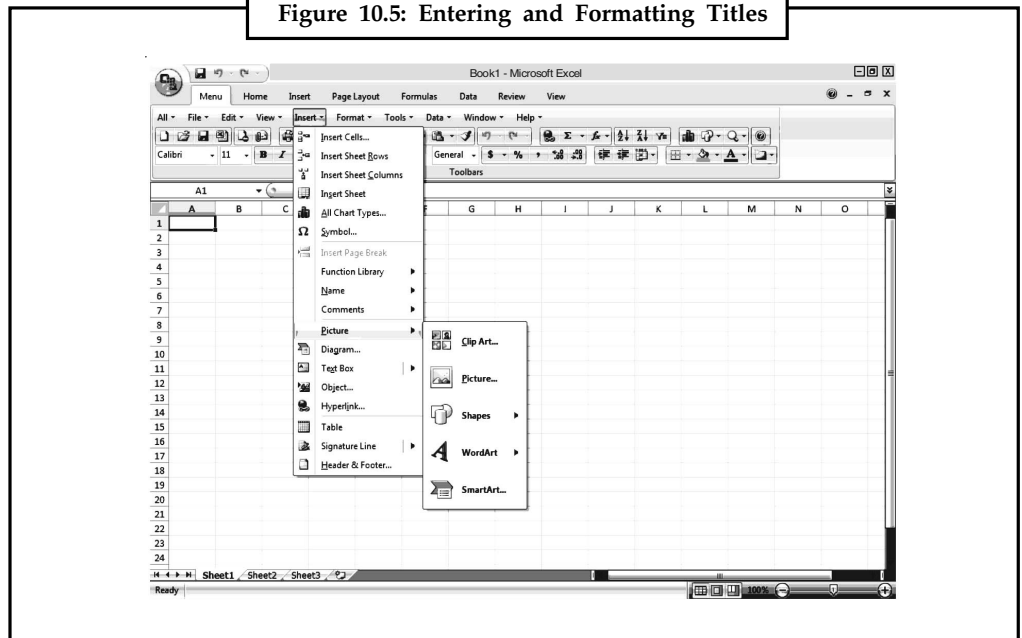

Column headings help in understanding the data or information that has been entered in the %worksheet. Sometimes the column heading is too large to fit into a column. Even though it does not show the entire title or formula, the cell still contains everything entered into it. This exercise, shows how to increase or decrease the column width to fit the entered information.

Notes

- Using the FirstFile worksheet, click cell B5, and type Dates in cell B5
- Press tab to go to cell C5, and then type Conveyance.
- Press tab to go to cell D5, and then type Miscellaneous.
- One cell will overlap the other.
- Press enter.
- At the top of the worksheet, position the pointer at the top of the grid between columns C and D until the pointer changes into a double-arrow line and then double-click.
- Note The pointer becomes a double-arrow! when it is placed between columns at the top of a chart.
- Repeat steps 4 and 5 between cells D and E.
- Select the words Amount Spew, and move the + pointer to a cell line until it changes to an arrow.
- Click and drag the text to begin in cell C3.
- Save the worksheet.

With these easy steps we can customize a template or design our own workbook to present our information.

10.3.7 Arranging Text with the Copy, Paste and Cut Commands

With Excel, it is easy to modify data. When we use the features in Excel to create a table, we may decide on a different order of column heads or we may want to revise them. It is important to make changes before we build a formula for the chart in order to maintain correct calculations.

Note Usually Cut is used to move the contents of a cell or cells to a different location. Copy is used to duplicate the contents of a cell or cells in another location.

- Using the Cut, Paste, and Copy commands to arrange text.
- Using the FirstFile worksheet, right-click cell C3, and click Cut.
- Right-click cell C1, and click **Paste**.
- Right-click cell D5, and click **Cut**.
- Right-click cell D10, and click **Paste**.
- Right-click cell C5, and click **Cut**.
- Right-click cell D5, and click **Paste**.
- Right-click cell D10, and click **Cut**.
- Right-click Cell C5, and click **Paste**.

Notes

- Try dragging cell C5 and cell D5 to new locations as we did in the previous exercise.
- Close the file without saving. **3.10.7**



Make sure never the copy more the one other wise only last copied is work and all data is lost.

10.4 Entering Data

Excel is a powerful package to enter and display data or text easily. For example, we can have Excel display a date showing the month, day, and year with the time, or showing only the first letter of the month, followed by a two-digit year. Numbers can be displayed as whole numbers, numbers with decimals, or numbers written in scientific notation.



When we enter data in a column format, we may find it easier and faster to use arrow keys to move between cells.

Entering data on expenditure under various heads:

- Open the FirstFile workbook.
- Starting in cell B6, type the following information into the worksheet, under the corresponding headings.

•

Dates	Conveyance	Miscellaneous
1/1/95	85	110
4/1/95	150	350
7/1/95	200	375
10/1/95	275	600
13/1/95	350	750
18/1/95	300	500
21/1/95	250	875

- Saving the file

10.4.1 Doing Simple Calculations

Notes

Using Excel 97, we can perform a wide range of mathematical calculations and function according to what we need from our data. To calculate sums (totals) and percentages. the mathematical operation of adding numbers to get a total, and then divide each number, that was just added by that total.

- Calculating the sum of schools with Web sites.
- In the technology workbook, click cell E5, type Total Sites, and press enter.
- Click cell E5 again, and on the Formatting toolbar, click the **Bold** button.
- Click cell E6, and on the Formula toolbar click the **Edit Formula** (the = sign).
- Click the **Functions** arrow, and choose **Sum**. (C6 : D6 appears in the H)
- Click OK.

To sum each pair of numbers, click E6 and drag the fill handle from E6 to Amount Spent

	Date	% on Conveyance	% on Miscellaneous	Conveyance Miscellaneous Total
6 j	1/1i95	85	110	195
7 !	4/1i95	150	350	500
8 ‘	7/1M	200	375	575
9 ;	10/1/95	275	600	875
10	13/1FJS	350	750	1100
11	1B/1FJ5	300	500	600
12;	21/1r95		875	1125
13				

Calculating the percentage of Expenditure on Conveyance

Click cell F5, type % of Conveyance, and then press enter.

Click cell F5 again, and then click the Bold button on the Formatting toolbar Click cell G5, type % of Miscellaneous, and press enter. Click cell G5 again, and on the Formatting toolbar click the **Bold** button.

- Click F6, and click the **Edit Formula** button (the = sign).
- Type C6/E6, and click OK.

Notes

- On the Formatting menu, click **Cells**. On the **Number** tab, choose **Percentage**, and then type 2 in the decimal places.
- Click F6, and drag the fill handle to F12 to calculate the percentage for each pair of numbers. Click **OK**.
- Repeat steps 3 through 8 for Secondary Schools using the formula D6/E6 to calculate the percentage.
- Save the worksheet, and close it.

10.5 Exploring Number Format

- Trying different number formats.
- Click cell B2, type 123456, press enter, and then click B2 again.
- On the Format menu, click Cells.
- On the **Number** tab, choose **Currency**. In **Decimal places**, click the down arrow until 0 appears, and then click OK.
- Click B2, in the Formula Bar, type . in front of 12345, press enter, right-click cell B2, and click Format Cells.
- Note Another way to change, format is to right-click the cell that we want to format. On that shortcut menu, click Format Cells.
- On the Number tab, under **Category**, click **Number**, under **Negative numbers**, click 1234 in red, and click OK.
- Close the workbook without saving changes.

10.5.1 Entering Dates

For displaying numbers as dates and formatting date cells follow the steps given below:

- Open the Technology workbook we created earlier.
- Right-click the B column header to select the dates and all of column B.
- On the shortcut menu, click **Format Cells**.
- On the Number tab, under **Category**, click **Date**.
- Under Type, choose 3/4/97.
- Click OK.
- On the File menu, click Save.
- Close the workbook.

10.5.2 Sorting Functions of Data

Recording names and addresses of students, preparing comparative statement of tenders etc are very lengthy and time consuming jobs. More so because the number of data items are large and intermittent addition of data requiring up dating the record. With Excel, sorting the data by name, by the date etc., is quick and easy. For example during preparing the student's records there are many details to track in a classroom, such as student data, grades, performance in seminar, student participation, homework, and other completed assignments.

Using Excel, we can track all this information for each student, and then organize it according to importance or category. Arranging names Alphabetically:

Notes

- Open a worksheet and record the data with column headings in cell A3.
 - ❖ Select the data table.
 - ❖ On the **Data** menu, click Sort.
 - ❖ Under **Sort by**, select **Name**, and then click **Ascending**.
 - ❖ Click OK.
 - ❖ The record has been sorted (refer figto•e-3.24)

S. N.	Name of Student	Entail Address	Seating
1	Rajeev Jain	pradip@redifmail.com	Row 2-3
2	Ashish Verma	Ashishjbp@yahoo_com	Rovv 2-1
3	Ratnesh Gupta	Rg1234@yahoo.com	Row 1-1
4	Akhilesh agrawal	Akhileshjabalpurit@yahoo.com	Row 1-3
5	Shirish Chile	Chile S a @mailcity.com	Row 1-2
6	Suresh Singh	tunnukomailgi@yahoo.com	Row 3-1
7	Anil Gupta	amnk@hotmail.com	Row 2-2
8	Satveer Singh	satveersinh@hotmail.com	Row 3-3
9	Vikas Nema	vnema a indiya.com	Row 3-2
10	Vipin Savla	vipinsavla@inetwala.com	Row 4-1

- Save the file with the name Student Records for use later. Close the workbook.

10.5.3 Using Formulae and Different Standard Functions

Excel has a library of standard functions used in financial, statistical, logical and other mathematical calculations. When the value of a cell has to represent the output of certain manipulation done on data using a function then the function can be called from the library and can be inserted by “insert Function command”. For doing this the cell where the function has to be put has to start with a “=” sign, followed by the insert/function/financial functions.

In case the function to use is difficult to locate then in the function category pan select all and then from the right pan find alphabetically.

Notes

Each time a function is selected, below the in bottom of the pans the function name, its format and description of the function is shown.

10.5.3.1 Order of Calculation in Excel

There are lots of formulae that help to calculate or analyze everything from finances to statistical sampling plans. When several formulae are combining, they are performed in a specific order. Excel starts calculating from the left to the right according to the following order or of operations:

- () Parentheses
- Negative number if used with one operand
- % Percentage
- ^ Exponentiation
- * and / Multiplication and division
- + and - Addition and subtraction
- Connects two text values to produce one
- Continuous text value
- =, <, <=, >, >=, <> Comparison operators

These **operands are explained in details by** clicking Office **Assistant**, and typing Operators.)r reference, the Comparison operators are:

- = Equal to
- < Less than
- = Equal to or less than
- > Greater than
- = Equal to or greater than
- <> Not equal to

10.5.4 Copying Formulas

Once a formula has been created, it can be quickly and easily copied into adjacent cells to calculate student records that contain the same type of data copying formulas

- Click the cell containing the formula to be copied select it.
- Click and drag the fill handle at the lower-right corner of the cell to the bottom of the column, and release the pointer.
- Save your file with the name Student List

10.5.5 Analyzing Data

Another Exciting feature of Excel is the hide column/row format. This is particularly useful analysis of data. Those details that is not required for the analysis can be hidden but not cease to exist, so that the visibility of the relevant data is increased.

10.5.6 Sample Example Using Functions to Calculating Grades

Notes

Grading of the students performance can be done very easily using excel. Suppose the students have been assessed by ten class test and their performance is graded by assigning **H grade** for marks between 90-100, **A grade** for 80-89, **B** for 70-79, **C** for 60-69 and students **less than 60** are fail i.e. **F grade**. We can chose the same weight age for all the test or it can vary. When we give different weigh ages then the performance index may be calculated by the formula (e.g. $0.4*Test1+0.1*Test2+0.05*Test3+ .$) or if the weight ages are equal then the performance index can be calculated by a simple average. For the following exercise it is an average.

- Hide column A, C and D.
- In cell M3, type Average Performance
- Move the pointer to cell M4, and on the Standard toolbar click Paste Function.
- Under the **Function category**, click Statistical; under Function name, select Average, and click OK.
- It asks for the cells of which the average to be calculated. Select E4-M-i and then Click OK to complete the function and average one row of grades.
- Click and Hold down the cursor at right-bottom of cell M4 and stretch it up to M 13.
- The average for all the students has been calculated.

Figure 10.6: Calculating Grades

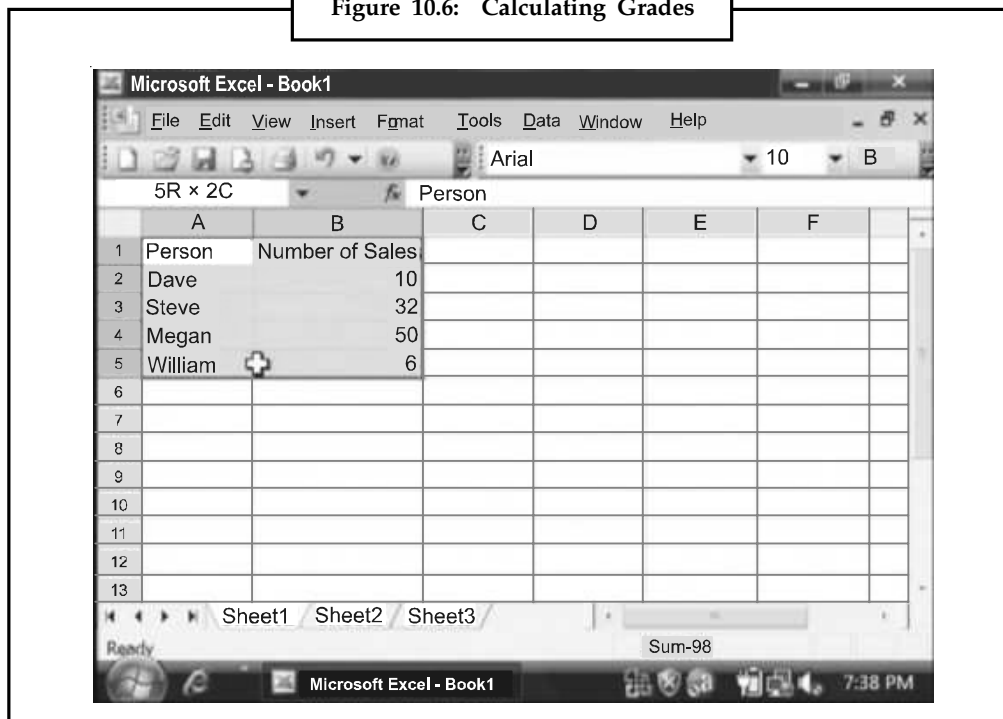

Notes

	A	B	C	D	E	F
1	ID	Name	Course	Marks	Grade	Status
2	1	Jack	Software Engineering	60	C	Pass
3	2	Billy	Requirement Engineering	90	A	Pass
4	3	Mcfaden	Multivariate Calculus	34	D	Fail
5	4	Steven Shwimmer	Software Architecture	96	A	Pass
6	5	Ruby Jason	Relational DBMS	70	B+	Pass
7	6	Mark Dyne	PHP development	34	D	Fail
8	7	Philip namdaf	Microsoft Dot Net Platform	78	B	Pass
9	8	Erik Bawn	HTMI & Scripting	87	A	Pass
10	9	Ricky ben	Data communication	78	B	Pass
11	10	Miecky	Computer Networks	89	A	Pass
12	11	Philip namdaf	Software Engineering	67	C+	Pass
13	12	Erik Bawn	Requirement Engineering	87	A	Pass
14	13	Ricky ben	Multivariate Calculus	56	D	Fail
15	14	Billy	Software Architecture	45	D	Fail
16	15	Mcfaden	Relational DBMS	34	D	Fail
17	16	Steven Shwimmer	PHP development	98	A	Pass
18	17	Philip namdaf	Microsoft Dot Net Platform	76	B	Pass
19	18	Erik Bawn	HTMI & Scripting	56	D	Fail
20	19	Erik Bawn	Data communication	99	A	Pass
21	20	Ricky ben	Computer Networks	89	A	Pass
22	21	Miecky	Requirement Engineering	78	B	Pass
23	22	Philip namdaf	Multivariate Calculus	67	C+	Pass
24	23	Ricky ben	Relational DBMS	87	A	Pass
25	24	Billy	PHP development	56	D	Fail
26	25	Mcfaden	Computer Networks	76	B	Pass

10.6 Range of Cells

- Open Excel from the Start menu.
- Choose your cell range. For example, highlight “F5” through “F28.” (Letters represent columns while numbers represent rows.) To highlight cells, just click and drag. To select a group of cells that are not touching, click each cell separately and hold down the “Ctrl” key.
- Click on the name box, which is directly above the “A1” cell.
- Type the new cell range name. For example, on a schedule, you might name all the time that you are commuting to work “Commuting.” Hit the “Enter” key.
- Use the cell range names in your next formula. These names can make your formulas much easier to use.

10.7 Formatting Cells

- Open your Excel worksheet and select the rows or columns you want to format. To select, hold down the left mouse button and drag.
- Click “Format” on the top menu bar to summon a list of options for formatting your worksheet.
- Click either “Row” or “Column.” The rows are horizontal, the columns are vertical.
- If you click “Row,” a box will appear. Enter the row height. If you pick “Column,” enter the column’s width in the designated box.
- When you’ve finished formatting, click “OK” and save your work.

10.8 Excel Function

Notes

In the function dictionary that follows, the most commonly used Excel functions are listed with their arguments. Function definitions are grouped by type and are listed in alphabetical order within each group. The function groups include the following:

- Database
- Lookup and Reference
- Date and time
- Mathematical and Trigonometric
- Financial
- Statistical
- Information
- Text
- Logical

The following sections explain some important functions of Excel.

10.8.1 Date and Time Function

Working with dates and times is a common worksheet task and Excel includes a rich set of date and time functions. First, it is important to understand how Excel works with date and time values.

Date and time values are numbers, regardless of how the cells are formatted. Dates and time are stored as serial numbers by default. Excel uses a 1900 date system in which serial numbers range from 1 to 65,380 corresponding to dates Jan 1, 1900 through Dec 31, 2078.

In the serial number, digits to the right of the decimal point representing time of day (as fraction of 24 hours); 12:00 A.M. is the equivalent of 0.

Today Returns the serial number of today's sheet.

Syntax : TODAY()

Date Returns the serial number of a particular date.

Syntax : DATE (year, month, day)

Year is the year number 1900 or larger.

Month is a number representing the month of the year.

Day is a number representing the day of the month.

Day Convert a serial number to a day of the month.

Syntax : DAY (serial_number)

Serial_number is the date_time code used by Microsoft Excel for date and time calculations.

NOW Returns the serial number of the current date and time.

Syntax : NOW ()

Notes

TIME

Returns the serial number of a particular time.

Syntax : TIME (hour, minute, second)

Hour is a number from '1 to 23 that represents the hour'

Minute is a number from 0 to 59 that represents the minute'

Second is a number from 0 to 59 that represents the second'



Example: TIME (13, 50, 27) returns 0.57670389, which is equivalent to 1:50:27 PM.

10.8.2 Financial Functions

Rather than typing financial equations, you can use Excel's financial functions' Excel provides a family of functions that solve annuity problems' An annuity is a series of regular cash flows over a Period of time.

FV:

Returns the future value of an investment'

Syntax: FV(rate, nPr, Pmt, Py type)

Rate is the interest rate per period' Nper is the total number of pay ment periods in an annuity' Pmt is the payment made each period'.

Pv is the present value, or the tump-sum amount that a series of future payments is worth right now. If pv is omitted, it is assumed to be 0.

Type is the number 0 or 1 and indicates when payments are due' If type is 0, payments are due at the end of the period; if type is '1' payments are due at the beginning of the period'.



Example: FV(0"5%, 10, -200, -500, 1) returns \$2581'40"
fV(11%12,35,-2000, , 1) returns \$82,846'25'

PMT:

Returns the periodic payment for an annuiry- based on constant payments and a constant interest rate'

Syntax: PMT(rate, nper, PV fv, type)



Example: The following formula returns the monthly payment on * \$10,000 loan at an annual rate of 8% that you must pay off in 10 month. PMT(8%12, 10, 1 0000) returns -\$1037'03'.

For the same loan, if payments are due at the beginning of the period, the payment is PMT(8%12,1A,10000, 0, 1) which return -\$1030.'16.

Returns the present value of an investment (the total amount that series af future paynrents is worth now). For example, when 'you borrow money, the loan amount is the present value to the lender.

Syntax:

PV(rate, nper, pmt, fV type)

10.8.3 Logical Functions

The logical functions are powerful worksheet functions that enable you to add decision-making and logical preferences to your worksheets results.

IF

Specifies a logical test to perform.

Syntax:

IF(logical_test, value_if_true, value_if_false)

Logical_test is any value or expression that can be evaluated to true or false.

Value_if_true is the value that is returned if logical_test is true.

Value_if_false is the value: that is returned if logical_text is false.

Up to seven IF functions can be nested as value_if_true and value_if_false arguments to construct more elaborate tests. The result values can display text with an argument such as "Hello", calculate a formula such as B12*6 or display the contents of a cell such as D35. Consider the following formula

`IF(B34>50, B34*2, "Entry too low!")`

In this example, the IF() function produces the answer 110 if B34 is 55.

If B34 is 12, however, the cell that contains the function displays the text given below.

Entry too low!

AND

The AND function joins test conditions. Returns TRUE if all its logical arguments are TRUE; returns FALSE if one or more logical arguments is FALSE.

Syntax: AND(logical1, logical2...)



Example: AND(TRUE, TRUE) returns TRUE.

AND(TRUE, FALSE) returns FALSE.

AND(2+2=4, 2+3=5) returns TRUE.

OR

Returns TRUE if any argument is TRUE.

Syntax: OR(logical1, logical2, ...)

Logical1, logical2, ... are 1 to 30 conditions you want to test that can be either TRUE or FALSE.



Example: OR(1+1=1, 2*2=5) returns FALSE.

If A1:A3 contains the values TRUE, FALSE and TRUE, then

OR(A1:A3) returns TRUE.

NOT

Reverses the logic of its argument.

Syntax: NOT(logical)



Example: NOT(FALSE) returns TRUE.

NOT(1+1=2) returns FALSE.

10.8.4 Mathematical and Trigonometric Function

Mathematical and trigonometric functions provide the foundation for the majority of worksheet calculations. Most scientific and engineering functions are found under mathematical functions.

ABS:

The ABS function returns the absolute value of a number.

Syntax: ABS(number) Number is the real number for which you want the absolute value.

Notes



Example: ABS(43) returns 43-43 is the absolute value of 43.

ABS(-105) returns 105_105 is the absolute value of -105.

CEILING

Rounds a number away from zero to the nearest integer or to the nearest multiple of significance.

Syntax: CEILINC(number, significance)

Number is the numeric value you want to round off.

Significance is the multiple to which you want to round off.



Example: CEILINC (2.5,1) returns 3.

CEILINC(0.234, 0.01) returns 0.24.

FLOOR

Rounds a number down to the level of significance that you specify.

Syntax: FLOOR (number, significance)

Number is the numeric value you want to round off.

Significance is the multiple to which you want to round off.



Example: FLOOR(2.5, 1) returns 2.

FLOOR(-2.5, -2) returns -2. Rounds a number down to the nearest integer.

Syntax: INT(number) Number is the real number you want to round down to an integer.



Example: INT(8.9) returns 8.

INT(-8.9) returns -9.

ROUND

Rounds a number to a specified number of digits.

Syntax: ROUND(number, num_digits)

Number is the number you want to round off.

Num_digits specifies the number of digits to which you want to round off the number.



Example: ROUND(2.149,1) returns 2.1.

ROUND(-1.475, 2) returns -1.48.

ROUND(21.5, -1) returns 20.

Returns a positive square root.

Syntax: SQRT(number)

Number is the number for which you want the square root"



Example: SQRT(16) returns 4.

SQRT(-16) returns #NUM!

SQRT(ABS(-16)) returns 4.

Adds its arguments.

Syntax: SUM(number 1, number 2, ...)

Number 1, number 2, ... are 1 to 30 arguments for which you want the sum.

Notes



Example: SUM(3, 2) return

SUM (A2:C2) return 50, if cells A2:C2 contain 5, 15 and 30.



Case Study

Massachusetts Technology Corporation (MTC)

MTC created a web-based system to manage the entire reporting and payment process. With the system, new contracts are requested by account representatives, managers approve or reject, and key parties are notified. Immediately after each speaking engagement, physicians request payment and expense reimbursement via a secure website. Required parties are notified of their need to approve or reject, and the system tracks the payment request each step of the way—from submission to approval to accounts payable to conclusion. At any point, parties can view the request status, thereby reducing the time needed to track down late or missed payments. No more sending invoices, manually entering data into Excel, searching for paper contracts, getting approval signatures from each manager, or manually requesting a check from accounts payable. As importantly, residents of states requiring reporting can visit a public website and search by provider name for payments made to them. From initiation to conclusion, it took MTC less than six months to design, develop and install the system. The web-database ensures regulatory requirements are met, saves time and effort via workflow and reporting, and eliminates redundant data entry.

Questions:

1. What is the purpose of MS excel in the document file?
2. How do use mathematical function in the excel sheet?

10.9 Summary

- In this unit we discussed about Microsoft Excel.
- Exploring the Excel Window, in which when we start working we begin using work is called worksheet.
- Creation of worksheet in which we can say the worksheet that worksheet are used for mummies tasks.
- Sorting functions of data, in which we record the menus and address of varies data.
- Excel function, must commonly used excel functions are used by grasped.
- Data and time function are stored as serial number by default.
- Logical function are powerful worksheet functions that enablers you to add decision making and logic preference to your worksheet.
- Functions that provide the foundation of the majority of worksheet calculations are mathematical and trigonometric function.

Notes

10.10 Keywords

Documents: A **document** is a work of non-fiction writing intended to store and communicate information, thus acting as a recording. Documents are often the focus and concern of business administration and government administration. The word is also used as a verb as “documenting” describes the process of making a document.

Excel Worksheets: The worksheets are used for numerous tasks such as to collect and analyze information, including records, notes, activity budgets, professional organization information, data, financial reports, nutritional diaries, and legislative voting records.

Format Cell: When you enter data into a cell in Excel, it is handled differently depending on what type of formatting you have assigned to the cell. For example, if you choose **Currency** formatting, Excel will automatically convert 3 into \$3.00; if you choose **Date** formatting, Excel would convert 3/1 to March 1, 2002; and if you choose **Percent** formatting, Excel would change 0.3 to 30%.

Office Assistant: The **Office Assistant** was a Microsoft Office feature to assist users by way of an interactive animated character, which interfaced with the Office help content. It used technology initially from Microsoft Bob and later Microsoft Agent, offering advice based on Bayesian algorithms. In Microsoft Office for Windows, it was included in versions 97 to 2003.



Lab Exercise

1. Make a table and find the average of mark column.
2. Make the table and use the Trigonometric function.

10.11 Self-Assessment Questions

1. All formula in Excel start with

(a) %	(b) +
(c) =	(d) -
2. You can use a function to combine text from two cells into one cell. But you can use an operator to do the same thing. Which operator is that?

(a) & (ampersand)	(b) = (equal sign)
(c) (space)	(d) All of these
3. Two common wildcard characters that Excel recognizes are

(a) * and ?	(b) < and >
(c) ^ and /	(d) . + and -
4. The divide symbol is

(a) /.	(b) D
(c) \.	(d))
5. The multiplication arithmetic operator is represented by which of the following symbols?

(a) ^.	(b) *.
(c) /.	(d) X

- Notes**
6. To add two cells (A1 and A2) together you use the following formula
 - (a) = A₁ + A₂
 - (b) = Add(A₁+A₂)
 - (c) = together(A₁:A₂)
 - (d) A₁ plus A₂
 7. To make a number in cell C1 10% smaller than the number in C3 you enter
 - (a) = C3*1.10
 - (b) + C3*110
 - (c) = C3%10
 - (d) = C3*.90
 8. On an excel sheet the active cell in indicated by ...
 - (a) A dark wide boarder
 - (b) A dotted border
 - (c) A blinking border
 - (d) None of these
 9. On an Excel sheet the active cell in indicated by
 - (a) A dark wide border
 - (b) A dotted border
 - (c) A blinking border
 - (d) None of these
 10. Using the F11 shortcut key to create a chart on chart sheet creates
 - (a) A default chart
 - (b) A 2-dimensional column chart
 - (c) A 2-dimensional bar chart
 - (d) A 3-dimensional line chart

10.12 Review Questions

1. What are some ways to use Excel?
2. How many rows and columns are there in an excel?
3. How many worksheets can an Excel workbook have?
4. What is the difference between Microsoft Excel and Microsoft Word?
5. What are the advantages of Microsoft Excel?
6. How do you explain a Microsoft Excel?
7. How much RAM is there in a Microsoft Excel?
8. How do you insert rows in an Excel sheet?
9. How many cells are there in a single Excel sheet?
10. What do you mean by naming a cell?
11. What are functions?
12. What are the advantage of using names?
13. What do you understand by Function Wizard?
14. What does it mean by Environment of Excel?
15. How do you create an Excel Worksheet?

Answers for Self-Assessments Questions

- | | | | |
|--------|---------|--------|--------|
| 1. (c) | 2. (a) | 3. (a) | 4. (a) |
| 5. (b) | 6. (a) | 7. (d) | 8. (a) |
| 9. (a) | 10. (b) | | |

Notes

10.13 Further Readings



Fundamental Computer Concepts, William S. Davis.

Fundamental Computer Skills, Feng-Qi Lai, David R. Hofmeister.



<http://books.google.co.in/bkshp?hl=en>

Unit 11: Operations of MS Excel

CONTENTS

Objectives

Introduction

11.1 Features

11.1.1 Excel Parts

11.2 Formulae

11.2.1 Tips for Working with Formulae

11.2.2 Linking Workbooks

11.2.3 Need to Link Workbooks

11.2.4 Creating External Reference Formula

11.3 Graph and Chart

11.3.1 Understanding Charts in PowerPoint

11.3.2 Adding a Chart

11.3.3 Modifying Your Chart

11.3.4 Selecting a Chart Type

11.3.5 Entering Data in the Datasheet

11.3.6 Inserting and Deleting Datasheet Rows and Columns

11.3.7 Formatting Datasheet Column Width

11.3.8 Formatting Datasheet Numbers

11.3.9 Including and Excluding Rows and Columns

11.3.10 Returning to the Presentation from the Datasheet

11.4 Design Corner: Using Chart Formatting Options

11.5 Printing

11.5.1 Change Header and Footer Information on Slides

11.5.2 Change Header and Footer Information on your Notes and Handouts

11.5.3 Delete Header and Footer Information from your Slides

11.5.4 Delete Header and Footer Information from your Notes and Handouts

11.6 Summary

11.7 Keywords

11.8 Self-Assessment Questions

11.9 Review Questions

11.10 Further Readings

Notes

Objectives

After studying this unit, you will be able to:

- Understanding of MS Excel features
- Discussion of Excel formulae
- Explanation of Graph and chart in Excel
- Understanding of Design corner
- Process of printing Excel sheet

Introduction

Excel is a Window-based spreadsheet created by Microsoft Corporation, US. It includes all standard features of a spreadsheet package like automatic recalculation, graphs, and functions. It also includes several advanced utilities like the facility to include other objects within a spreadsheet and pivot tables and form designing'.

Excel can be used for a variety of applications. It is commonly used to automate financial statements, business forecasts, inventory control, and accounting. The package provides statistical, financial and scientific functions. Therefore, Excel can be used in many scientific and engineering environments to analyze numeric data. Excel is currently the best-selling Windows spreadsheet.

11.1 Features

Excel is a feature-rich product that can be used at many different levels.

- **Multisheet files:** Excel's files (called workbooks) can consist of any number of separate sheets. The sheets can be worksheets, chart sheets, macro sheets, or custom dialog boxes. This feature makes it easy to organize the user's work.
- **Multiple document interface:** This capability of Excel makes it easy to transfer information between worksheets in different workbooks.
- **File compatibility:** Excel can read files produced by other spreadsheet programs. It can also read text files, dBASE files, and HTML documents.
- **Interactive help:** While working in Excel, the user can get help on-screen. Excel's on-line help is excellent and extremely detailed.
- **List management:** This feature makes it easy to sort, filter, summarize, and manipulate data stored in the worksheet.
- **Built-in functions:** Excel includes an enormous collection of built-in functions.
- **Great charts:** Excel's charting features enable the user to modify and augment a wide assortment of graph types.
- **Integrated mapping:** This feature lets the user display the data in terms of a geographic map.
- **Pivot tables:** Using this feature, the user can view the data in summarized table form.
- **Advanced analytical tools:** Goal seeking, a powerful Solver feature, and the analysis .ToolPak add-in features, provides extensive statistical, financial, engineering, and scientific functions and procedures.

- **Scenario management:** Excel is often used for what-if analysis, that is, you can change one or more assumptions and observe the effects on dependent formulas.
- **Templates:** Excel has a template wizard that walks the user through the steps required to create a custom template.
- **Internet support:** Excel includes a variety of new features that make it easy to access Internet documents, save document as HTML files and even create hyperlinks directly in spreadsheet documents.

Notes

11.1.1 Excel Parts

- **The Title Bar:** This identifies the name of the program and also holds some control buttons, which can be used to modify the window.
- **Windows control menu buttons:** There are three buttons which control the application window: minimize, restore, and close.
- **Menu bar:** One way of issuing Excel commands is through the Menu bar.
- **Toolbars:** It holds buttons to issue commands when clicked.
- **Formula bar:** Information and formulas when entered into Excel, appear in this line.
- **Name box:** Displays the name of the active cell in the current workbook. It is also used to quickly give a name to the selected range or cell.
- **Status bar:** It usually contains mode indicator button and keyboard mode buttons.

11.2 Formulae

Formulae provide the real power while doing analysis and modeling—creating functioning spreadsheet systems—in Excel. By using formulae, entering a number into a single cell can cause a ripple effect throughout a complex model. A formula entered into a cell can consist of any of the following elements.

- Operators such as + (for addition) and * (for multiplication).
- Cell references
- Values
- Worksheet functions (such as SUM or AVERAGE)

Formulae in Excel share some basic properties

- All formulae begin with an equal sign (=).
- After a formula is entered, the resulting value is displayed in a cell.
- When a cell containing a formula is selected, the underlying formula is displayed in the formula bar.

Here are a few examples of formulae

$$= 150 * 5.0$$

$$= A_1 + A_2$$

$$= \text{SUM}(A_1 : A_3)$$

$$= A1 = C1$$

$$= (B_1 - B_3) * 50$$

Notes

Operators in Excel

Excel lets you use a variety of operators in your formulas. Table below lists the operators that Excel recognizes.

Excel's Built-in Functions

Excel provides a bewildering number of built-in worksheet functions that can be used in formulae. These include common functions such as SUM, AVERAGE, and SQRT as well as functions designed for special purposes such as statistics or engineering.

Using the AutoSum Tool

The Sum function is probably the most often used function and the AutoSum tool makes it very easy to enter SUM function onto worksheet. Let us consider the following example:

- Enter the following data into a blank worksheet.
- Select cell A5.
- Click on the AutoSum tool on the Standard toolbar.
- Press J (or click on the Enter box in the formula bar).

Entering Formulae

You can enter formulae in cells in the same way as you enter normal data values. There are basically two ways to enter a formula into a cell : Enter it manually or enter it by pointing to cell references.

Entering Formulae Manually

- Select the cell in which you want the formula to be located and begin typing.
- Simply type an equal sign (=) followed by the formula.
- Use all the normal editing keys while a formula.

Enter Formula by Pointing

To enter the formula =A1+A2 into A3, follow these steps:

- Move the cell pointer to cell A3
- Type an equal sign (=) to begin the formula.
- Click on cell A1.
- Type a plus sign (+).
- Click on cell A2.
- Press Enter to end the formula

Excel includes the Formula Palette feature that the user can use while entering or editing formulae. To access the Formula Palette, click on the Edit Formula button in the edit line.

Reference Operators

Formulae can refer to cells in other worksheets. Excel uses a special type of notation to handle types of references.

Cells in other Worksheets

Notes

To use a reference to a cell in another worksheet in the same workbook, use the following format

= Sheet Name! Cell Address



Example: = A5 * Sheet2 ! A5

Here is a formula that refers to a cell on a sheet named All Depts

= A5 *'All Depts' ! A5

Cells in Other Workbooks

To refer to a cell in a different workbook, use the following format

= [Workbook Name] Sheet Name ! Cell Address



Example: = [Employee.xls] Sheet 4 ! A2

If the Workbook name in the reference includes one or more spaces, enclose it in a single quotation marks.



Example: = A2 * '[Employee PF] Sheet1' ! A2

11.2.1 Tips for Working with Formulae

- Don't Hard Code Values Use cell references or named constant rather than constant values. Doing so makes it easier to modify and maintain the worksheet.
- Using the Formula Bar as a Calculator To perform a calculation. use the formula bar as a calculator. You might prefer to store the formula's result rather than the formula. To do so, press F9 followed by Enter. Excel stores the formula's result rather than the formula.
- Making an Exact Copy of a Formula When you copy a formula, Excel adjusts its cell references when you paste it to a different location. Sometime you may want to make an exact copy of the formula. Here's a step-by-step example of how to make an exact copy of the formula in A1 and copy it to A2.
 - ❖ Double-click on A1 to get into edit mode.
 - Drag the mouse to select the entire formula.
 - Click on the Copy button on the Standard toolbar.
 - Activate cell42.
 - Click on the Paste button to paste the formula into cell42
 - Press Enter to edit mode. This copies the selected text to the Clipboard.
- Converting Formulae to values Assume that range A1:A20 contains formulae that have calculated a result and that will never change. To convert these formulae to values:
 - ❖ Select A1:A20.
 - ❖ Click on the Copy button.
 - ❖ Select the Edit >> Paste Special command. Excel displays the paste Special dialog box.

Notes

- ❖ Click on the Values option button and click on OK.
- ❖ Press Enter or Esc to cancel paste mode.

11.2.2 Linking Workbooks

Linking is the process of using references to cells in external workbooks to get data into your worksheet. Linking enables one workbook to share the data in another workbook.

Link object can be one cell, a range of cells, and a named formula or constant, and sheets. The workbook containing the original data—the source of the information—is the ‘source workbook’. The workbook that receives the linked data is the ‘target workbook the source workbook need not be opened when you are working with the target workbook.

11.2.3 Need to Link Workbooks

The real value of linking is apparent when the source workbook is continually being updated. The user always has access to the most recent information. Linking workbooks can also be helpful if the user needs to consolidate different files. Linking is also useful as a way to break up a large model into smaller files. Linked data can be formatted by using the same formatting techniques the user use on any cell contents.

11.2.4 Creating External Reference Formula

There are several ways to create an external reference formula

- Manually typing the cell references.
- Standard pointing techniques, if the source workbook is open.
- Use the Edit >> Paste Special command with the paste Link button. This also requires that the source workbook be open.

11.3 Graph and Chart

PowerPoint charts can be as simple or as complex as you like. You can create a basic chart right inside PowerPoint using Microsoft Graph, or you can create a full-featured chart using Microsoft Excel and insert it into your presentation. You can choose from common chart types such as column, bar, line, and pie charts; try something out of the ordinary such as a doughnut or radar chart; or create a chart type of your own. PowerPoint charts are preformatted based on the attached design template, but you can also change nearly every aspect of a chart—its color, text, labels, and more.

A chart, also referred to as a graph, can be a useful tool for communicating numeric information in a concise format. You could create a chart illustrating sales revenue per region or the percentage of sales allocated to each of your products, for example. As you begin to work with charts, you’ll discover a multitude of uses for them.

11.3.1 Understanding Charts in PowerPoint

You can use Microsoft Graph to create charts in your presentation, or you can insert charts created in another application, such as Excel. Using Microsoft Graph inside PowerPoint is the easiest way to create a graph, but doesn’t offer any calculation or formula capabilities for your chart data. If you have already created a chart in Excel or you need to analyze complex data, it’s best to insert an Excel chart.



Notes

For the sake of consistency, we use the term chart throughout this chapter to match PowerPoint's interface—even though the application you use to create charts is called Microsoft Graph. Essentially, chart and graph are synonyms for any kind of graphical representation of numeric information.

Notes

Before you start creating a chart using Microsoft Graph from within PowerPoint, you should become familiar with chart terminology. Table 11.1 lists these terms and their definitions.



Did u know?

The most powerful aspect of Excel is not the simple calculator abilities, but rather the ability to take values from cells to be used in your formulas.

Table 11.1 Chart Object Terminology

Term	Definition
Axis	A line that frames one side of the plot area. The two most common axes are the value axis and the category axis.
Datasheet	A grid that resembles a spreadsheet, in which you can enter data for your chart.
Data label	Text that describes a specific data marker or series of data markers. This can be a numeric value, text, a percent, or a combination of these items.
Data marker	A value that represents a single cell or data point in a datasheet.
Data series	The main categories of information in a chart—usually reflected in a chart's legend and in the first cell of each datasheet row or column.
Data table	A grid in the chart that lists the exact data in the datasheet.
Gridlines	Lines that display across the category or value axes to make a chart easier to read. By default, major gridlines are in increments of 10 and minor gridlines in increments of 2.
Legend	A box that lists and color-codes all data series.
Trendline	A line that forecasts future values based on current data.

Figure 11.1 shows some of these chart objects.

Notes

Figure 11.1: Learn the Basic Objects of a Chart before You Create One

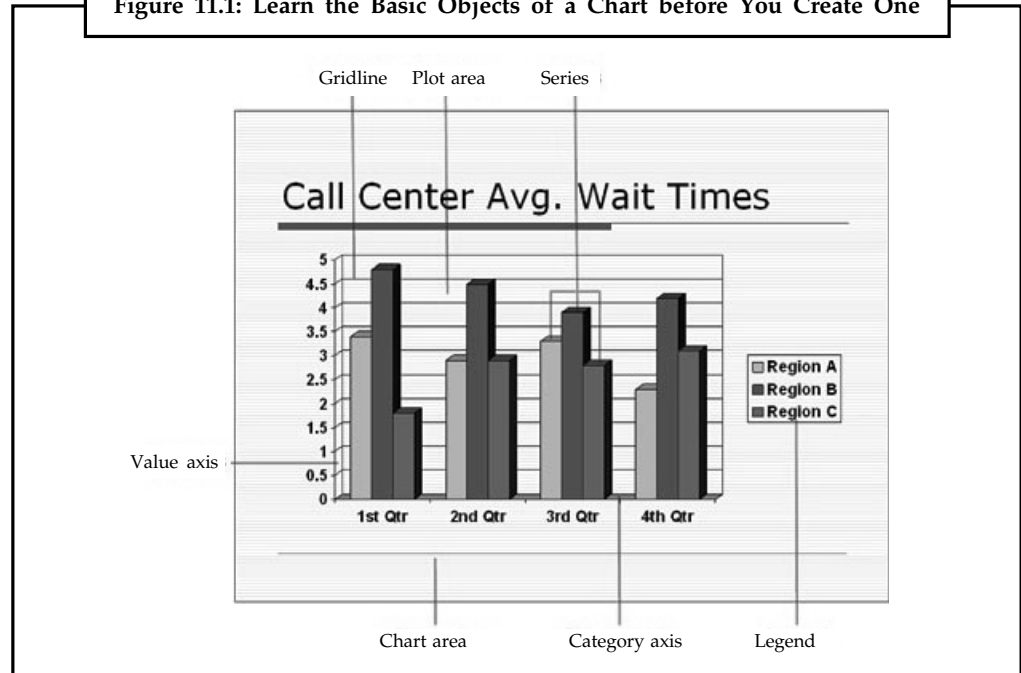

11.3.2 Adding a Chart

The fastest way to add a chart to your presentation is to add a slide and apply a layout that contains a chart. To do so, click the New Slide button on the Formatting toolbar and then choose a layout from the Slide Layout task pane. The next step varies depending on the slide layout you choose.

If you choose any of the layouts in the Content Layouts or Text and Content Layouts sections, you need to click the Insert Chart button on the content palette that displays (see Figure 11.2) to activate the chart and Microsoft Graph.

Figure 11.2: Click the Insert Chart Button to Start Creating a Chart

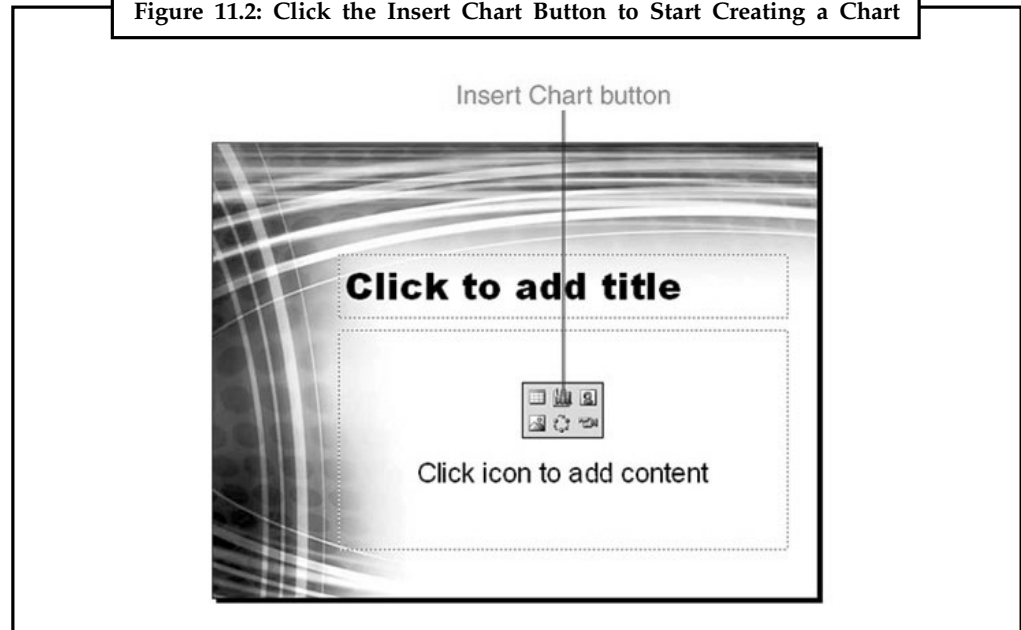

If you choose one of the layouts containing a chart in the Other Layouts section, you need to double-click the chart placeholder to activate the chart and Microsoft Graph. Figure 11.3 shows a sample chart slide with a chart placeholder.

Notes

Figure 11.3: You can Start Adding a Chart by Double-clicking the Placeholder

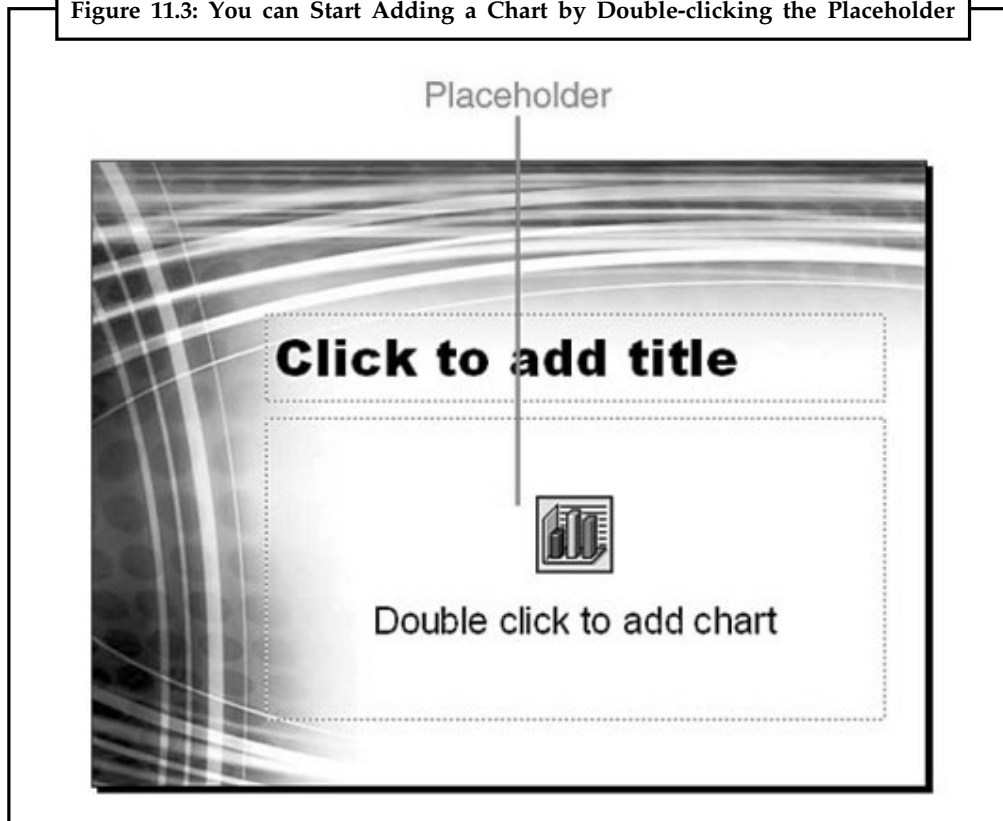

Did u know?

A chart gets your point across—fast. With a chart you turn worksheet data into a picture, where you can make a comparison or trend visible at a glance.



Notes

- (i) If you want to create a slide with a single chart and no other content, choose the Title and Chart slide layout.
- (ii) If you use the AutoContent Wizard to create your presentation, it might already have a slide that contains a chart.

To learn more about how slide layouts affect your presentation, see “Understanding Slide Layouts” in Unit 2, “Creating a Basic Presentation.”

You can also insert a chart into an existing slide by clicking the Insert Chart button on the Standard toolbar or by selecting Insert, Chart.

Figure 11.4 shows what you see after you click the Insert Chart button on a content palette or double-click a chart placeholder. A sample 3D clustered column chart appears, and the

Notes

related datasheet opens. The menu bar and toolbars are also customized for Microsoft Graph. The menu bar now includes Data and Chart menu items, and the Standard toolbar includes several new options, explained in Table 11.2.

Figure 11.4: PowerPoint Displays a Chart with Sample Data

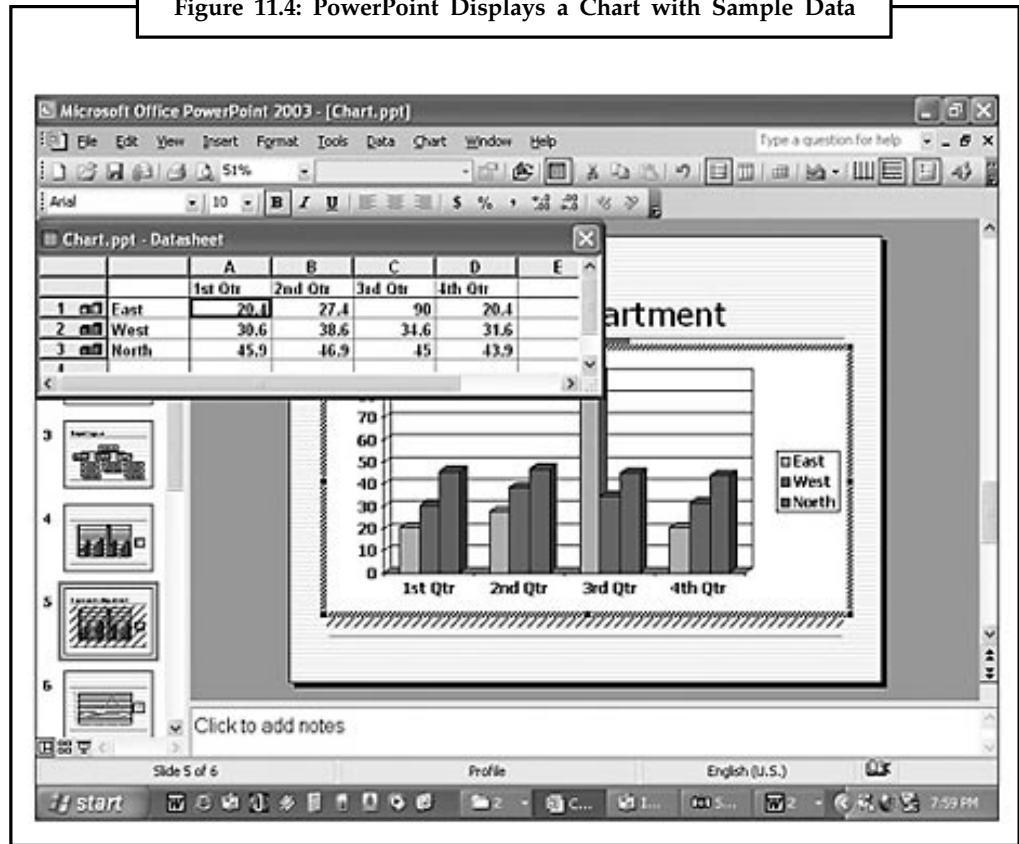

To learn more about object-formatting options in PowerPoint, see “Using the Format Dialog Box” “Creating and Formatting Objects,”











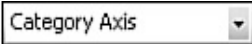

If you don’t see these menu and toolbar options, Microsoft Graph isn’t active. To activate it, double-click the chart in PowerPoint and you’ll then be able to view the Data and Chart menus and chart toolbar options.



Many of these toolbar buttons act as a toggle. For example, clicking the View Datasheet button displays the datasheet if it’s closed, but closes it if the datasheet already displays.

To determine what each object is in a chart you’ve created, place the mouse on that object or part of the chart and a chart tip displays its name. Figure 11.5 shows an example of a chart tip with the name and numeric value for a data series.

Table 11.2 Standard Toolbar Chart Options

Button	Name	Description
	Chart Objects	Lets you select a chart object such as a plot area, a chart area, a legend, an axis, or a series.
	Format	Opens a Format dialog box tailored to the selected chart object.
	Import File	Opens the Import File dialog box from which you can import chart data from another file, such as an Excel worksheet, into your chart.
	View Datasheet	Displays the chart's datasheet.
	By Row	Displays datasheet row data as the data series (the default).
	By Column	Displays datasheet column data as the data series.
	Data Table	Displays a table with all the datasheet data in your chart.
	Chart Type	Lets you apply a new chart type from a palette that appears.
	Category Axis Gridlines	Displays category axis gridlines.
	Value Axis Gridlines	Displays value axis gridlines.
	Legend	Displays a legend on your chart.
	Drawing	Displays the Drawing toolbar.
	Fill Color	Lets you apply fill color and fill effects to selected objects.

Notes

Figure 11.5: This Chart tip Lets you Know the Name of the Chart Object as well as its Value

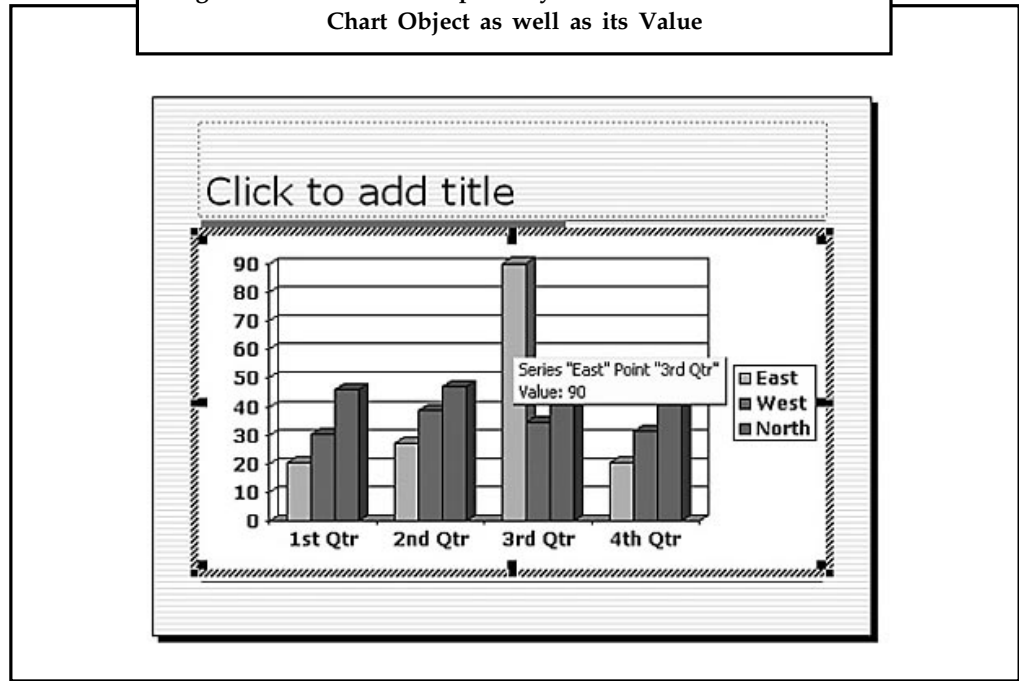

If the chart tip doesn't display, activate Microsoft Graph by double-clicking the chart, choose Tools, Options, and then verify that the Show Names and Show Values check boxes are selected on the Chart tab of the Graph Options dialog box (see Figure 11.6).

Figure 11.6: PowerPoint Displays Names and Values in Chart tips by Default

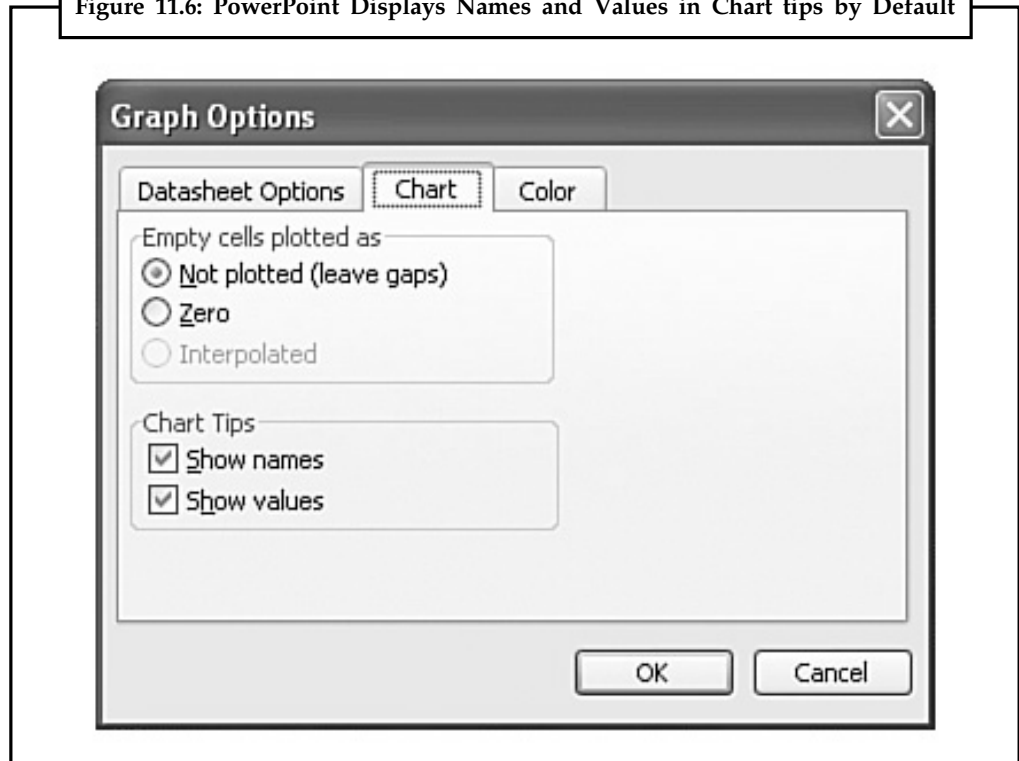

11.3.3 Modifying Your Chart

Notes

You can quickly create a basic chart, and you can make numerous enhancements and formatting changes. After you activate Microsoft Graph to create a chart, it's easiest to proceed in this order:

1. If you don't want a 3D column chart, change the chart type.
2. Type the text and numbers for your chart in the datasheet.
3. Type a title for the chart slide.
4. Modify and format chart objects as needed.



Notes

- (i) Before creating an actual chart, design a paper sketch of the chart you want to create. This can help you understand which chart type is right for your specific chart.
- (ii) For help in using Microsoft Graph, choose Help, Microsoft Graph Help. This opens the help file specific to this application.

11.3.4 Selecting a Chart Type

PowerPoint offers plenty of chart types and sub-types for almost every kind of graphic representation you could want to create. Sub-types are variations on a basic chart type, such as 3D options. PowerPoint includes these basic chart types:

- **Column:** Creates vertical columns to compare the values of categories of data. Column, bar, and line charts work well if you want to compare values over time periods such as months or quarters. Figure 11.7 illustrates a sample column chart.

Figure 11.7: A Column Chart Makes it Easy to Compare Series of Data

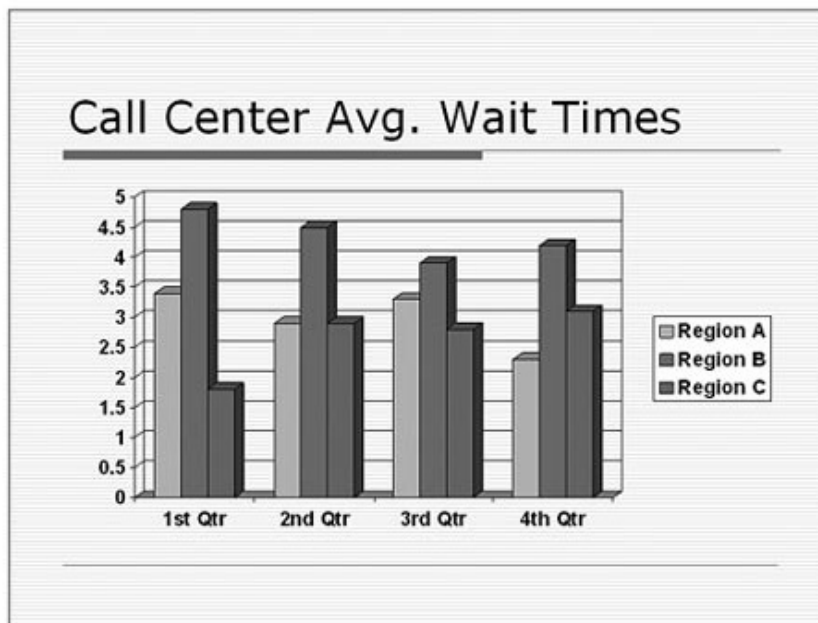

- **Bar:** Creates horizontal bars to compare the values of categories of data.
- **Line:** Creates a line with markers for each data value.

Notes

- **Pie:** Creates a pie that analyzes percentages of a total number. Use a pie chart to see how items contribute to a total. For example, you might want to compare the year's expenses for each department in your company. Figure 11.8 shows a pie chart.

Figure 11.8: Use pie Charts to Show Percentages of a Total Amount

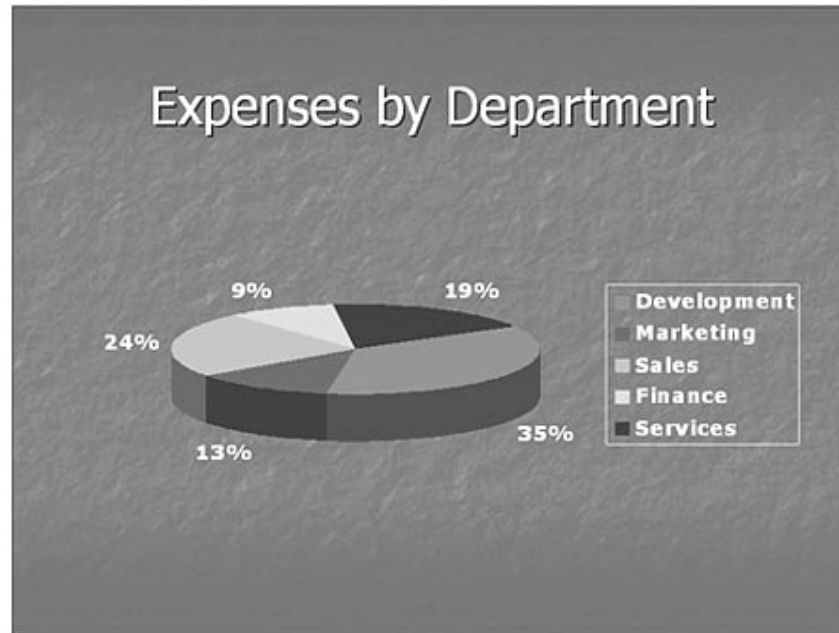

- **XY (Scatter):** Creates a chart that compares sets of values.
- **Area:** Creates a chart that shows the trend of values in a single solid area.
- **Doughnut:** Creates a pie chart that can contain more than one series.
- **Radar:** Assigns a value axis (radiating from the center) for each category, and draws lines to connect all values in the same series. The chart compares the collected values of several data series.
- **Surface:** Creates a single 3D surface that helps you finding the best combinations between two sets of data. Colors and patterns indicate areas that are in the same range of values.
- **Bubble:** Compares three sets of values displayed as bubbles.
- **Stock:** Shows a stock's high, low, and close figures.
- **Cylinder:** Creates columns shaped like cylinders.
- **Cone:** Creates columns shaped like cones.
- **Pyramid:** Creates columns shaped like pyramids.

If you already know that you want to create a 3D clustered column chart, which is the PowerPoint default, you don't need to do anything to select a chart type. However, if you want to use a different chart type, you should select it before you enter any data or make

any other modifications. There are two ways to change the chart type in PowerPoint. You can click the down arrow next to the Chart Type button on the Standard toolbar and select the chart type you want to apply from the palette that appears. Place the mouse over a specific chart type to view a chart tip that tells you the chart type's name. PowerPoint applies the chart type to your chart, which reformats itself in the new type. Not all chart types are available through the Chart Type button, however. If you can't find what you need on the palette that appears, try the Chart Type dialog box (Chart, Chart Type).

In either case, if you don't like the new chart type you applied, click the Undo button on the Standard toolbar to return to your original selection.

To apply a new chart type using the Chart Type dialog box, follow these steps:

1. In Microsoft Graph, choose Chart, Chart Type from the menu. The Chart Type dialog box appears, as shown in Figure 11.9.

Figure 11.9: PowerPoint offers many Different Chart Types

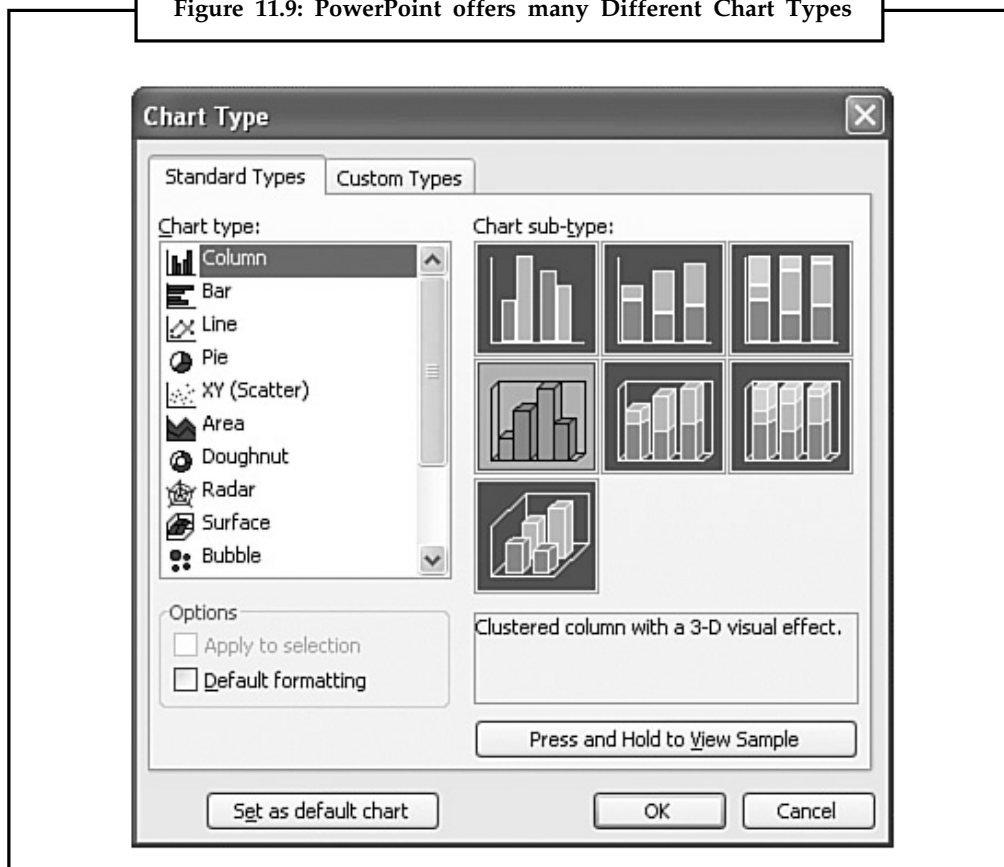

2. On the Standard Types tab, select the type of chart you want from the Chart Type list. A variety of sub-types appears in the Chart sub-type area.
3. Click the sub-type you want. The text box below provides detailed information about this sub-type.
4. To preview what an actual chart of this type looks like, click the Press and Hold to View Sample button. A sample chart temporarily replaces the Chart Sub-Type box, as shown in Figure 11.10.

Notes

Figure 11.10: You can Preview Changes before Making Them

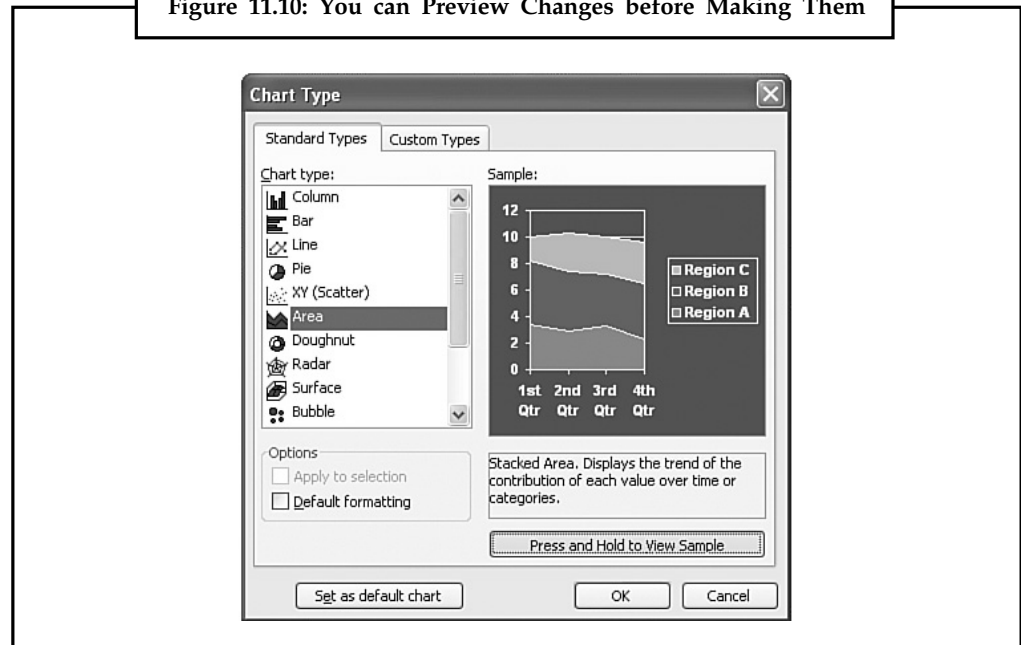

5. If you want to change this to your default, select the Set as Default Chart button.
6. If none of the chart types in the Standard Types tab suits your needs, click the Custom Types tab to view more options. Figure 11.11 illustrates this tab.

Figure 11.11: Custom Charts Provide Variety and Options

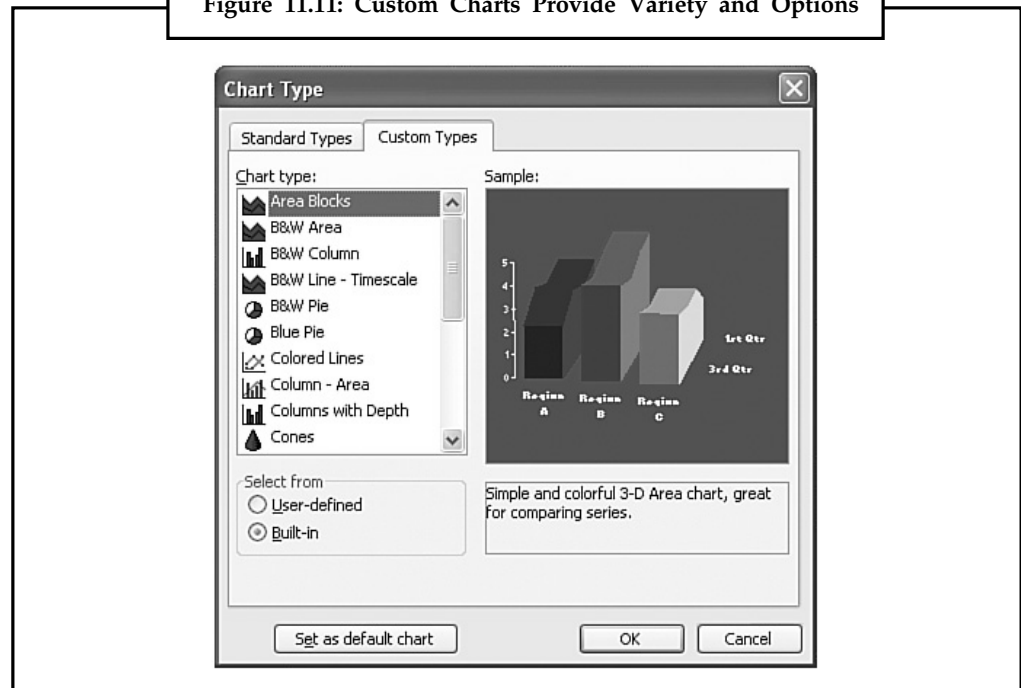

Notes

Custom charts include detailed formatting, and some are customized specifically for a certain kind of output, such as onscreen presentations. The text box beneath the example indicates these details.

7. Click the Built-In option button to display PowerPoint's ready made custom charts.

Notes



Notes

You can also add an active chart in your current presentation to the list of chart types. Simply select the User-Defined option button on the Custom Types tab, click the Add button, and enter details about this active chart to the Add Custom Chart Type dialog box that appears. Microsoft Graph adds this chart to its list of custom chart types.

8. Select the chart type you want to use from the Chart Type list. An example displays in the Sample box.
9. Click OK to apply the chart type and return to your presentation.

11.3.5 Entering Data in the Datasheet

The default datasheet that opens when you first create a chart includes four columns and three rows. This is a common chart format—comparing specific categories over periods of time—but only one of the hundreds of possible formats. Figure 11.12 illustrates this datasheet.

Figure 11.12: Enter Chart Data in a Datasheet, Similar to an Excel Worksheet

		A	B	C	D	E
		1st Otr	2nd Otr	3rd Otr	4th Otr	
1	East	20.4	27.4	90	20.4	
2	West	30.6	38.6	34.6	31.6	
3	North	45.9	46.9	45	43.9	

The first row and column of a datasheet serve as headers for the information in the datasheet. Therefore, the second row begins with the number 1 and the second column with the letter A. In this example, the columns display as the category axis, the rows display as the data series listed in the legend, and the cell data (A1:D3) represents the value axis.



Notes

To reverse the chart and use the column data as the data series instead of the row data, click the By Columns button on the Standard toolbar. Microsoft Graph redesigns the chart based on this change. For example, if you changed the default chart to display in columns, the quarters appear in the legend and the locations appear in the category axis.

To input your own data, just type over the existing information in each cell.

11.3.6 Inserting and Deleting Datasheet Rows and Columns

To delete a row or column, place the cursor within the appropriate row or column and choose Edit, Delete from the menu. To remove the contents of a cell rather than the cell itself, choose Edit, Clear, Contents. Clearing the contents is best when you want to remove existing data and replace it with new data. If you no longer need the row or column, you should delete it. You can delete a row or column by selecting its heading and pressing the Delete key.

Notes



You can also cut (Ctrl+X), copy (Ctrl+C), and paste (Ctrl+V) data in the datasheet by using keyboard commands or by choosing the appropriate buttons on the Standard toolbar.

To insert a new row, select the row below where you want to place the new row and choose Insert, Cells. Microsoft Graph inserts a new row directly above the selected row.

To insert a new column, select the column heading to the right of where you want to place the new column and choose Insert, Cells. Microsoft Graph inserts a new column directly to the left of the selected column.

If you want to insert a new cell, rather than a complete row or column, select the cell where you want to insert a cell; choose Insert, Cells; and choose either Shift Cells Right or Shift Cells Down in the Insert dialog box (see Figure 11.13).

Figure 11.13: Determine the Direction to move the Existing Cells in the Insert Dialog Box

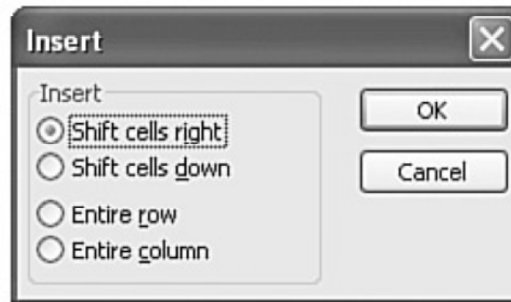

PowerPoint inserts a new cell and shifts the row to the right or shifts the column down, depending on your selection. You can undo insertions and deletions by clicking the Undo button or pressing Ctrl+Z.

11.3.7 Formatting Datasheet Column Width

To format the datasheet's column width, follow these steps:

1. Select the heading of the column whose width you want to adjust.
2. Choose Format, Column Width. The Column Width dialog box appears, as shown in Figure 11.14.

Figure 11.14: You can Customize the Width of a Datasheet Column



3. Type a width for the column the Column Width field. To adjust to the standard width, select the Use Standard Width check box. Or, click the Best Fit button to have the columns adjust automatically based on the existing data.
4. Click OK to return to the datasheet.

11.3.8 Formatting Datasheet Numbers

You can format the text and numbers in your datasheet if you want. To format numerical data, select the cell or cells you want to format and choose Format, Number. The Format Number dialog box appears, as shown in Figure 11.15.

Figure 11.15: Customize the Way Numbers Appear in this Dialog Box

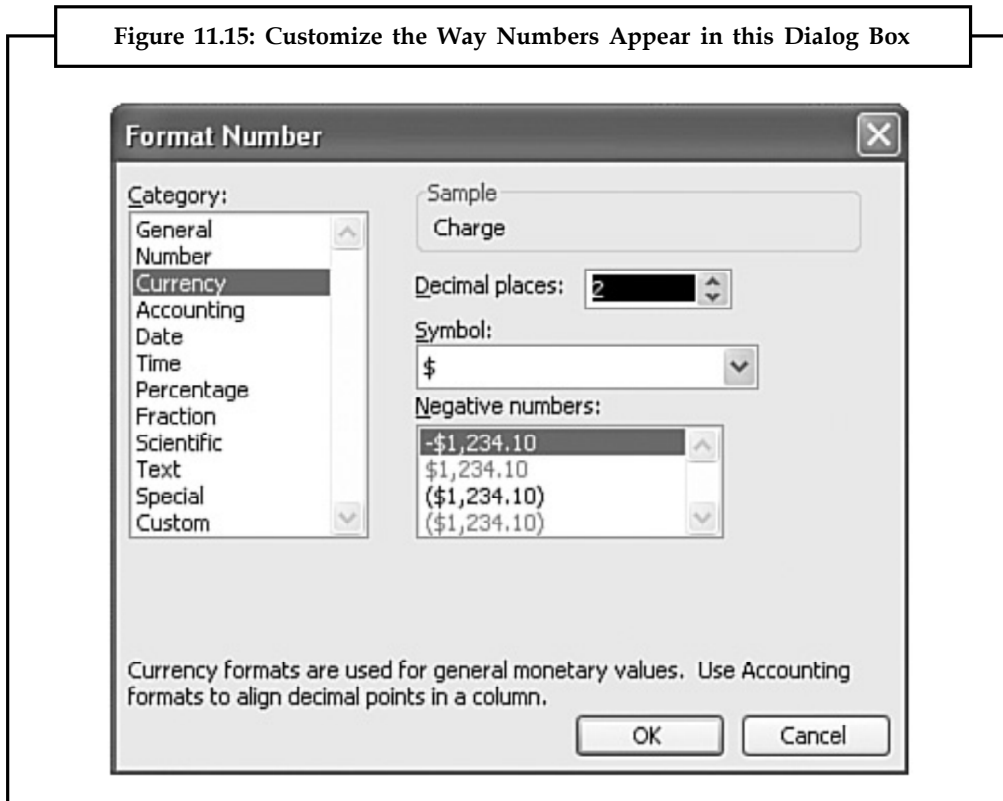

Select the type of number format you want from the Category list, such as date, time, or currency format. Based on your category selection, the right side of the dialog box offers additional formatting options related to the category.

For example, if you choose Currency, the right side of the dialog box lets you choose the currency symbol such as the dollar, pound, or yen. Several of the numeric categories also let you choose the number of decimal places you want to include.

Click OK to accept the formatting changes and to update your chart.

11.3.9 Including and Excluding Rows and Columns

You can include rows and columns in your datasheet, but temporarily hide them in your presentation. To do that, select the column or row that you want to hide, and choose Data, Exclude Row/Col. The row or column appears shaded in your datasheet and temporarily disappears from your presentation. Figure 11.16 shows an example of a hidden column in a datasheet.

Notes

Figure 11.16: This Hidden Column will Temporarily be Removed from the Chart

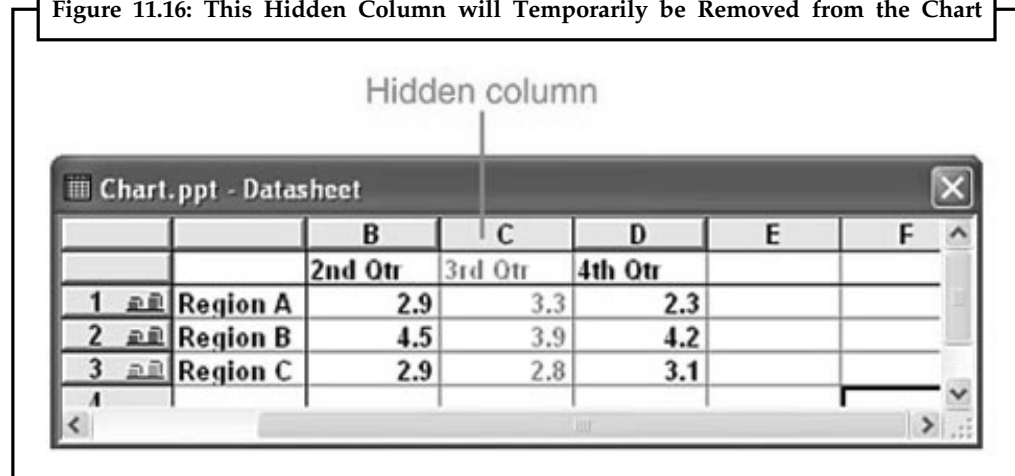

To include this information again, choose Data, Include Row/Col.



Notes

You can also double-click the row or column head to include or exclude the rows or columns. In this case, the action serves as a toggle.

11.3.10 Returning to the Presentation from the Datasheet

When you finish formatting and modifying the datasheet, you can close it by clicking the View Datasheet button on the Standard toolbar. Or you can return to working on the presentation while the datasheet remains open by clicking on any section of the presentation.

To reopen the datasheet, click the View Datasheet button again.

11.4 Design Corner: Using Chart Formatting Options

PowerPoint, in combination with Microsoft Graph, offers numerous chart-formatting options to help you create visually appealing charts. This example shows how even minor changes can enhance your chart.

For example, you could create a basic column chart by choosing the Title and Chart layout from the Slide Layout task pane (see the “Before” figure). To liven up the chart (see the “After” figure), follow these steps using the techniques you learned in this chapter:

1. With your chart active, choose Chart, Chart Options to open the Chart Options dialog box.
2. On the Titles tab, enter a title for your chart.
3. On the Legend tab, place your legend on the bottom.
4. Click the down arrow to the right of the Chart Type button on the Standard toolbar to display a palette of options.
5. Click the Bar Chart button to change to a bar chart format (pause the mouse pointer over the buttons to identify the right button).
6. For each chart object that has text, select it and set the s to match the font used in the slide design.

In only a couple of minutes, you enlivened your chart and made its format better suit your needs.

Before

Notes

Figure 11.17: Chart Formatting Options

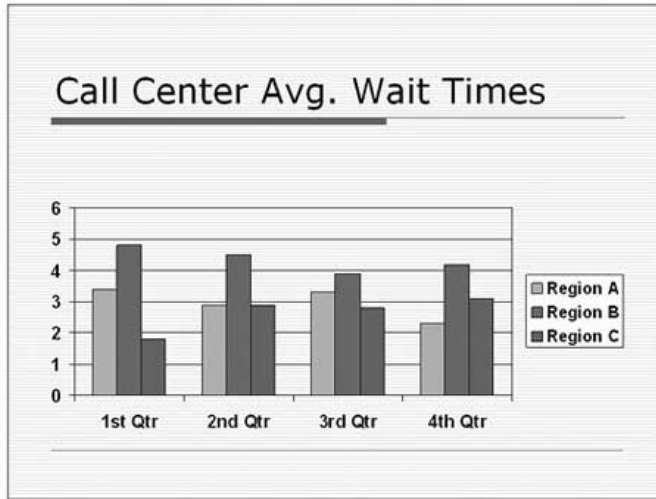

After

Figure 11.18: Cell in horizontal

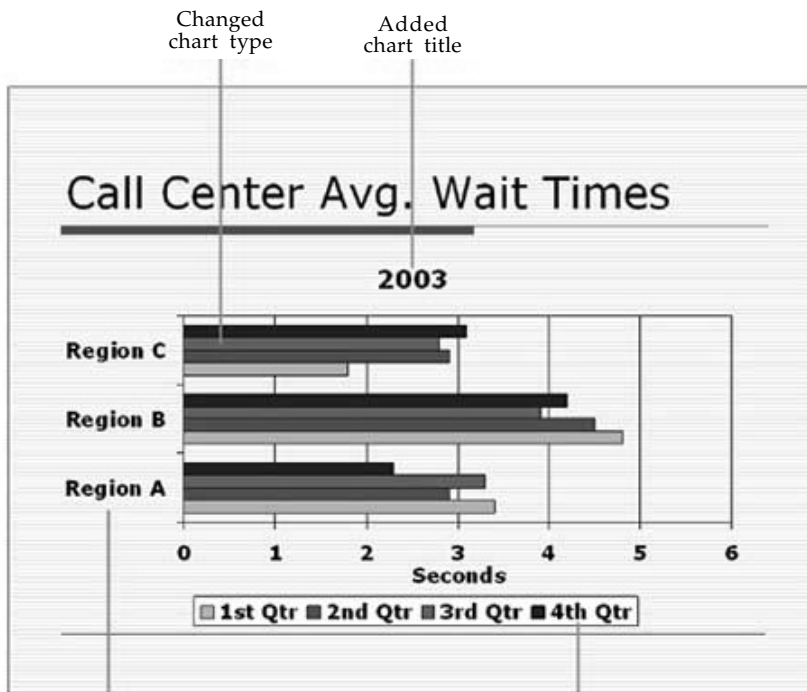

Changed chart type

Added chart title

Made font match slide design

Moved legend to bottom

11.5 Printing

Excel prints only the active area of the worksheet. In other words, it will not print all four million cells - just those that have data in them.

Choose File > > Page Setup, a four tabbed dialog box appears that provides access to most print-related settings.

11.5.1 Change Header and Footer Information on Slides

1. In Normal view or in Slide Sorter view, on the **Outline** tab or **Slides** tab, click the slide that you want to change the header or footer information on.

To select more than one slide, click the first slide that you want to change, and then press and hold CTRL while you click the other slides.

2. On the **Insert** tab, in the **Text** group, click **Header & Footer**.
3. In the **Header and Footer** dialog box, on the **Slide** tab, make the change that you want, and then do one of the following:
 - To apply the changes to the information on the slide or slides that you selected, click **Apply**.
 - To apply the changes to the information on all of the slides in your presentation, click **Apply to All**.

11.5.2 Change Header and Footer Information on your Notes and Handouts

1. In Normal view or in Slide Sorter view, on the **Outline** tab or **Slides** tab, click the slide that you want to change the header or footer information on.

To select more than one slide, click the first slide that you want to change, and then press and hold CTRL while you click the other slides.

2. On the **Insert** tab, in the **Text** group, click **Header & Footer**.
3. In the **Header and Footer** dialog box, on the **Notes and Handouts** tab, make the changes that you want, and then click **Apply to All**.

11.5.3 Delete Header and Footer Information from your Slides

1. In Normal view or in Slide Sorter view, on the **Outline** tab or **Slides** tab, click the slide that you want to delete the header or footer information from.

To select more than one slide, click the first slide that you want to change, and then press and hold CTRL while you click the other slides.

2. On the **Insert** tab, in the **Text** group, click **Header & Footer**.
3. In the **Header and Footer** dialog box, on the **Slide** tab, clear the check boxes for the options that you want to delete from the header or footer.



To remove headers and footers from the title slide, select the **Don't show on title slide** check box.

4. Do one of the following:

Notes

- To remove the information from the slide or slides that you selected, click **Apply**.
- To remove the information from all of the slides in your presentation, click **Apply to All**.

11.5.4 Delete Header and Footer Information from your Notes and Handouts

1. In Normal view or in Slide Sorter view, on the **Outline** tab or **Slides** tab, click the slide that you want to delete the header or footer information from.

To select more than one slide, click the first slide that you want to change, and then press and hold CTRL while you click the other slides.

2. On the **Insert** tab, in the **Text** group, click **Header & Footer**.

3. In the **Header and Footer** dialog box, on the **Notes and Handouts** tab, clear the check boxes for the options that you want to delete from the header or footer.

4. Click **Apply to All**.

Figure 11.19: Printing Window

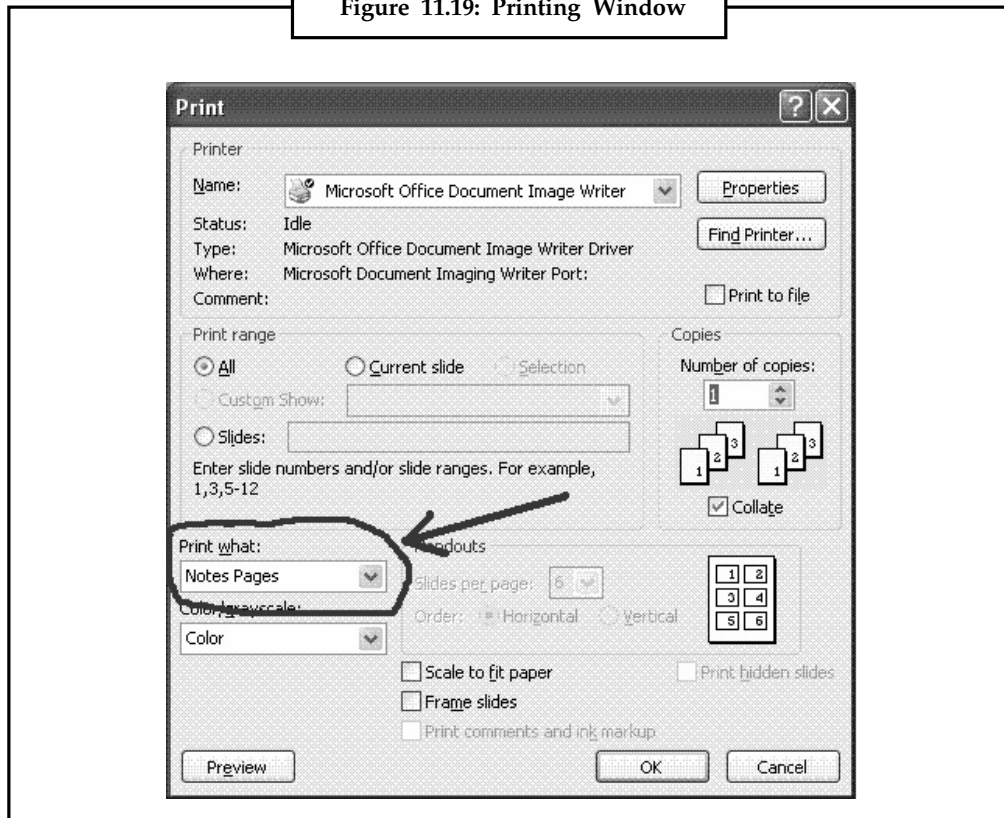

The File >> Print command displays a dialog box that offers the following options:

- **What to Print:** Use the drop-down list to select any of the following options: Document, Document Properties, Comments, Styles, AutoText entries and Key assignments.
- **Copies:** To specify more than one copy of whatever you intend to print, either type a number in the Copies box or click on the up or down arrows next to the box to scroll and choose a number.

Notes

- **Page Range:** To print the entire page range, be sure that the All button is darkened. Click on the little button next to All, if necessary.
- **Print All, Odd, or Even:** Use the drop-down Print list at the bottom of the Print dialog box to specify Odd Pages or Even Pages.

Excel offers a new way to view worksheets: Page break preview mode. To enter in this mode, choose the View > > Page Break Preview command. The worksheet displays changes and user can see exactly what will be printed and where the page breaks occur.



Case Study

Advanced Find and Replace for Microsoft Excel

Advanced Find & Replace for Microsoft Excel is a time-saving add-in that makes search through multiple Microsoft Excel spreadsheets and workbooks easy, fast and comfortable.

With this handy add-in you can search in values, formulas, comments and hyperlinks in all opened workbooks at a time. No need to click “Find Next” time and again. With Advanced Find & Replace you see all found data and their locations at a glance. The add-in reduces the number of clicks to one and the search time to a second. It works fast and flawlessly in Microsoft Excel 2007-2010.

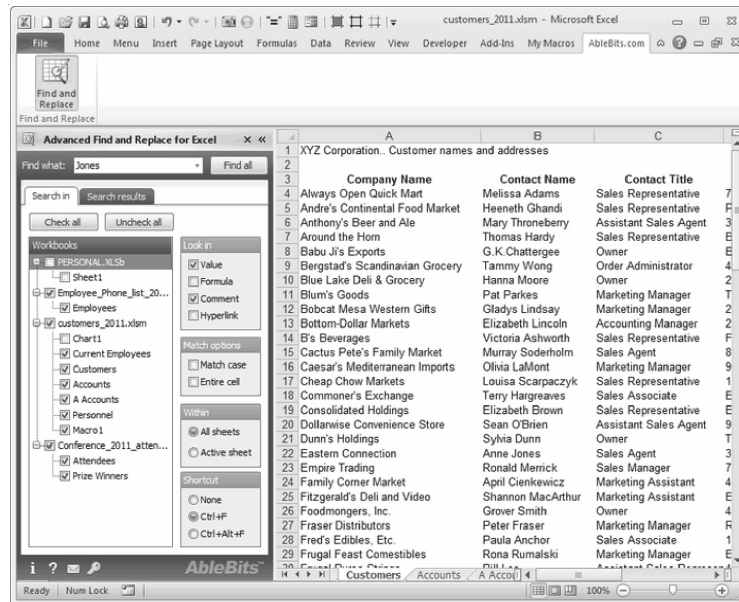

Questions:

1. Explain the advance Replacing.
2. Give the steps to find any word in Excel.

11.6 Summary

- Excel is windows-based spreadsheet created by microsoft corporation, US.
- Excel includes several advanced utilities like the facility to include other objective within a spreadsheet and pivot table and form designing.

- In the Excel the sheets can be worksheets, chart sheets, macro sheets, or custom dialog boxes.
- The Excel read text files, dBASE files, and HEML documents.
- Excel includes an enormous collection of built in function.
- In Excel holds bettors to issue commands when clicked.
- The default data sheet that opens when you first create a char includes four column and three rows, formulating data sheet number and etc.

Notes

11.7 Keywords

Access Internet documents: save document as HTML files and even create advanced analytical tools— Goal seeking, a powerful Solver feature, and the also used to quickly give a name to the selected range or cell.

Analysis application window: minimize, restore, and close.

Built-in functions: Excel includes an enormous collection of built-in functions.

Buttons change: one or more assumptions and observe the effects on dependent formulas.

Control buttons, which can be used to modify the window.

Excel's Built-in Functions: Excel provides a bewildering number of built-in worksheet *Functions* that can be used in formulae. These include common functions such as SUM, AVERAGE, and SQRT as well as functions designed for special purposes such as statistics or engineering Excel's on-line help is excellent and extremely detailed.

File compatibility: Excel can read files produced by other spreadsheet programs.

Formula bar: Information and formulas when entered into Excel, appear in this.

Formulae: Provide the real power while doing analysis and modeling—creating functioning spreadsheet systems.

Great charts: Excel's charting features enable the user to modify and augment a hyperlinks directly in spreadsheet documents. Information between worksheets in different workbooks.

Integrated mapping: This feature lets the user display the data in terms of a Interactive help While working in Excel, the user can get help on-screen.

Internet support: Excel includes a variety of new features that make it easy to. It can also read text files, dBASE files, and HTML documents line.

Linking Workbooks: Linking is the process of using references to cells in external workbooks to get data.

List management: This feature makes it easy to sort, filter, summarize, and manipulate data stored in the worksheet.

Menu bar: One way of issuing Excel commands is through the Menu bar.

Multiple document interface: This capability of Excel makes it easy to transfer.

Multisheet files: Excel's files (called workbooks) can consist of any number.

Name box: Displays the name of the active cell in the current workbook.

Operators in Excel: Excel lets you use a variety of operators in your formulas.

Pivot tables: Using this feature, the user can view the data in summarized table required to create a custom template.

Notes

Scenario management: Excel is often used for what-if analysis, that is, you can separate sheets.

Status bar: It usually contains mode indicator button and keyboard mode

Templates: Excel has a template wizard that walks the user through the steps

The title bar: This identifies the name of the program and also holds some

Toolbars: It holds buttons to issue commands when clicked.

Using the autosum tool: The Sum function is probably the most often used function and the AutoSum tool makes it very easy to enter SUM function onto worksheet. Wide assortment of graph types.

Windows control menu buttons: There are three buttons which control the your worksheet.



Lab Exercise

1. Draw graph charts with the help of power point slide.
2. How to set page layout in power point?

11.8 Self-Assessment Questions

1. Excel uses the Function when creating a data table
 - (a) Average
 - (b) Count
 - (c) Sum
 - (d) Table
2. 3-D reference in a formula
 - (a) Cannot be modified
 - (b) Only appears on summary worksheets
 - (c) Limits the formatting options
 - (d) Spans worksheets
3. The chart wizard
 - (a) Can place a chart on a new chart sheet or on any sheet in the workbook
 - (b) Can only place a chart on new chart sheet
 - (c) Can only place a chart on a new blank worksheet
 - (d) Can only be used to create embedded charts
4. What chart object is horizontal or vertical line that extends across the plot area to make it easier to read and follow the values?
 - (a) Category axis
 - (b) Data marker
 - (c) Data point
 - (d) Gridline
5. What is the keyboard shorZ
 - (a) F3
 - (b) F5
 - (c) F7
 - (d) F11
6. You can use the formula palette to
 - (a) Format cells containing numbers
 - (b) Create and edit formulas containing functions
 - (c) Entered assumptions data
 - (d) Copy a range of cells

7. What Pivot Table toolbar button updates the data in a Pivot Table or Pivot Chart report if the source data character changed Notes
- (a) Format Report (b) Pivot Table
(c) Refresh Data (d) Show Detail
8. Which of the following setup options can not be set in the page setup dialog box?
- (a) Printer selection (b) Vertical or horizontal placement
(c) Orientation (d) Row and column titles
9. Charts tips can
- (a) Show the formatting of a data label
(b) Show the name of a data series
(c) Show the value of data point
(d) Both (b) and (c)
10. You can use the horizontal and vertical scroll bars to
- (a) Split a worksheet into two panes
(b) View different rows and columns
(c) Edit the contents of a cell
(d) View different worksheets

11.9 Review Questions

1. Name the elements which a formula can contain.
2. Can a formula be removed from the worksheet without removing the calculated value?
3. How will you make the cell address in a formula absolute?
4. How is relative addressing different from absolute addressing?
5. Discuss the different kinds of errors that could occur while working in Excel.
6. Briefly explain the AutoSum tool available in Excel.
7. What is a circular reference?
8. What is formatting and why is it used?
9. What do you understand by a cell and a range?
10. What are the different ways to select a range?
11. What is the difference between a contiguous and a non-contiguous selection?
12. Explain the following in brief:

(a) Menu bar	(b) Formula bar
(c) Status bar	(d) Active window
13. How can you cancel a print job which has already been placed in the printer queue?
14. What are Excel Headers and Footers?
15. How to add headers and footers to a worksheet?

Notes

Answers for Self-Assessment Questions

- | | | | | |
|--------|--------|--------|--------|---------|
| 1. (d) | 2. (d) | 3. (b) | 4. (d) | 5. (d) |
| 6. (b) | 7. (c) | 8. (a) | 9. (d) | 10. (b) |

11.10 Further Readings



Books

Fundamental Computer Concepts, William S. Davis.

Fundamental Computer Skills, Feng-Qi Lai, David R. Hofmeister.



Online link

<http://books.google.co.in/bkshp?hl=en>

Unit 12: MS PowerPoint

Notes

CONTENTS

Objectives

Introduction

- 12.1 Getting Started
 - 12.1.1 Presentation Options
 - 12.1.2 Finish
 - 12.1.3 Design Template
 - 12.1.4 Blank Presentation
 - 12.1.5 Auto Layout
- 12.2 Starting PowerPoint
 - 12.2.1 The Screen Elements
 - 12.2.2 PowerPoint Views
 - 12.2.3 Normal View
 - 12.2.4 Outline View
 - 12.2.5 Slide View
 - 12.2.6 Slide Sorter View
- 12.3 Applying Different Color Schemes
 - 12.3.1 Running a Slide Show
 - 12.3.2 Entering Text
 - 12.3.3 Adding Text in Slide View
 - 12.3.4 Adding Text in Outline View
 - 12.3.5 Editing Text
 - 12.3.6 Simple Text Editing
 - 12.3.7 Selecting Text
 - 12.3.8 Cutting, and Pasting Text
 - 12.3.9 Formatting Text
 - 12.3.10 Applying a New Design
 - 12.3.11 Choosing Format with a New Layout
 - 12.3.12 Working with Ruler, Tabs, Indents, and Alignment Options
- 12.4 Enhancing Text
 - 12.4.1 Changing Text Font and Size
- 12.5 Graphics
 - 12.5.1 An Over Graph Type

Notes

12.5.2	Creating a Graph
12.5.3	Choosing Graph Type
12.5.4	Editing Graph
12.5.5	Enhancing Graph
12.5.6	Changeable Chart Elements
12.5.7	Setting Chart Option
12.6	AutoShapes
12.7	Adding Multimedia Content
12.7.1	Insert a Movie using Clip Organizer
12.7.2	Insert a Movie from a File
12.8	Printing Your Presentation
12.8.1	Setting a Default Printer
12.8.2	Printing Slides, Outlines, Notes, or Handouts
12.9	Summary
12.10	Keywords
12.11	Self-Assessment Questions
12.12	Review Questions
12.13	Further Reading

Objectives

After studying this unit, you will be able to:

- Explanation of starting of MS powerpoint
- Understand the starting power point slides
- Process of applying different color schemes
- Explain enhancing text in MS powerpoint
- Understand graphics
- Explain the autosshapes
- Understand the printing presentation
- Explain the process of adding multimedia content

Introduction

MS PowerPoint is a very powerful means of making an effective presentation. It generates presentation slides rich in graphics Audio and Video. The slides generated on power point can be played on a PC or their print-outs cab be projected on an over head projector. When played on a PC it works more like a web-page in an easy-to-move-around way. The slides generated in powerpoint are stored in files of extension <.ppt>. There are, although. Various way to create a powerpoint presentation e.g. generate the slides from MS Word or MS Excel and develop a presentation from PowerPoint itself.

Windows of Microsoft PowerPoint

Notes

When you start PowerPoint, the workspace opens in Normal view. Normal view is divided into 3 areas:

1. **Slide Pane:** Shows the full layout of a slide.
2. **Slides Tab and Outline Tab:** Shows slide thumbnails and text-only hierarchical versions of the slides.
3. **Notes Pane:** Used to input text relevant a specific slide.

Other view include Slide Sorter view which shows thumbnails of the entire presentation and Slide Show view where you preview your presentation.

Figure 12.1: Window of MS PowerPoint 2007

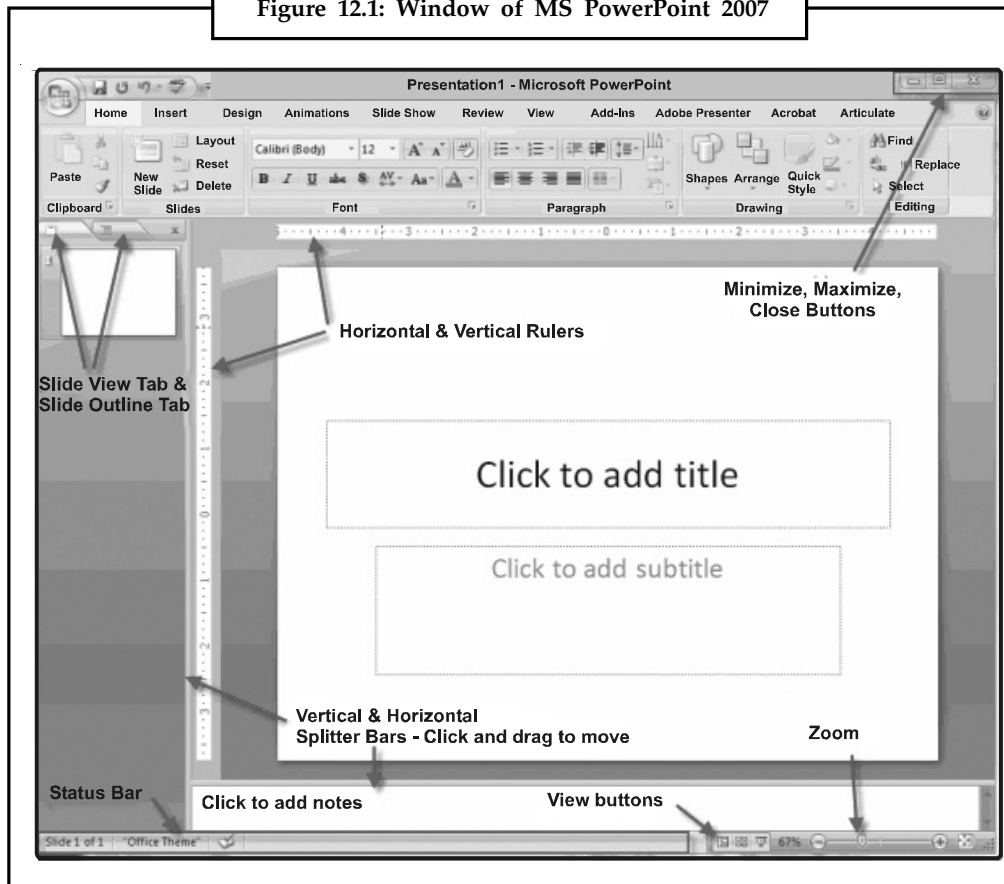

Did u know?

Microsoft PowerPoint, usually just called PowerPoint, is a closed source commercial presentation program developed by Microsoft. It is part of the Microsoft Office suite, and runs on Microsoft Windows and Apple's Mac OS X operating system. The current versions are Microsoft PowerPoint 2010 for Windows and 2011 for Mac.

12.1 Getting Started

If power point is already open or this box does not appear. Select New File from the bar. Otherwise, open Power Point and it will prompt with a dialog box with four choices' Whereas, the "Open an Already Existing Presentation" option enables you update/modify an existing presentation, the other these options are explained in this section.

Notes

Figure 12.2: First Window of PowerPoint



Auto Content Wizard Figure

This method creates a desired presentation in four clicks. Select Auto content wizard and click OK. The AutoContent Wizard provides templates and ideas for a variety of presentation types. Page through the wizard by clicking the Next button on the bottom of each page after making necessary choices.

Presentation Types: It offers choices categorized under General/Corporate/Sales & Marketing/Project. The all types' option displays all templates available. Select appropriate type of template and click next. **Presentation Style** It then asks the options for type of presentation. The options include Web Presentation, On Screen Presentation, OHP (Colored or B&W) or 35 mm film presentation. Select On-screen-Presentation when presenting on a PC from the power point direct, the web style is also the on-screen-presentation with the action more like a web page. When done with the choice of style click next.

12.1.1 Presentation Options

It prompts to select options such as Title of Presentation, number. When done with this click OK.

12.1.2 Finish

Should you need to make any changes in the previous steps click back and then change or else click finish.

Figure 12.3: Auto Content Wizard

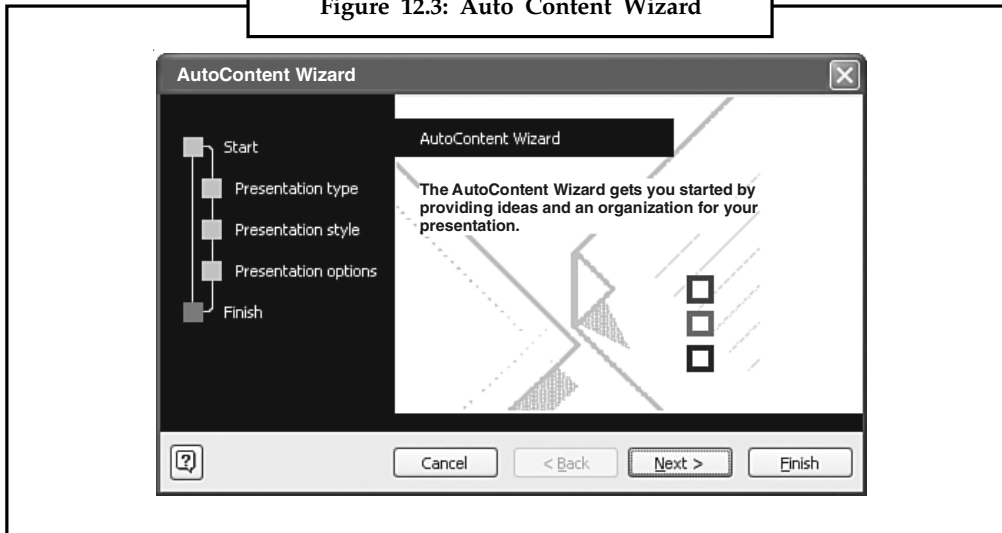

12.1.3 Design Template

Powerpoint provides, many templates with different backgrounds and text formatting to begin the presentation. There are three tabs General, Design Templates and Presentation. Select appropriate type of design and preview each design by highlighting the template name on the list. Press After choosing the design click OK.

Figure 12.4: Design Template

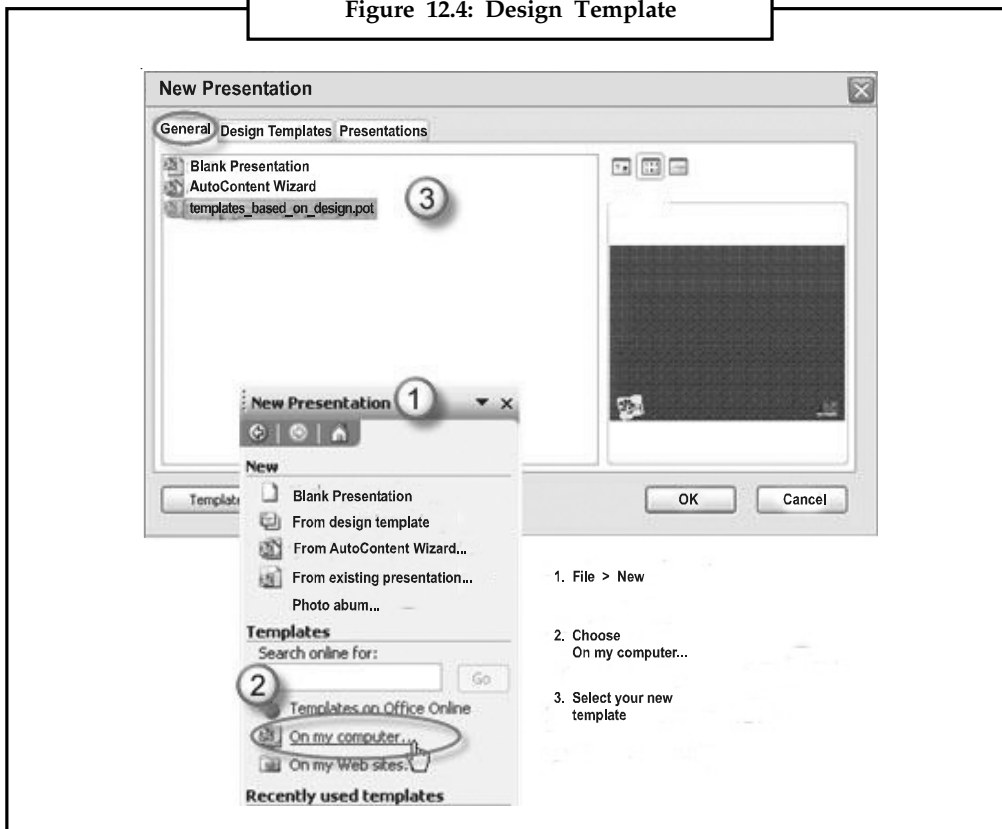

Notes

 Give the steps for adding the Power point wizard.
Task

12.1.4 Blank Presentation

From the General tab select Blank Presentation to build the presentation from scratch with no preset graphics or formatting. Or else select Open. An Existing Presentation to open a power point presentation that already exists. Select the folder the file is located in from look in: drop-down menu and highlight the file on the list. Click Open to open the presentation.

12.1.5 Auto Layout

After selecting the presentation type, it will prompt to choose the layout of the new slide. These layouts include bulleted lists, graphs and/or images. Click on each thumbnail image and a description will be displayed in the message box. Highlight the layout of choice and click OK.

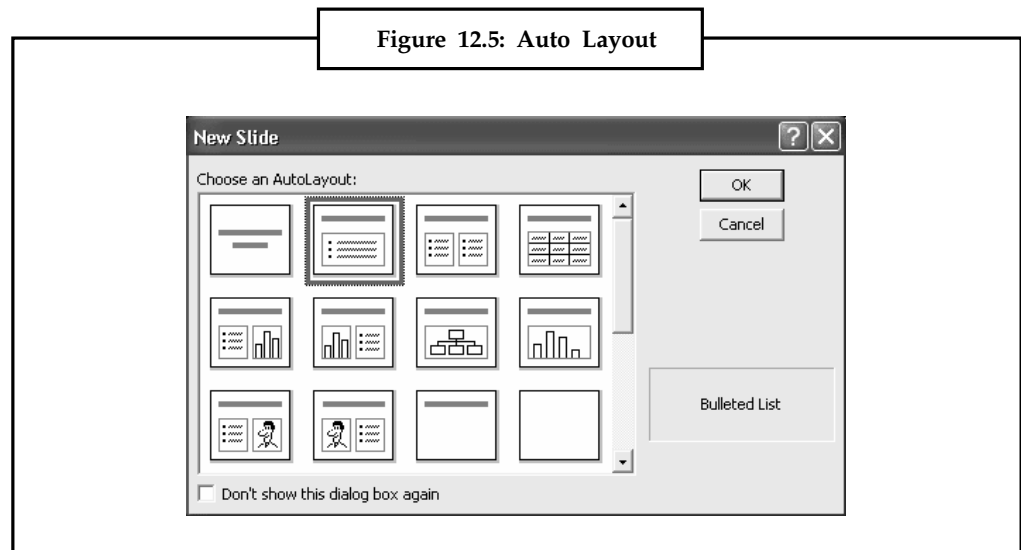

Caution

Powerpoint provides, many templates with different backgrounds and text formatting to begin the presentation. There are three tabs General, Design Templates and Presentation. Select appropriate type of design and preview each design by highlighting the template name on the list. Press After choosing the design click OK.

12.2 Starting PowerPoint

To Start PowerPoint

- Click on Start button located at the bottom left corner of your Windows environment.
- Select Programs option from the Start menu.
- Select Microsoft PowerPoint from Programs submenu.

12.2.1 The Screen Elements

The PowerPoint screen is organized so that everything you need is visible at all times. From the Window-style toolbars and on-screen buttons to the status bar and work area, you won't have any trouble in moving from one view to next quickly.

Figure 12.6: The Screen Elements

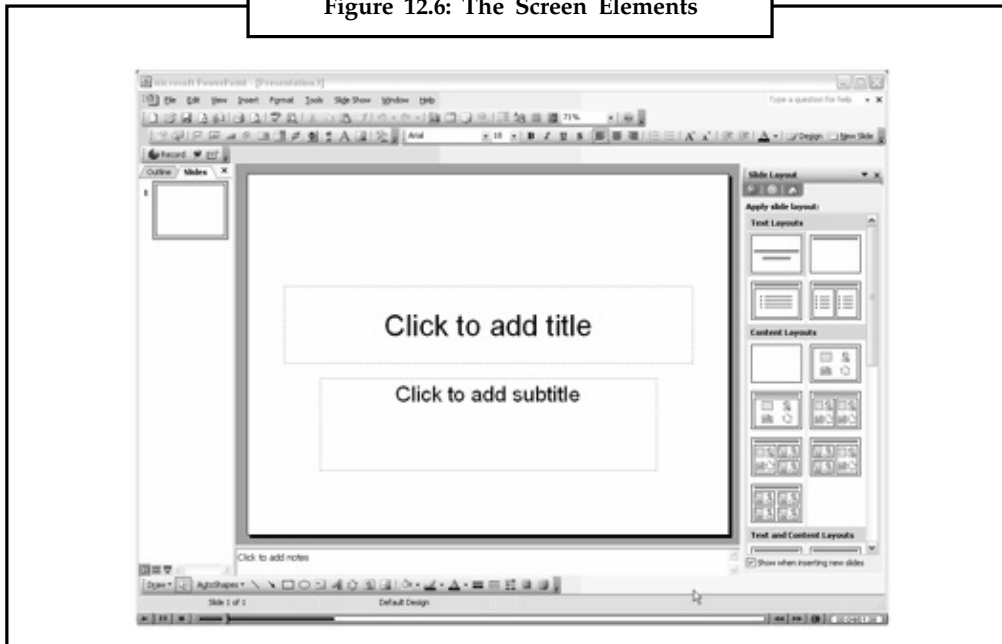

12.2.2 PowerPoint View

PowerPoint provides you several views to look through your presentations. Each of these views is discussed in detail here. The view buttons are available at the lower left corner of the screen.

12.2.3 Normal View

Normal view is the most common view available to you. It is the default view of PowerPoint. It displays slide contents in the left pane while the present slide is displayed in the right pane.

It shows a combination of slide, outline and notes page views. This view is helpful when one has to work in multiple areas at once; add text in outline and see how it appears on the slide; type the notes that will remain with the current slide.

Figure 12.7: Normal View

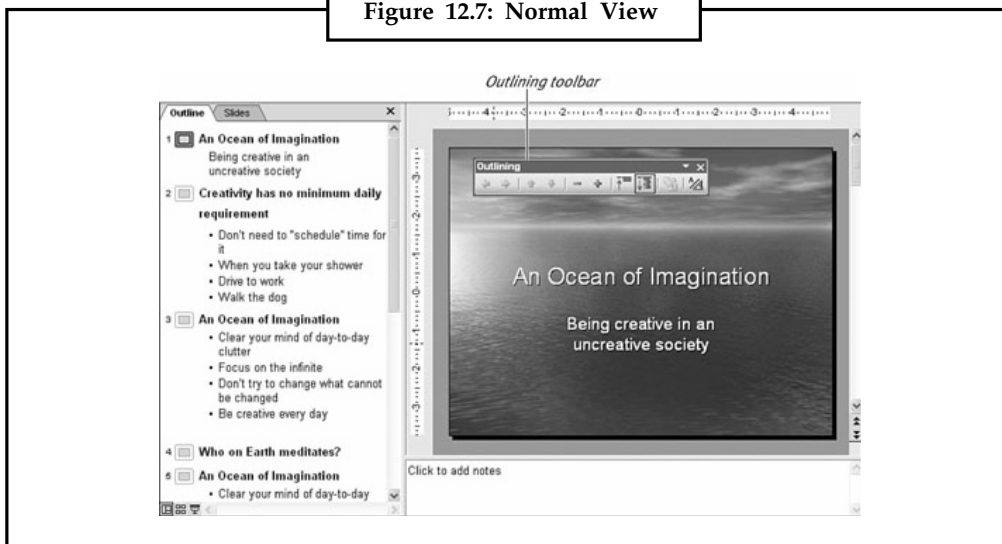

Notes

To select any slide in this view, just click on the particular slide number visible in the left pane.

12.2.4 Outline View

This view displays the presentation text in outline form. It is helpful in entering text quickly, following a format provided by PowerPoint. It is also helpful in moving, copying or cutting text; spell-checking text; reading through for consistency; or printing a script for your presentation.

12.2.5 Slide View

This view gives you the freedom to work on slides only, one by one, while the outlines are minimized on the smaller left pane. It is comparatively easier to add text or objects to a single slide or format only one slide at a time.

The left pane now contains only the slide numbers, so that you can select any one from them.

Figure 12.8: Slide View

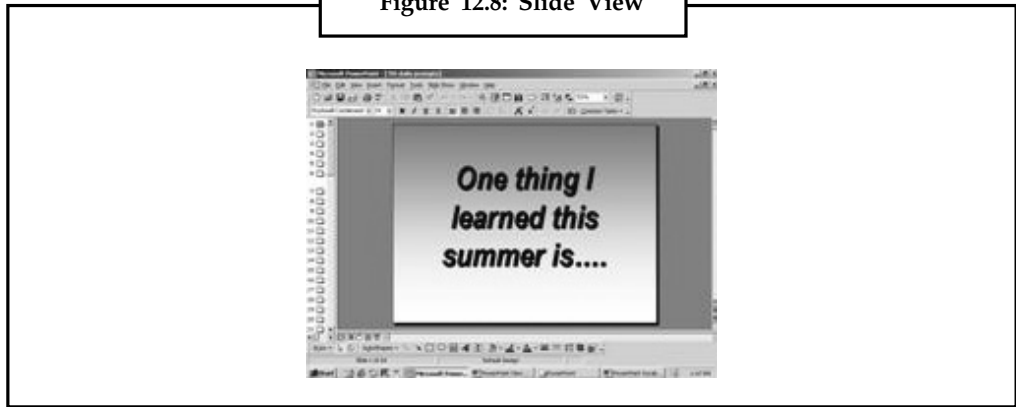

12.2.6 Slide Sorter View

It displays miniature versions of all slides in a presentation, complete with text and graphics. In this view, you can reorder slides, add animation, set timings, move or delete slides, insert new slides or check presentation continuity.

Figure 12.9: Slide Sorter View

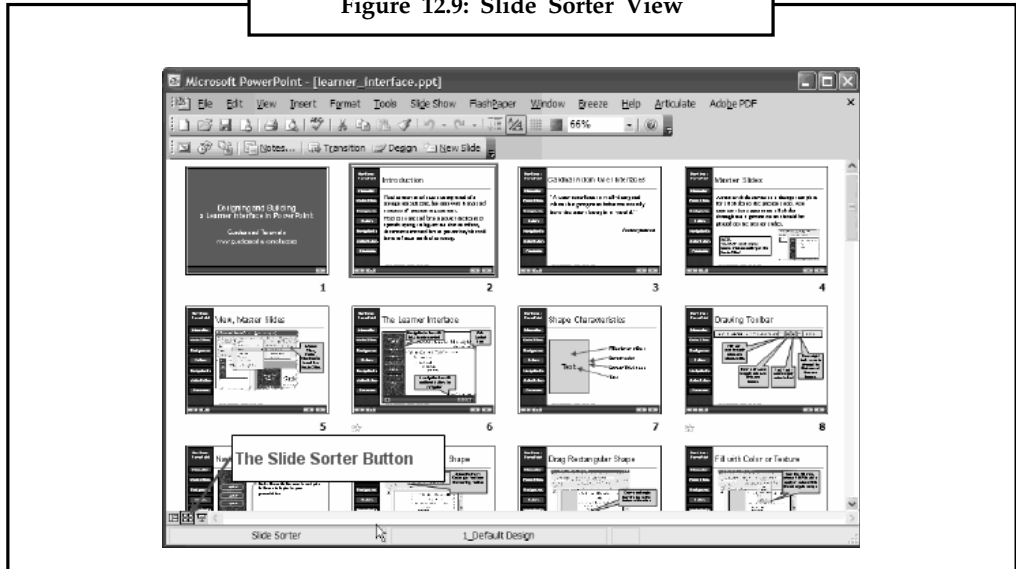



This view displays the current slide in a reduced size with room for notes at the bottom of the page. It is used for adding a memo, notation or instruction for a slide(s). You can also use this view to design explanatory handouts for your audience.

Notes

12.3 Applying Different Color Schemes

Perfect color combination is must for every presentation. You should decide your color scheme before presenting your slide.

PowerPoint helps you to choose a color scheme from any of the available catchy schemes.

Choose Format >> Slide Color Scheme.

Figure 12.10: Applying Different Color Schemes

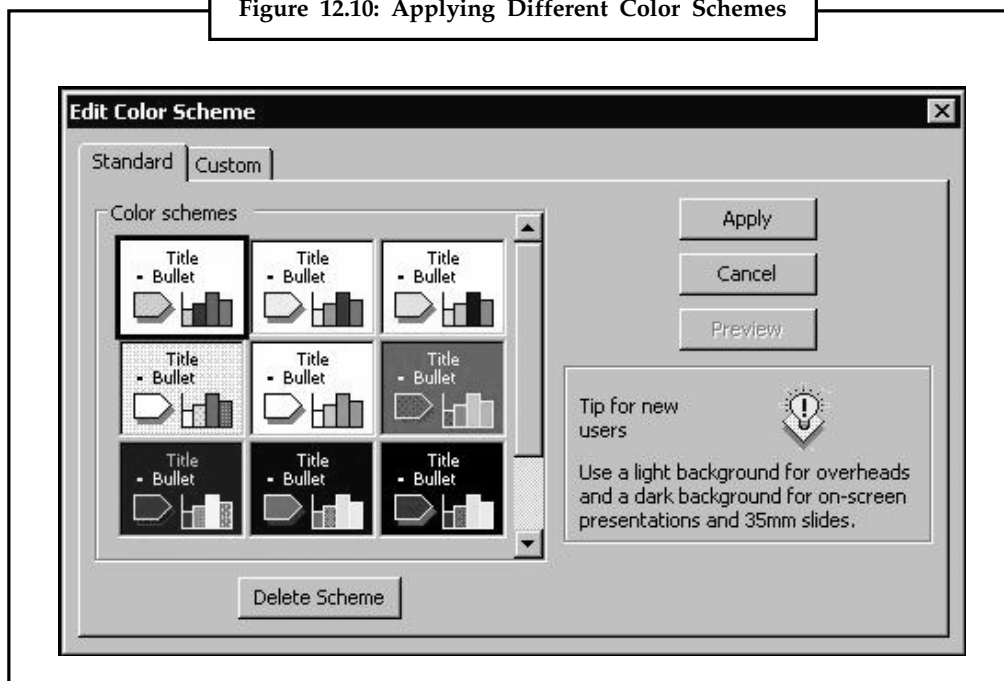

Select any color scheme for General or Custom tab.

12.3.1 Running a Slide Show

After you have finished with your creative work, its time to see the show To start the slide show, click on Slide Show view button, or choose Slide Show >> View Show. The keyboard shortcut is F5.

12.3.2 Entering Text

The text of your presentation carries a lot of weight. Before preparing the text content of your presentation you must follow some rules:

- Too much text should nor be placed on a slide.
- The clearer, the better.
- Know where you are going.

Notes

- Use text to highlight, nor narrate.
- Color and contrast are important.
- Think about your audience.
- Timing.

12.3.3 Adding Text in Slide View

To add the text in Slide view.

Click the text box you want use and Type the text.

If your text takes more than one line PowerPoint automatically wraps the text.

Figure 12.11: Adding Text in Slide View

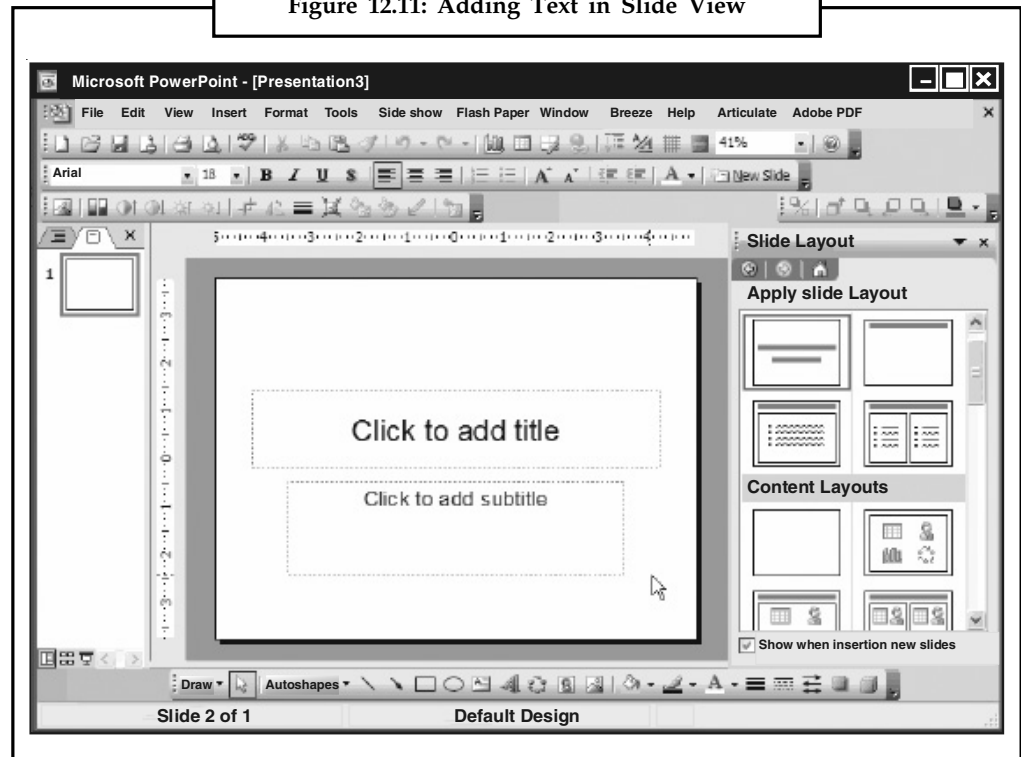

Adding New Text Boxes If you want to add more text than Slide view leaves room for you can add new text boxes to your slide. To add a new text box:

- Click the text box tool.
- Move the cursor to the point on the slide where you want to add the box.
- Hold the mouse button while dragging the mouse down and to the right.
- Release it when the text box is the size you want.

12.3.4 Adding Text in Outline View

To display presentation in Outline view click the Outline View button in the lower-left corner of the screen or choose View >> Outline. The displayed screen will be as follows:

Figure 12.12: Adding Text in Outline View

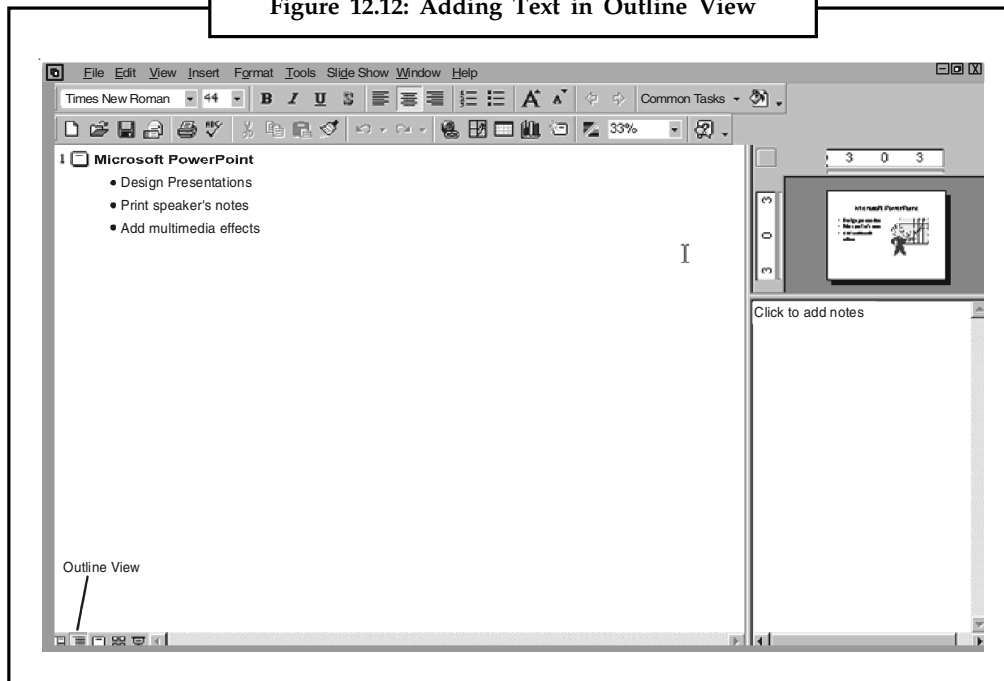

To add text in existing slide use arrow keys to move the cursor to the desired point. To design with new line indented to the same point, press Enter, press Tab to indent the line further. To out dent the line press Shift and Tab and type your text.

12.3.5 Editing Text

Editing text involves the keystroke editing and block-editing.

12.3.6 Simple Text Editing

To make changes in only text box, first click the text box a border appears indicating that you have selected the box. Now position the cursor where you want to make changes. Modify the text. When finished, click outside the box.

12.3.7 Selecting Text

Some editing procedure requires that you mark the text before editing. To do this, click the mouse button when pointer is placed at the beginning of the text you want to mark, press the button and drag the mouse over the section you want to mark.

12.3.8 Cutting, and Pasting Text

Select the text. Click the right mouse button, choose Copy or Cut as desired. Click at destination. Right click the mouse and choose Paste from the shortcut menu that appears.

12.3.9 Formatting Text

The way your text is positioned on a slide contributes to whether or not a viewer actually reads it. Once you have the text into your presentation, you may want to rearrange it to see what's most effective. There are different ways in which you can change the format of your presentations:

- Apply a new design template to the entire presentation.
- Choose a new page layout for the current slide.

Notes

- Use the ruler, tabs, indents, and alignment options to change the way elements are positioned on the slide.

12.3.10 Applying a New Design

Choose Apply Design Template command from the format Menu. The Apply Design Template dialog box appears.

Figure 12.13: Applying a New Design

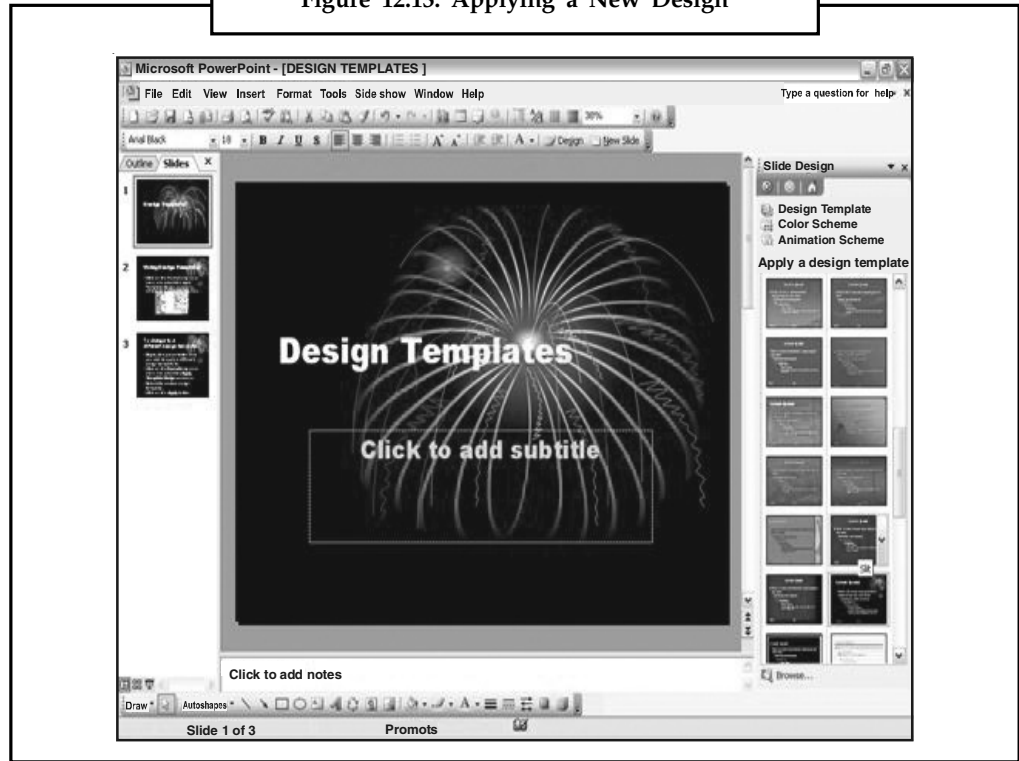

Choose one of the different templates and click Apply.

12.3.11 Choosing Format with a New Layout

The easiest way to change the format is to select a different layout for your presentation. You can change layout but keep the text same by clicking Slide Layout button on the Standard toolbar. From the Slide Layout dialog box, choose the layout you want.

Figure 12.14: Choosing Format with a New Layout

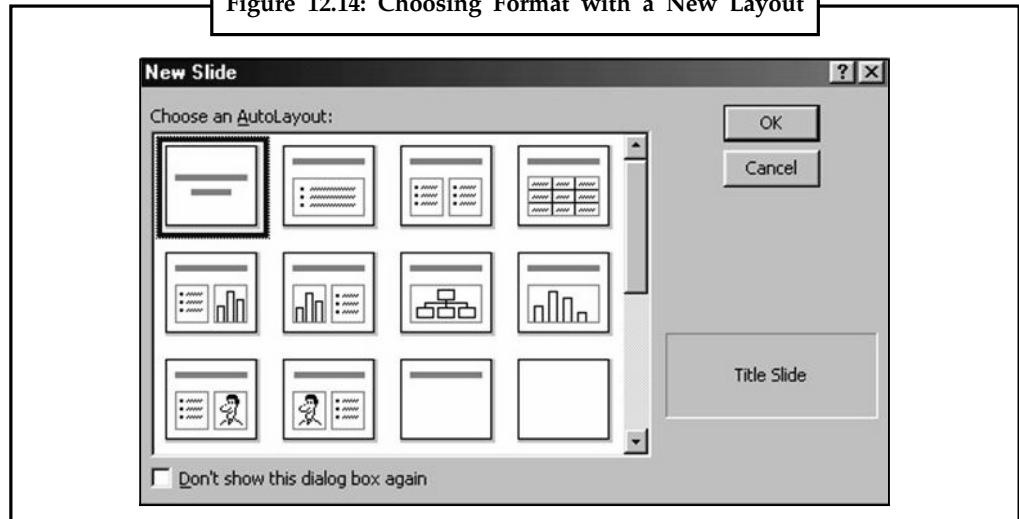

12.3.12 Working with Ruler, Tabs, Indents, and Alignment Options

Notes

If the ruler is not visible, click View >> Ruler. Click on a placeholder or highlight a block of text for which you want to set new tabs. Point to and click on the Tab button at the left edge of the ruler until the desired type of tab appears. Point to a location on the bottom edge of the ruler and click where you wish to insert a tab stop. A tab symbol will appear. To move a tab once it has been inserted, click and drag the tab symbol to a new location on the ruler. To remove a tab, click and drag the tab symbol down and away from the ruler. To align the text select the text and click on Left, Right, Centered or Justified button on the Standard Toolbar.



Did u know?

A film transition is a technique by which scenes or shots are juxtaposed. Most commonly this is through a normal cut to the next scene. Most films will also include selective use of other transitions, usually to convey a tone or mood, suggest the passage of time, or separate parts of the story. These other transitions may include dissolves, L cuts, fades (usually to black), match cuts, and wipes.

12.4 Enhancing Text

12.4.1 Changing Text Font and Size

To change the font, first select the text whose font you want to change. Choose Format >> Font. The Font dialog box appears.

Figure 12.15: Changing Text Font and Size

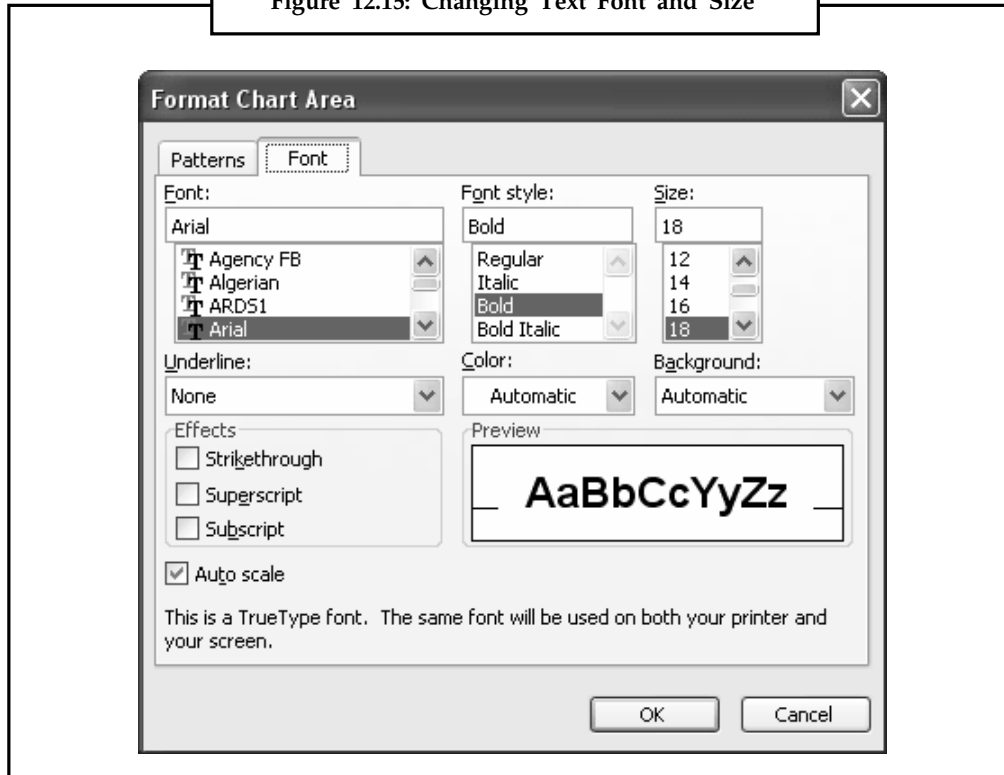

Select a font of your choice and choose other options as desired.

12.5 Graphics

Open the PowerPoint application, and then open the project that you want to edit.

Locate the slide that you want to add the graphic to in the “Slides” window and double-click on the slide. Your slide will open in the middle of the screen.

- Click on the “Click icon to add content” box located on the slide. Find the “Insert Clip Art” icon, which is the top right icon located in the “Click icon to add content” box.
- Find a graphic that will work for your presentation and click “OK.”
- Resize the graphic by clicking on the small circles located around it. Move the graphic by clicking on it and holding down the left mouse button to Save your project.

A graph is the pictorial representation of data. It can help you in many operations such as:

- **Comparisons** Graph can help you illustrate relationships between data.
- **Trends** When you need to show data trends, graphs can help your compare the progress of two data sets.

12.5.1 An Over Graph Type

When you are creating two-dimensional or three-dimensional graphs from scratch with PowerPoint, you’ve got a number of different graph types to choose from, including these:

- Area graphs show one or more data trends over time.
- Bar graphs show how data series “stack up” against each other.
- Column graphs are similar to a bar graph, except that the bars are stacked on top of each other instead of “side-by-side”.
- Doughnut graphs plot more than one data series as part of a whole.
- Line graphs compare data series over time.
- Pie graphs show how individual data items relate to the whole.
- Radar graphs compare data series.

XY (Scatter) graphs plot data points according to X and Y-axes.

Surface graphs show data trends in a two-dimensional view.

Bubble charts compare three sets of data.

2-D and 3-D charts offer cylinder, pyramid and cone shapes.

12.5.2 Creating a Graph

- To create Graph in PowerPoint, firstly you need a slide with graph area. To do this
- Click the New Slide button and choose Chart and Text layout and click OK.
- The new slide appears on the screen with a graph area.

Figure 12.16: Creating a Graph

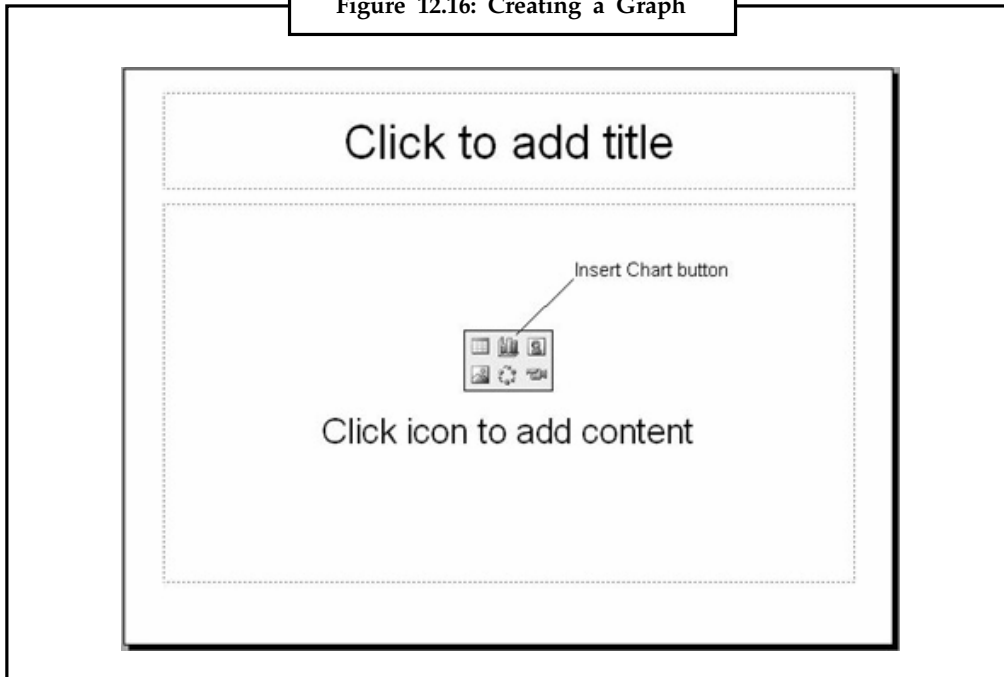

Double-click the graph area.

Sample chart appears on the slide along with a datasheet window containing sample data.

Figure 12.17: Graph of Data

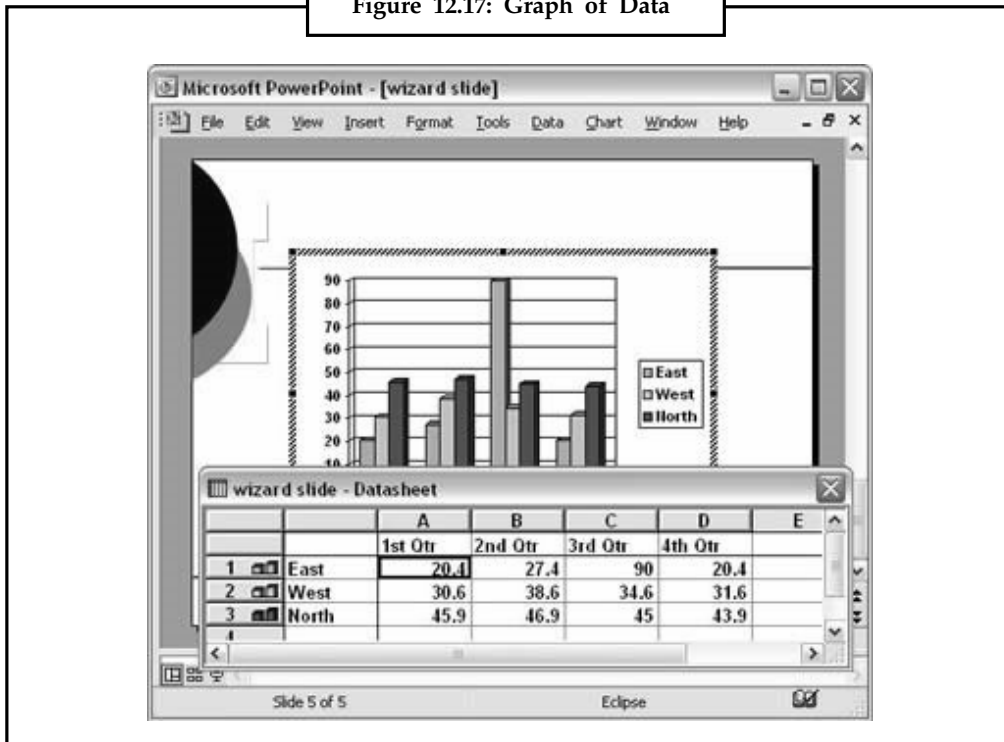

To erase sample data, highlight the information in the datasheet window and press the delete key.

Type your own information into the Datasheet. Note that chart changes to reflect the data.

Notes

 Task Create a graph of Data.

12.5.3 Choosing Graph Type

You can select a chart type in one of the two different ways:

1. Click on Chart type button on Standard toolbar to display the drop down chart box.
2. Select a Chart type and then choose a sub-type.

Figure 12.18: Choosing Graph Type

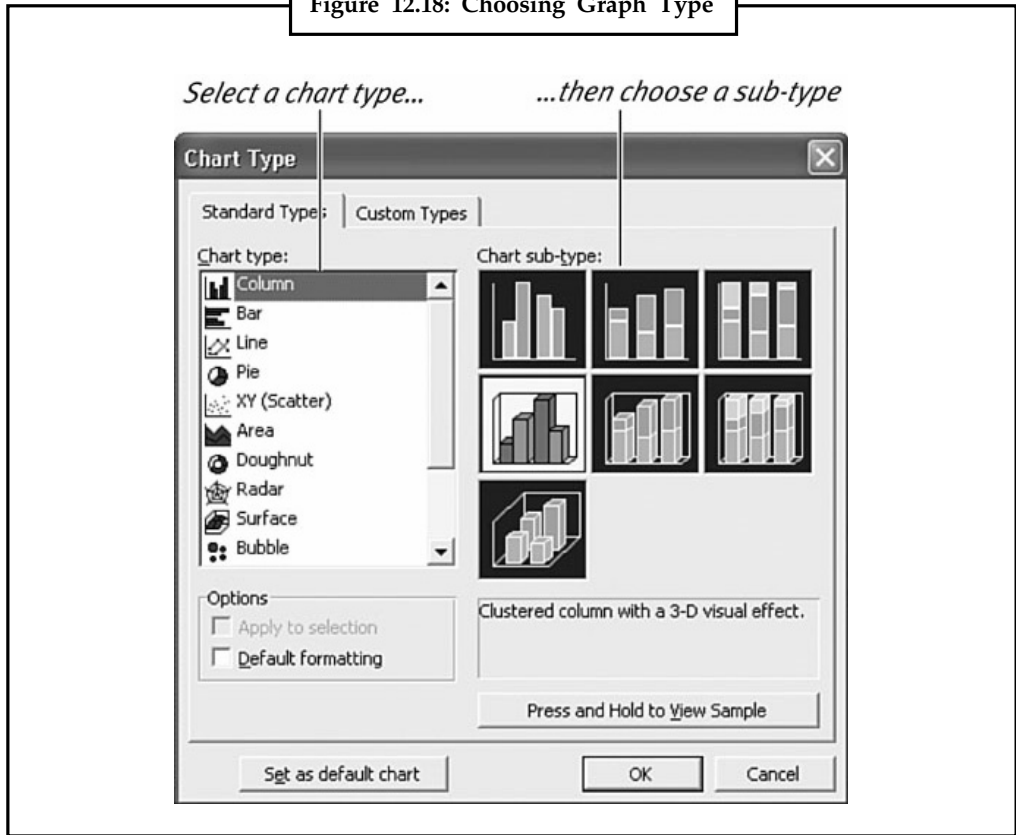

Choose Chart >> Chart Type.

12.5.4 Editing Graph

The Graph frame appears with handles around its outer edge.

To resize a graph Click a handle and drag the graph to resize it horizontally or vertically.

To cut a graph Make sure the graph is selected; then choose Edit >> Cut.

To delete a graph Make sure the graph is selected; then press Del or choose Edit >> Clear.

To copy a graph Select the graph; then choose Edit >> Copy.

To paste a graph Move to the slide on which you want to paste the graph Choose Edit >> Paste.

12.5.5 Enhancing Graph

You can add select, color, background, a text note, add a title or data labels to your chart to enhance its look.

12.5.6 Changeable Chart Elements

You can select and change any of the following chart elements by double clicking on them:

- Individual data series
- The plot area
- The X and Y axes
- The legend
- The gridlines

12.5.7 Setting Chart Option

You can set various chart options to enhance its look. To do this Select the chart.

Choose Chart >> Chart Options.

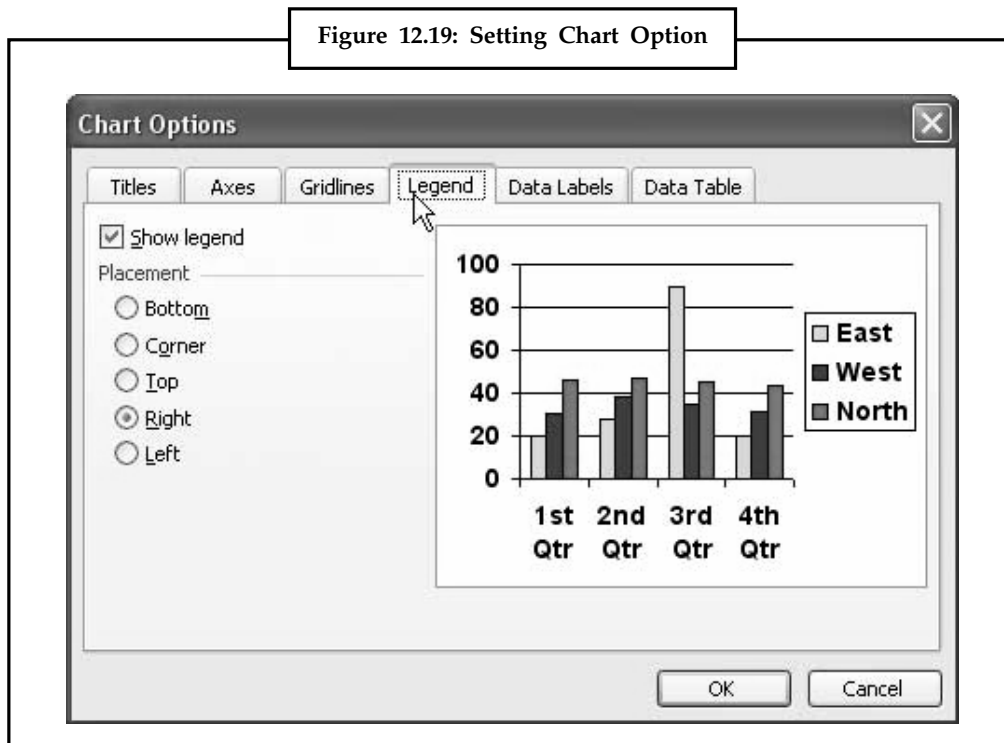

From the dialog box, click on different tabs and select options as desired.

12.6 AutoShapes

To emphasize important points in your presentation, you might want to include PowerPoint auto shapes in addition to text. The Shapes you draw in PowerPoint are objects that can be sized, moved, copied, and formatted in a variety of ways to suit your needs.

Notes

PowerPoint provides several tools for creating several types of shapes including arrows, banners, stars, rounded rectangles, circles, squares, and more. Shapes can be worked with individually or they can be grouped and treated as one shape.

To create almost any shape in PowerPoint, you click on a tool from the Drawing toolbar or from the PowerPoint AutoShapes menu and then drag in the location where you want the shape to appear.

Figure 12.20: AutoShapes

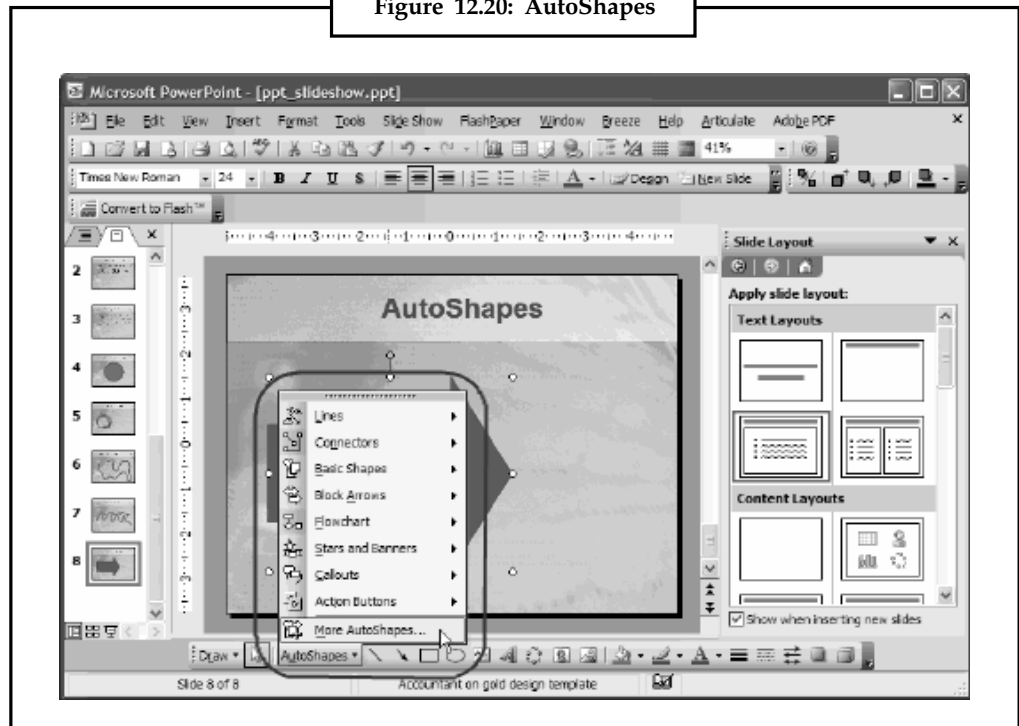

12.7 Adding Multimedia Content

You can insert one or more video clips—that is, movies—into any slide. You might want to play a video quote from your product manager.

Most of the movie clips stored in the Clip Organizer are simply animated .gif files, small files that contain an animated sequence of images. If you imported your own movie files into the Clip Organizer, you will find them there, too, generally stored in .avid format. You might be able to find additional movie clips on your network, intranet, or the Internet.



Notes

Before you insert video clips, think about the environment you'll be presenting in. Does the computer you will use have the necessary hardware (such as a sound card, speakers, and an enhanced video card) for playing the multimedia items during your presentation? You might consider adding only a few multimedia elements just in case. If the machine you give your presentation on doesn't support them, plan an alternate way to make your presentation compelling. With this basic detail considered, you'll find that adding video and sound is the same as adding any other item to your slides, and the special effects are truly exciting.

To insert a movie into a slide, follow these steps:

Notes

12.7.1 Insert a Movie Using Clip Organizer

1. Display the slide in which you want to add a video clip.
2. On the **Insert** menu, point to **Movies and Sounds**, and then click **Movie from Clip Organizer**.

You can now browse the Clip Organizer for a movie clip. PowerPoint will open the **Clip Art** task pane and will select the **Movies** option in the **Results should be** drop-down list.

3. Click the movie you want to add to your slide.



Notes

Some of the layouts you can apply to a slide (using the **Slide Layout** task pane) add a group of buttons to the slide for inserting various types of objects. These are known as **Content Layouts** or **Text and Content Layouts**. If you have applied such a layout to your slide, you can insert a video clip from the Clip Organizer by clicking the **Insert Media Clip** button and selecting a video clip in the **Media Clip** dialog box (which displays both movie and sound clips). However, the **Clip Art** task pane (or the freestanding Clip Organizer program) provides more features for locating and inserting a video clip and usually makes the task easier.

12.7.2 Insert a Movie from a File

You can insert a movie from a movie file on a local disk, a shared network location, or an Internet site.

1. On the **Insert** menu, point to **Movies and Sounds**, and then click **Movie from File**.
2. Select the movie file in the **Insert Movie** dialog box, and then click the **OK** button.

If you selected a movie clip in animated .gif format, the animation will run automatically the entire time the slide is displayed in a slide show. If, however, you selected a movie in another format (such as .avid), PowerPoint will display a message box letting you choose when the movie will play.

- To have the movie play automatically when the slide is displayed in a slide show, click the **Automatically** button.
- To have the movie play only after you click the movie image, click the **When Clicked** button. PowerPoint will then add the clip (?) to your slide.

12.8 Printing Your Presentation

When printing with PowerPoint, you can choose the format of your printed page. PowerPoint offers eight formats:

- Slides
- Notes Pages
- Outline View
- Handouts-1 slide per page
- Handouts-2 slides per page

Notes

- Handouts-3 slides per page
- Handouts-4 slides per page
- Handouts-6 slides per page
- Handouts-9 slides per page

12.8.1 Setting a Default Printer

Before you begin printing, it is often best to set a default printer so that your presentation will automatically be sent to the printer you want.

1. From the *Start* menu, select *Printers and Faxes* The *Printers and Faxes* dialog box appears.
2. Select the printer you wish to set as your default printer.
3. From the *File* menu, select *Set As Default Printer* The selected printer is now the default printer.
4. From the *File* menu, select *Close*.

12.8.2 Printing Slides, Outlines, Notes or Handouts

1. Open your presentation.
2. In the *Slide Sorter* view, from the *File* menu, select *Print*.
3. The *Print* dialog box appears.
4. To print more than one copy, in the *Number of copies* text box, type the number of copies.
5. From the *Print what* pull-down list, select the presentation format you want to print.

Figure 12.21: Printing Option of Slide

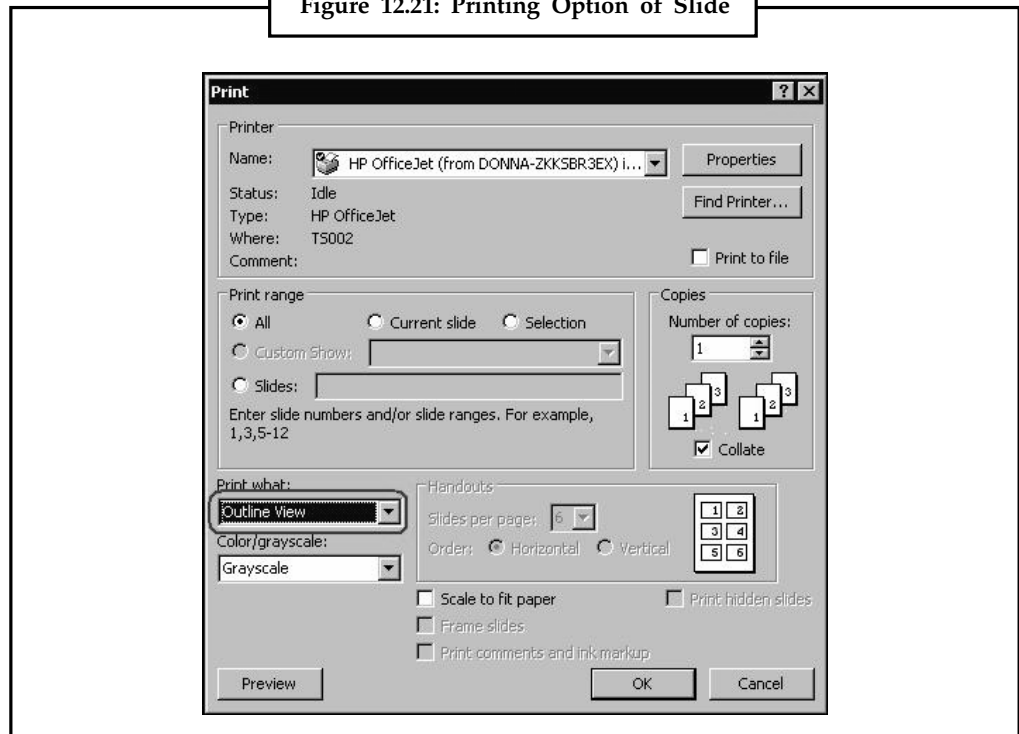

6. To print a specific slide(s), in the *Slides* text box, type the slide number(s).
7. Click OK.

Notes



Notes

If you are printing handouts, three slides per page is often the best choice; slides are printed large enough to be easily read, and there is space on one side of the page for your audience to take notes.



Did u know?

To print a range of slides, type the beginning number, a hyphen, and the ending number (e.g., to print pages seven through twelve, type 7-12).

To print non-consecutive slides, type their numbers separated by commas (e.g., to print pages seven and twelve, type 7, 12).



Case Study

Since the late 1960's visual artists in museums and galleries have used slide shows as a device, either for presenting specific information about an action or research or as a phenomenological form in itself. According to the introduction of [Slide show] — an exhibition organized at the Baltimore Museum of Art- "Through the simple technology of the slide projector and 35 mm color transparency, artists discovered a tool that enabled the transformation of space through the magnification of projected pictures, texts, and images". Although some have not necessarily used 35 mm or color slides, and some have even exchanged images for texts (Robert Barry) the color slides are the most commonly used and they could be sometimes accompanied with written text, either on the slides or as an infertile. Some artists have also used a voice-over on the slide presentation (James Coleman, Robert Smithson). Slideshows have since also used by artist that use other mediums as painting and sculpture to present their work publicly. During the last few years there is a growing usage of the concept by a younger generation of artists. Non-profit organization Slide luck Potshot holds slideshow events globally featuring works by amateur and professional artists, photographers, and galleries. Participants in the event bring food, potluck-style, to have a social dinner before the slide show begins.

Questions:

1. What is the purpose of developing MS PowerPoint?
2. How MS PowerPoint invented?

12.9 Summary

- Powerpoint is a powerful presentation package of microsoft.
- The normal view is the default view of power point which shows a combination of slides, outline and notes page view.

Notes

- Outline view displays the presentation in outline form making it easy to copy, move or delete slides.
- The slide view offers one slide at time for editing.
- The slide sorter view displays main true version of all slides in presentation.
- The Auto content wizard provides an outline for your presentation.
- Powerpoint's build in templates can used as the basis for the presentation.

12.10 Keywords

Auto layout: After selecting the presentation type, it will prompt to choose the layout of the new slide. These layouts include bulleted lists, graphs and/or images.

Blank presentation: From the General tab select Blank Presentation to build the presentation from scratch with no preset graphics or formatting. Or else select Open.



Lab Exercise

1. Explain different ways to view slides in PowerPoint.
2. Show slide layouts in PowerPoint.

12.11 Self-Assessment Questions

1. Which file format can be added to a PowerPoint show?
(a) jpg (b) gif
(c) wav (d) All of these
2. In Microsoft PowerPoint two kind of sound effects files that can be added to the presentation are:
(a) wav files and .mid files (b) wav files and .gif files
(c) wav files and .jpg files (d) .jpg files and .gif files
3. Material consisting of text and numbers is best presented as:
(a) a table slide (b) a bullet slide
(c) a title slide (d) All of these
4. What is a motion path?
(a) A type of animation entrance effect
(b) A method of advancing slides
(c) A method of moving items on a slide
(d) All of the above
5. What is a slide-title master pair?
(a) The title area and text area of a specific slide
(b) A slide master and title master merged into a single slide

- (c) A slide master and title master for a specific design template
 - (d) All of these
6. Which of the following should you use if you want all the slide in the presentation to have the same “look”?
- (a) The slide layout option
 - (b) Add a slide option
 - (c) Outline view
 - (d) Presentation design template
7. In the context of animations, what is a trigger?
- (a) An action button that advances to the next slide
 - (b) An item on the slide that performs an action when clicked
 - (c) The name of a motion path
 - (d) All of these
8. If you have a PowerPoint show you created and want to send using email to another teacher you can add the show to your email message as a (an)
- (a) inclusion
 - (b) attachment
 - (c) reply
 - (d) forward
9. In order to edit a chart, you can
- (a) triple click the chart object
 - (b) click and drag the chart object
 - (c) double click the chart object
 - (d) click the chart object
10. To exit the PowerPoint
- (a) click the application minimize button
 - (b) click the document close button
 - (c) double click the applications control menu icon
 - (d) double click the document control menu icon

12.12 Review Questions

1. What is MS PowerPoint?
2. How do you play sounds across multiple slides?
3. Explain different ways to view slides in PowerPoint.
4. Explain slide layouts in PowerPoint.
5. Make Font Colors and Styles Stand Out on PowerPoint Slides.
6. Differentiate between a template and wizard.
7. How can you apply a different color scheme to your presentation?
8. What is an AutoContent wizard?
9. What is the difference between Notes Page and Slide Sorter view?
10. How can you run a presentation?

Notes

Answers for Self-Assessment Questions

- | | | | | |
|--------|--------|--------|--------|---------|
| 1. (d) | 2. (a) | 3. (a) | 4. (c) | 5. (c) |
| 6. (d) | 7. (b) | 8. (b) | 9. (c) | 10. (c) |

12.13 Further Reading



Books

A Study of Computer Fundamental, Shu-Jung Yi.



Online link

<http://books.google.co.in/bkshp?hl=en>

Unit 13: Internet

Notes

CONTENTS

Objectives

Introduction

- 13.1 Internet-Brief History
- 13.2 Web Page
 - 13.2.1 Color, Typography, Illustration, and Interaction
 - 13.2.2 Dynamic Behavior
- 13.3 Website
 - 13.3.1 Book Marking
 - 13.3.2 Printing
 - 13.3.3 To Download
 - 13.3.4 To Personalise the Display
- 13.4 Browsers
 - 13.4.1 Elements
 - 13.4.2 Rendering
 - 13.4.3 Web Browser Environment
- 13.5 URL
 - 13.5.1 Viewing
 - 13.5.2 Creation
 - 13.5.3 Saving
 - 13.5.4 Getting Started of Web Page
- 13.6 HTML
 - 13.6.1 Data Types
 - 13.6.2 Document Type Declaration
- 13.7 Internet Service Provider (ISP)
 - 13.7.1 Access ISPs
 - 13.7.2 Locality
 - 13.7.3 Hosting ISPs
 - 13.7.4 Transit ISPs
 - 13.7.5 Peering
 - 13.7.6 Derivatives
- 13.8 Summary
- 13.9 Keywords
- 13.10 Review Questions
- 13.11 Self-Assessment Questions
- 13.12 Further Reading

Notes

Objectives

After studying this unit, you will be able to:

- Explain the brief history of internet and Web page
- Discuss about the Web page its features
- Explain browsers and URL
- Discuss various HTML data types and ISP's
- Explain various components of Wabsir and its features

Introduction

In the present scenario of Information Technology, Internet has become a popular mode of communication. It has permeated all spheres of life. Internet shares information with anybody. Anywhere in the world with a minimum amount of financial resources. Internet is the combination of millions of computers. Connected together either through phone lines. Ethernet ISDN or cable modems, etc. so that they can share information. The internet is really a big network.

One of the scientists referred, Internet as an 'ocean', because of its enormity and power. Some people are said to 'surf', 'ride' or 'navigate' the 'net'. It is probably more accurate to say most people begin to 'swim' through the Internet, until they find their own way. With the Internet, the possibilities are endless. Some of them are mentioned below.

School children, for example in Delhi can 'talk' to their friends in Mumbai.

Teachers and administrators can have a conference with other colleagues thousands of kilometers away. A professional on a business trip can access the computer in her or his home or office, and then dispatch hundreds of messages with a few simple clicks. The students can get information of any subject at anytime through Internet. The jobseekers can get information on different kind of jobs all over the world. The students wish to take admission for higher education can get information from different institutions in any part of the global. And these are just the beginning with the Internet. The limits are only determined by how much you want to take from it.

13.1 Internet-Brief History

The Internet was first started as an experiment by the United States Department of defense in 1969. The United States military needed a way for its researchers to communicate and share programs with one another over their computers. The defense computer researchers developed the first long distance network of computers, which was called ARPANET (Advanced Research Projects Agency—Network). Remote military sites were then 'connected' to one another, via telephone lines. Universities and scientists saw the advantage of long distance networking. They began to connect with ARPANET as well as to each other. Businesses and private individuals then started connecting through the network of computers. Eventually the massive network of networks developed, known as **Internet**.

Today, no individual, no corporation and no government owns the Internet—it is owned, operated and maintained by all of those who use it. The Internet was first started as an experiment by the United States Department of Defence in 1969. The United States military needed a way for its researchers to communicate and share programs with one another over their computers. The defense computer researchers developed the first long distance network of computers, which was called ARPANET (Advanced Research Projects Agency—Network). Remote military sites were then 'connected' to one another, via telephone lines. Universities

and scientists saw the advantage of long distance networking. They began to connect with ARPANET as well as to each other. Businesses and private individuals then started connecting through the network of computers. Eventually the massive network of networks developed, known as **Internet**. Today, *no* individual, no corporation and no government owns the Internet—it is owned, operated and maintained by all of those who use it.

Notes

- (i) Go to a Computer Laboratory with internet connection facility.
- (ii) Connect internet by understanding how a telephone number; a user's name and a password is fed into the computer for internet connection.
 - (a) Click the icon, **shortcut to Dial-up** created at the desktop of the computer shown in Figure 13.1.

Figure 13.1: A Desktop with Shortcut to Dial-up...Icon

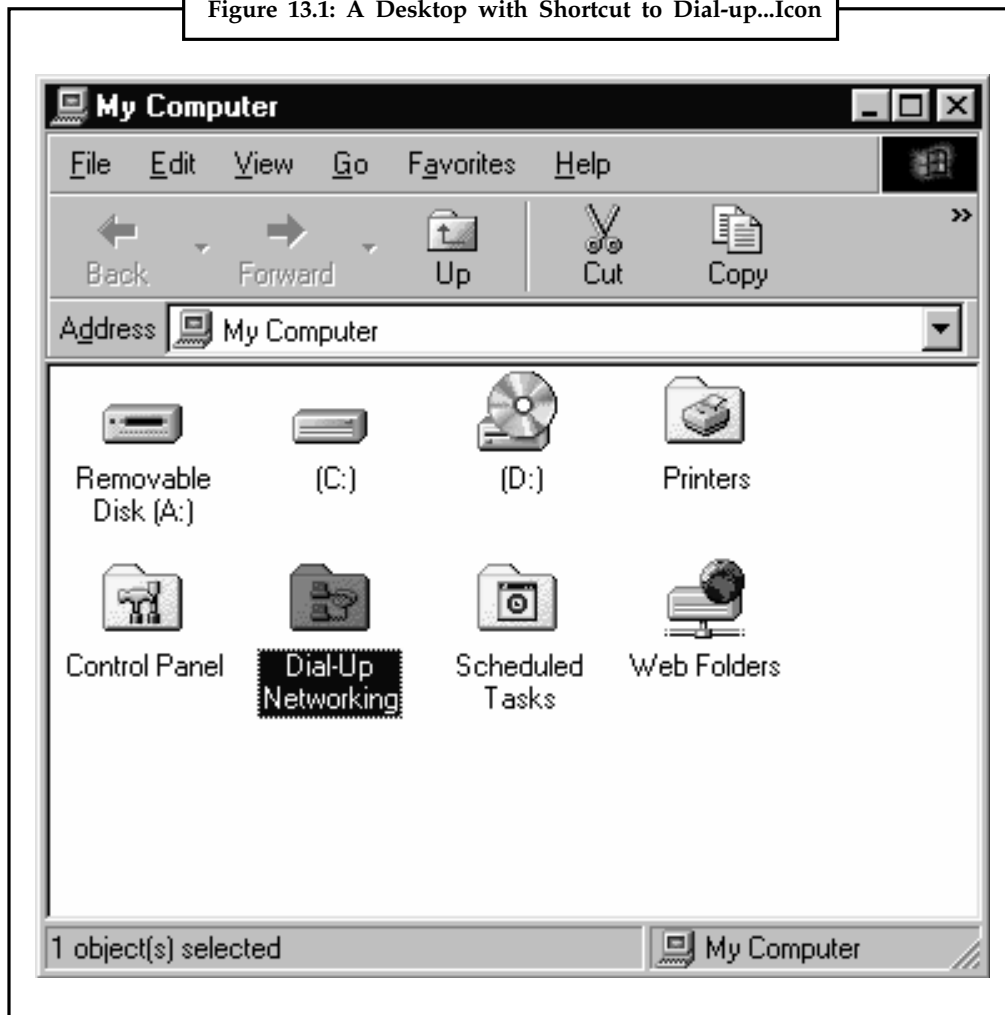

In United States military needed a way for its researchers to communicate and share programs with one another over their computers.

13.2 Web Page

A **Web page** or **Webpage** is a document or information resource that is suitable for the World Wide Web and can be accessed through a web browser and displayed on a monitor or mobile device. This information is usually in HTML or XHTML format, and may provide navigation to other web pages via hypertext links. Web pages frequently subsume other resources such as style sheets, scripts and images into their final presentation.

Web pages may be retrieved from a local computer or from a remote web server. The web server may restrict access only to a private network, e.g. a corporate intranet, or it may publish pages on the World Wide Web. Web pages are requested and served from web servers using Hypertext Transfer Protocol (HTTP).

Web pages may consist of files of static text and other content stored within the web server's file system (static web pages), or may be constructed by server-side software when they are requested (dynamic web pages). Client-side scripting can make web pages more responsive to user input once on the client browser.

13.2.1 Color, Typography, Illustration and Interaction

Web pages usually include information as to the colors of text and backgrounds and very often also contain links to images and sometimes other types of media to be included in the final view. Layout, typographic and color-scheme information is provided by Cascading Style Sheet (CSS) instructions, which can either be embedded in the HTML or can be provided by a separate file, which is referenced from within the HTML. The latter case is especially relevant where one lengthy style sheet is relevant to a whole website: due to the way HTTP works, the browser will only download it once from the web server and use the cached copy for the whole site. Images are stored on the web server as separate files, but again HTTP allows for the fact that once a web page is downloaded to a browser, it is quite likely that related files such as images and style sheets will be requested as it is processed. An HTTP 1.1 web server will maintain a connection with the browser until all related resources have been requested and provided. Web browsers usually render images along with the text and other material on the displayed web page.

13.2.2 Dynamic Behavior

Client-side computer code such as JavaScript or code implementing Ajax techniques can be provided either embedded in the HTML of a web page or, like CSS style sheets, as separate, linked downloads specified in the HTML. These scripts may run on the client computer, if the user allows.



Did u know?

Each day when browsing the Internet, we visit a lot of websites, some more complex, others — just simple personal pages. The term “website” represents a summary of all the content you have put online — each file takes part in what the website represents, and The driving power behind the website, the pillars that hold it together, are the web pages.

13.3 Website

The location bar (in Netscape Navigator) or Address bar (in IE) typically shows the address for the last page you accessed. You can also use the location bar to access a specific page by typing the address for that page into the location bar.

To enter an address in the location bar follow these steps:

Notes

1. Point and click in the location bar. Delete the address that appears there.
2. Type a new address. such as <http://www.hotmail.com>
3. Press the **Return** key

To the right hand side of the Location bar, there is a button labeled with a triangle. By clicking on the triangle, you will get a drop-down menu of addresses that you have visited recently.



Notes

Many browsers no longer require you to type "http://www."

13.3.1 Book Marking

In web terminology, a bookmark is a record of Web page address. If you want to visit a page again and again or to visit again a browsing page or to find the page again you can bookmark it Most browsers also allow you to organize your bookmarks into a directory, similar to the file folder directories in Windows. The processes for creating, organizing, and accessing your bookmarks varies depending on the browser that you are using. Here are a few examples of how to bookmark using Netscape Navigator 3, and Microsoft Internet Explorer 4.

Creating bookmarks:

1. Select the **Bookmarks** menu.
2. Select "**Add Bookmark**" from this menu

Organizing bookmarks:

1. Select the **Bookmarks** menu.
2. Select "**Go to Bookmarks**" from this menu. The Bookmarks window will open.
3. In the **Bookmarks** window, you can add or delete bookmarks, arrange bookmarks into file folders, and place separators between groups of bookmarks.

Accessing bookmarks:

1. Select the **Bookmarks** menu.
2. Select the name of your bookmark from the menu, *OR* select "**Go to Bookmarks**" and select your bookmark from your directory of bookmarks.



Notes

In Microsoft Internet Explorer, bookmarks are called "favorites".

Use your browser's find feature to search for words within the current page.

1. **Click the Edit menu and select "find"**. A dialog box will open.
2. **Type the text that you want to find into the dialog box**. This is a verbatim search, so you might want to keep your text brief. Notice that you may also choose whether or not to make the search case-specific, and you can choose to search the page upward or downward.

Notes

3. Click **“find Next”**. If the browser finds matching text, it will highlight the text and scroll to the text if the text appears outside the current viewing area. Clicking the **“find Next”** button again will find the next occurrence of this text.

To Save and Print

This section explains some of the ways that you can take information out of the Web.

To Copy Text and Images

There are several browser-specific ways to save text and images. The following techniques work in most browsers.

Copying text: To copy text, simply highlight the text using the cursor, and then click the Edit menu and select **“Copy”**. You can then paste the information into another application, such as a Word-processing application, using the paste function of that application.

Saving images: Saving images work slightly differently for Windows. Windows users should click on the image that they want to copy using their right mouse button. A menu will appear near the cursor. Select **“Save image as..,”** (or **“Save Picture As..”** if you’re using Microsoft) from the menu. Your browser will prompt you to pick a file name for the image.



The Web is a form of publishing. Intellectual property laws apply to it. If you intend to publish information that you have taken from the Web, be certain to give reference of the original document source and/or obtain copyright permission from the appropriate source.

13.3.2 Printing

You can print Web pages to paper for the hard copy; however, before printing anything for the first time, you should probably click on the file menu and select **“Page Setup”**. The interface for setting up print options varies widely between browsers. Here are some general guidelines for printing options:

- Turn backgrounds off. Printing backgrounds will make your printed copy difficult to read.
- Set text to black.
- Some Web browsers have an option for printing frame pages as they appear on screen versus printing one page within a frameset. Be aware of how this option is set before printing.
- Most browsers have a **“Print preview”** option in the file menu. Print preview will allow you to view how your printed pages will look, and you will know if some pages aren’t worth printing.

After printing a page, you may notice that your browser has printed some useful information in the page margins. This information is particularly useful if you want to revisit the page later, or refer to the page in a bibliography. Typically, the information will be arranged as follows:

- Web page title will appear in the top left corner of the page.
- URL (address/location) will appear in the top right corner of the page.
- The total number of printed pages will appear in the lower left corner of the page.
- The date and time of printing will appear in the lower right corner of the page.

13.3.3 To Download

Notes

“Downloading” is a term used to describe the process of saving information, from a server connected to the Web, to your computer—without viewing the information. Typically, files that you download are not Web-viewable resources. Often these files are software applications such as Web browsers. Downloading can take a long time, depending on the size of the file and the speed of your Internet connection.

To download a file, simply double click on a link to a download file. These links are usually clearly labeled. If you accidentally begin to download a file, or if the download is going to take longer than you are prepared to wait, you may cancel the download by clicking on a cancel button on the download dialog box.

13.3.4 To Personalise the Display

You can change the look of your browser and how it works by changing preferences. If you want to change your home page to a different address, hide your tool bar, or increase the size of the text on your screen. You can do it by following the procedures below. Your browser has more preference options than this section will teach you to use. The directions below teach you some of the more commonly used preferences. Before altering text, link, or background preferences, consider the affect that changing these preferences may have on how your browser displays pages. Preferences for display settings, such as text, size and color, will supersede the settings programmed into the page. Changing these settings may alter page layout, having an adverse effect on design and making it harder to find the information that you are looking for. Changing color settings may obscure text or other information entirely, for example, by setting text and background to the same color. If you would like more space on the screen to view the content of pages, you may want to consider changing your toolbar button preferences to “text only”. Hiding some of your toolbars will give you even greater viewing space on the screen.

1. Click at either of the browsers ; **Internet Explorer** or **Netscape Navigator** in the main windows icons. The explorer version will appear on the screen.
2. A window with an address `http://home.microsoft.com/` will appear. Change this address and open the following sites one by one:
 - (a) `www.hinducollege.edu`
 - (b) `www.rgu.ac.uk`
 - (c) `www.timesofindia.com`
 - (d) `www.britcoun.org`
 - (e) `www.af.mil`
 - (f) `www.doe.gov`
 - (g) `www.webduniya.com`

13.4 Browsers

A web browser can have a Graphical User Interface, like Internet Explorer, Mozilla Firefox, Chrome and Opera, or can be text-based, like Lynx or Links. Web users with disabilities often use assistive technologies and adaptive strategies to access web pages. Users may be color blind, may or may not want to use a mouse perhaps due to repetitive stress injury or motor-neurone problems, may be deaf and require audio to be captioned, may be blind and using a screen reader or braille display, may need screen magnification, etc. Disabled and able-bodied users may disable the download and viewing of images and other media,

Notes

to save time, network bandwidth or merely to simplify their browsing experience. Users of mobile devices often have restricted displays and bandwidth. Anyone may prefer not to use the fonts, font sizes, styles and color schemes selected by the web page designer and may apply their own CSS styling to the page. The World Wide Web Consortium (W3C) and Web Accessibility Initiative (WAI) recommend that all web pages should be designed with all of these options in mind.

13.4.1 Elements

A web page, as an information set, can contain numerous types of information, which is able to be seen, heard or interact by the end user:

Perceived (rendered) information:

- Textual information: with diverse render variations.
- Non-textual information:
 - ❖ Static images may be raster graphics, typically GIF, JPEG or PNG; or vector formats such as SVG or Flash.
 - ❖ Animated images typically Animated GIF and SVG, but also may be Flash, Shockwave, or Java applet.
 - ❖ Audio, typically MP3, ogg or various proprietary formats.
 - ❖ Video, WMV (Windows), RM (Real Media), FLV (Flash Video), MPG, MOV (QuickTime).
- Interactive information
 - ❖ For “on page” interaction:
 - ◆ **Interactive text.**
 - ◆ **Interactive illustrations:** ranging from “click to play” images to games, typically using script orchestration, Flash, Java applets, SVG, or Shockwave.
 - ◆ **Buttons:** forms providing alternative interface, typically for use with script orchestration and DHTML.
 - ❖ For “between pages” interaction:
 - ◆ **Hyperlinks:** standard “change page” reactivity.
 - ◆ **Forms:** providing more interaction with the server and server-side databases.

Internal (hidden) information:

- Comments
- Linked Files through Hyperlink (Like DOC,XLS,PDF,etc).
- Metadata with semantic meta-information, Charset information, Document Type Definition (DTD), etc.
- Diagramation and style information: information about rendered items (like image size attributes) and visual specifications, as Cascading Style Sheets (CSS).
- Scripts, usually JavaScript, complement interactivity and functionality.

The web page can also contain dynamically adapted information elements, dependent upon the rendering browser or end-user location (through the use of IP address tracking and/or “cookie” information).

From a more general/wide point of view, some information (grouped) elements, like a

navigation bar, are uniform for all website pages, like a standard. These kind of “website standard information” are supplied by technologies like web template systems.

Notes

13.4.2 Rendering

Web pages will often require more screen space than is available for a particular display resolution. Most modern browsers will place a scrollbar (a sliding tool at the side of the screen that allows the user to move the page up or down, or side-to-side) in the window to allow the user to see all content. Scrolling horizontally is less prevalent than vertical scrolling, not only because such pages often do not print properly, but because it inconveniences the user more so than vertical scrolling would (because lines are horizontal; scrolling back and forth for every line is much more inconvenient than scrolling after reading a whole screen; also most computer keyboards have page up and down keys, and many computer mice have vertical scroll wheels, but the horizontal scrolling equivalents are rare).

When web pages are stored in a common directory of a web server, they become a website. A website will typically contain a group of web pages that are linked together, or have some other coherent method of navigation. The most important web page to have on a website is the index page. Depending on the web server settings, this index page can have many different names, but the most common is index.html. When a browser visits the homepage for a website, or any URL pointing to a directory rather than a specific file, the web server will serve the index page to the requesting browser. If no index page is defined in the configuration, or no such file exists on the server, either an error or directory listing will be served to the browser.

A web page can either be a single HTML file, or made up of several HTML files using frames or Server Side Includes (SSIs). Frames have been known to cause problems with web accessibility, copyright, navigation, printing and search engine rankings, and are now less often used than they were in the 1990s. Both frames and SSIs allow certain content which appears on many pages, such as page navigation or page headers, to be repeated without duplicating the HTML in many files. Frames and the W3C recommended alternative of 2000, the <object> tag, also allow some content to remain in one place while other content can be scrolled using conventional scrollbars. Modern CSS and JavaScript client-side techniques can also achieve all of these goals and more.

When creating a web page, it is important to ensure it conforms to the World Wide Web Consortium (W3C) standards for HTML, CSS, XML and other standards. The W3C standards are in place to ensure all browsers which conform to their standards can display identical content without any special consideration for proprietary rendering techniques. A properly coded web page is going to be accessible to many different browsers old and new alike, display resolutions, as well as those users with audio or visual impairments.

13.4.3 Web Browser Environment

Browsers (or WWW Clients) enable to use one’s computer to look at World Wide Web (WWW) documents. All the top browsers are available in different versions to suit common operating systems. For browsing a website we should have a web browser which is a software application. There are two basic ways in which the browsers are classified:

They are as follows:

- (i) Non-Graphical Web Browser Lynx is a program that allows one to access the World Wide Web without graphics.
- (ii) Graphical Web Browser are the two major graphic web browsers.

Notes

Figure 13.2: Netscape Navigator Browser Shows a Site of home.netscape.com



They are much more user-friendly web browsing software programs. They require more memory than a system on which lynx can run. These web browsers allow people to explore the Internet, a worldwide network of sites from which people can read information, view graphics, hear sound, if the computer is equipped with the appropriate technology. You can print information, download it to your computer or disk, save your favorite Internet sites as a "bookmark" which can reside in a folder on your computer or save your bookmarks on a disk to have a portable list of sites. The two mentioned software; Internet Explorer and Netscape Navigator are the most widely used browsers. They are very similar in function. The latest versions of each are rich in useful features. These two browsers alone more or less have covered the entire market.

Figure 13.3: Internet Explorer Browser Showing a Site of msn.com



Netscape Navigator was developed by Netscape Communications and was officially released in December 1994. It has online help available from the help menu and provides one of the best web interfaces because of its features. It is also one of the fastest web browsers under windows. This software is used for web designing because of its window based concept.

Microsoft Internet Explorer is one of the latest Internet browsers explored by Microsoft. It has a lot of features including ability to browse web documents with ease; create web documents (HTML) from scratch, convert a word documents to HTML and convert at HTML document to word document. HTML is an abbreviation for Hyper Text Markup Language.

Although there are differences between the two mentioned browsers, Internet Explorer and Netscape Navigator their function in browsing the Web and the basic interface design is similar.

The Banner

The interface for each of these programs consists of a banner (including buttons, menus, one text area, and a logo) and below that banner is an open area that displays Web pages.

The banners for both these browsers are shown in Figure 13.4 (a) and (b).

Figure 13.4 (a): The Banner of Netscape Navigator 3

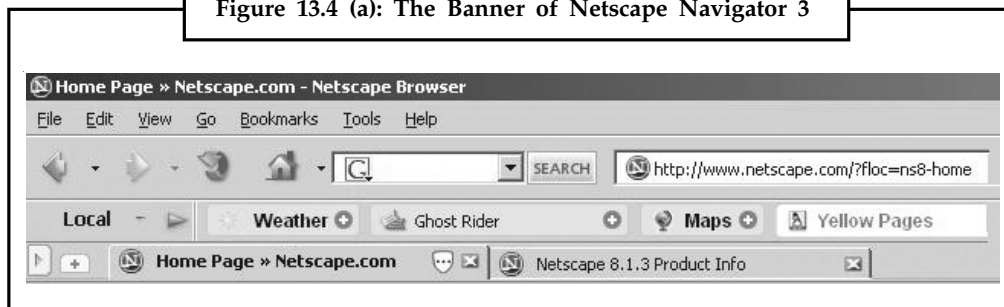

Figure 13.4 (b): The Banner of Microsoft Internet Explorer 4



The banner is classified into the following three basic sections:

- (i) The Menu Bar,
- (ii) The Toolbar,
- (iii) The Location or Address bar.

The Menu Bar

The menu bar is a list of terms that you can click. Clicking on these terms will display menus from which you can select actions to perform.

Notes

Figure 13.5: Menu Bar from Netscape Navigator



The Toolbar

The toolbar (shown below in Figure 13.6 is from Netscape Navigator 3) is a series of buttons that you can click to quickly access common tasks.

Figure 13.6: The Tool Bar of Netscape Navigator



The Location Bar

The location bar (from Netscape Navigator 3, shown in Figure 13.7) displays the address of the last page that the browser has loaded. You can also use the location bar to enter the addresses of a page where you want to go.

Figure 13.7: The Location Bar from Netscape Navigator



Opening a New Browser Window

Whenever you want to open a new browser window you will have to follow these instructions: Click on the **file** menu, and select “**New**” from this menu. A new browser window will open on the screen. Use this new window for testing Web browsing techniques in the laboratory.

Navigation Within a Page

Most of the navigation that you will do in browsing the involves the use of mouse. The basic concept of using the should be clear to you. So, let us just make sure that we are the same terminology for the same actions and objects that in the mouse.

Cursor: This is the object that you can move around screen by moving your mouse.

Pointing: This is the act of moving the cursor over an on screen.

Clicking: This is the act of pressing the button on mouse, usually after pointing.

Selecting: The selection is done by dragging the cursor over the item and then releasing it in the Windows operating system.

Highlighting: Highlighting is the act of clicking the cursor and dragging it over a section of text or images to highlight.

Scrolling: This is a method of viewing hidden parts of a page that is too large to be viewed on screen all at once. To scroll, point and click on either the arrows or the bar of a scrollbar. Scrollbars are shown in Figure 13.8.

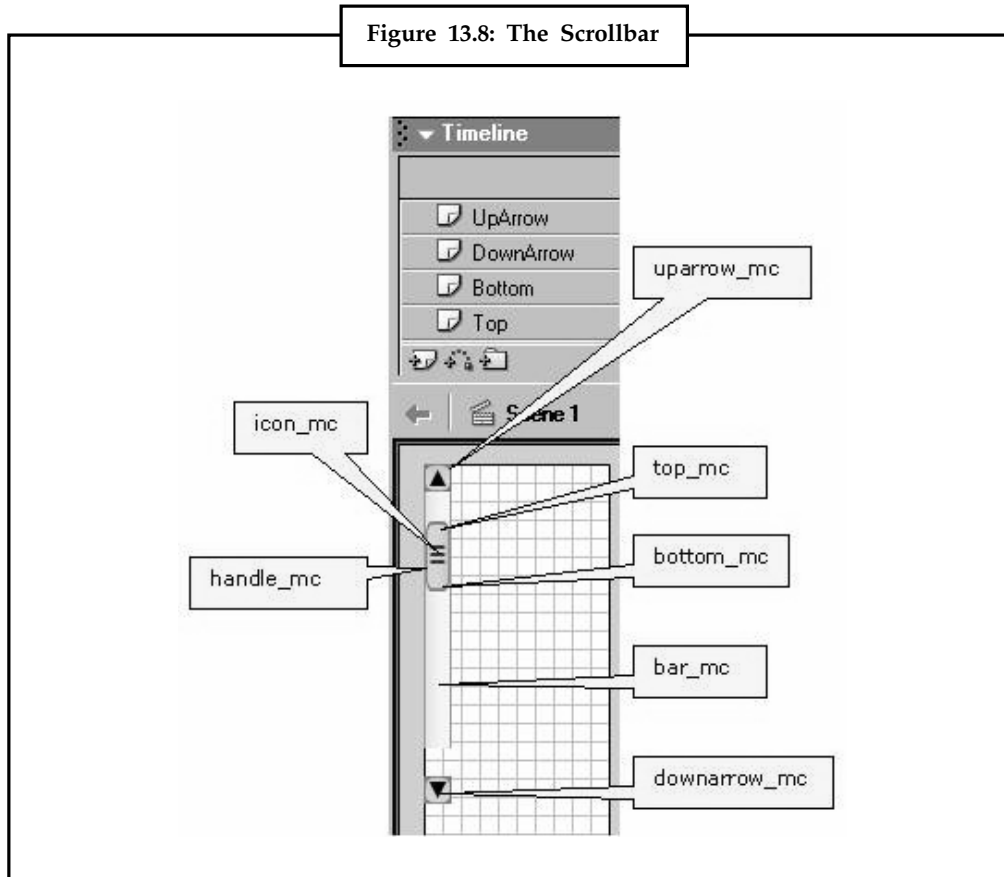

Drop-down menus: Drop-down menus allow you to select a choice from a list of information in a small space. Click on the triangle to display the list. Drop-down menus is shown in Figure 13.9.

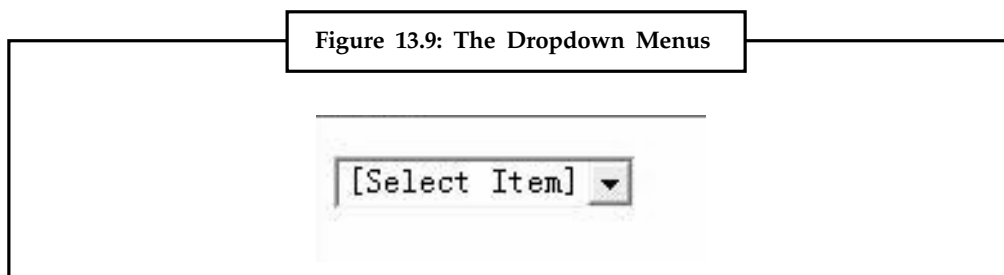

Netscape Navigator was developed by Netscape Communications and was officially released in **December 1994**. It has online help available from the help menu and provides one of the best web interfaces because of its features. It is also one of the fastest web browsers under windows. This software is used for web designing because of its window based concept.

Microsoft Internet Explorer is one of the latest Internet browsers explored by Microsoft. It has a lot of features including ability to browse web documents with ease; create web documents (HTML) from scratch, convert a word documents to HTML and convert at HTML document to word document. HTML is an abbreviation for Hyper Text Markup Language.

13.5 URL

Typically, web pages today are becoming more dynamic. A dynamic web page is one that is created server-side when it is requested, and then served to the end-user. These types of web pages typically do not have a permalink, or a static URL, associated with them. Today, this can be seen in many popular forums, online shopping, and even on Wikipedia. This practice is intended to reduce the amount of static pages in lieu of storing the relevant web page information in a database. Some search engines may have a hard time indexing a web page that is dynamic, so static web pages can be provided in those instances.

13.5.1 Viewing

In order to graphically display a web page, a web browser is needed. This is a type of software that can retrieve web pages from the Internet. Most current web browsers include the ability to view the source code. Viewing a web page in a text editor will also display the source code, not the visual product.

13.5.2 Creation

To create a web page, a text editor or a specialized HTML editor is needed. In order to upload the created web page to a web server, traditionally an FTP client is needed.

The design of a web page is highly personal. A design can be made according to one's own preference, or a premade web template can be used. Web templates let web page designers edit the content of a web page without having to worry about the overall aesthetics. Many people publish their own web pages using products like Tripod, or Angelfire. These web publishing tools offer free page creation and hosting up to a certain size limit. Other ways of making a web page is to download specialized software, like a Wiki, CMS, or forum. These options allow for quick and easy creation of a web page which is typically dynamic.

13.5.3 Saving

While one is viewing a web page, a copy of it is saved locally; this is what is being viewed. Depending on the browser settings, this copy may be deleted at any time, or stored indefinitely, sometimes without the user realizing it. Most GUI browsers provide options for saving a web page more permanently. These may include:

- Save the rendered text without formatting or images, with hyperlinks reduced to plain text
- Save the HTML as it was served—Overall structure preserved, but some links may be broken
- Save the HTML with relative links changed to absolute ones so that hyperlinks are preserved
- Save the entire web page—All images and other resources including stylesheets and scripts are downloaded and saved in a new folder alongside the HTML, with links to them altered to refer to the local copies. Other relative links changed to absolute
- Save the HTML as well as all images and other resources into a single MHTML file. This is supported by Internet Explorer and Opera. Other browsers may support this if a suitable plugin has been installed.

Most operating systems allow applications such as web browsers not only to print the currently viewed web page to a printer, but optionally to "print" to a file that can be viewed or printed later. Some web pages are designed, for example by use of CSS, so that hyperlinks, menus and other navigation items, which will be useless on paper, are rendered into print

with this in mind. Sometimes, the destination addresses of hyperlinks may be shown explicitly, either within the body of the page or listed at the end of the printed version. Web page designers may specify in CSS that non-functional menus, navigational blocks and other items may simply be absent from the printed version.

13.5.4 Getting Started of Web Page

There are basically two ways to make a web page. The first way is to create the page(s) offline and then upload them to Internet Service Provider (ISP) via FTP. The second way is to create web page(s) online using a Telnet program by accessing UNIX account.

For creating web page(s) offline, do so in any text editing or word processing document. Make sure that when you save your document, you save it as a "text", "plain text" or "text only" document. Otherwise it will not be read properly by a web browser. Once you have created page(s), it will need to contact ISP about how to go about uploading them to server.

In case of UNIX account, you can create your web page(s) online. First need to get a program that can access your UNIX account. Recommended Telnet for the Mac or Ewan for Windows 95/98.

Once we can access of account, we need to make a new directory called "public_html". We can do this by typing:

```
mkdir public_html
```

After this, change directory to this new directory called "public_html".

```
cd public_html
```

We can make other directories, one for all the web pages that we make, and one for all of the graphics that we have. Follow the same steps as above to do this.

Next, we need to think of a filename for page (this is not a title, but what will be in the URL). A common filename for a main web page, is "index". Once we have decided on this, add ".html" to the end of it. Then type (i.e.)

```
pico index.html
```

Of course, use page's filename, instead of this one. Next, we need to gain some knowledge of the many HTML commands. Follow the index below, to decide what to put on page, and how to do it. Once we have gotten started, exit page. We can do this by pressing **control-x**. Then we need to type

```
chmod 744 index.html
```

Only do this with the filename of page. We only need to do this the very first time that we leave web page. This command will make sure that nobody else can delete page. We will need to do this to any other pages that we make in the future. Then, look at page on the WWW. Lets say that server is "www.domain.com", if username is "username", and the name of page is "index.html". The URL would normally be:

```
http://www.domain.com/~username/index.html
```

However, we will need to contact ISP for URL.

If we have made separate directories for pages and graphics, then we need to include that in the URL also. Lets say that you made a directory for all of your web pages, called "Pages". The new URL would be: **http://www.domain.com/~username/Pages/index.html**

Notes

Title

The first thing to put on web page, is a title. The title is what will show up in the very top of the window. Let's say that title is going to be "SNGT's Web Page", we would type:

<title>SNGT's Web Page</title>

In HTML, every command is surrounded by <'s, and >'s. And in most commands, we need to tell the web browser when to end this command. Do this by putting a back slash (/) in front of the ending command, as in above. Since HTML isn't case sensitive, <title> is the same as <TITLE>, which is the same as <TiTLe>. Next, we need to decide what we want to put on page. Text, links, graphics, and text fields, are just a few ideas. Follow the table of contents above to decide how, and what to put on page.

Text

Headings

HTML has six levels of headings, numbered 1 through 6, with 1 being the largest. Headings are displayed in larger, or smaller fonts, and usually bolder. If we wanted to type "Hello", this is what we would type for each heading, and what the outcome is:

<h1>Hello</h1>

Hello

<h2>Hello</h2>

Hello

<h3>Hello</h3>

Hello

<h4>Hello</h4>

Hello

<h5>Hello</h5>

Hello

<h6>Hello</h6>

Hello

Paragraphs

Whenever we have more than a sentence of writing, we should have paragraphs.

<P>This is a web page. How do you like what I've done? Please e-mail me with any suggestions at a@a.com</P>

The outcome is:

This is a web page. How do you like what I've done? Please e-mail me with any suggestions at a@a.com

Lists

Notes

There are two types of lists that can be made in HTML, dotted, and numbered. To make a dotted list of: red, orange, green, blue, purple, black, and brown, type:

```
<UL>
<LI> red
<LI> orange
<LI> green
<LI> blue
<LI> purple
<LI> black
<LI> brown
</UL>
```

The result is:

- red
- orange
- green
- blue
- purple
- black
- brown

To make a numbered list of: red, orange, green, blue, purple, black, and brown, type:

```
<OL>
<LI> red
<LI> orange
<LI> green
<LI> blue
<LI> purple
<LI> black
<LI> brown
</OL>
```

The result looks like:

1. red
2. orange
3. green
4. blue
5. purple

Notes

- 6. black
- 7. brown

Forced Line Breaks

There are many cases in which we want to end typing on one line, and start on the next. To do this, we can use a simple HTML command. This is one of the few commands that we don't have to put an ending command on. Let's say that we wanted to say "Hello, how are you?", but with each word on a separate line. All we have to type is:

Hello,
how
are
you?

The outcome is:

Hello,
how
are
you?

Horizontal Rules

Every now and then, we might want to have a horizontal rule, or line in your page. Horizontal rules can be many different sizes and lengths. We can also have the line be solid black, by typing NOSHADE. Here are several examples of sizes and widths, and what the outcome is:

<HR SIZE=1 WIDTH=100%>
<HR SIZE=5 WIDTH=50%>
<HR SIZE=25 WIDTH=75%>
<HR SIZE=3 WIDTH=100%>
<HR NOSHADE SIZE=1 WIDTH=100%>
<HR NOSHADE SIZE=3 WIDTH=100%>
<HR NOSHADE SIZE=10 WIDTH=20%>

Character Formatting

We may want to format some of your text differently than others using text styles. There are several types of styles of text that you can use: **bold**, *italic*, underline, ~~strikeout~~, ^{superscript}, _{subscript}, teletype, and blinking text are examples. To do these styles, surround text with the following commands:

, for **bold**
<i>, </i> for *italic*
<u>, </u> for underlined
<strike>, <strike> for ~~strikeout~~
[,] for ^{superscript}
_, for _{subscript}
<tt>, </tt> for teletype
<blink>, </blink> for blinking text (very annoying)

Links to Specific Sections

Notes

Sometimes, you might want to have a link that will take you further down a page, or to a certain section of another page. If you click on the colored text and it takes you to that section. To do this, you need to do two things. The first, is to make the link, and the second, is to make where the link will lead to.



You cannot make links to specific sections within a different document unless either you have write permission to the coded source of that document or that document already contains in-document named links.

- (1) To make the actual link, think of a name for the certain spot. Let's say you are going to call it "spot". If this certain spot is on the same page that the link is, you would type:

```
<A HREF="#spot">Colored Text
```

Otherwise, you would add "#spot" to the end of the URL.

- (2) Now, you need to make where the link will take you. Go to the spot where you want the link to take you, and type:

```
<A NAME = "spot">
```

Mailto Links

Most people like to have a link on their web page that automatically sends e-mail to an address. If you want to do this, and your name is XYZ, and your e-mail address is a@a.com, type:

```
<A HREF="mailto:a@a.com">XYZ</a>
```

Here is the result of typing this:

13.6 HTML

HTML, which stands for **Hyper Text Markup Language**, is the predominant markup language for web pages. HTML is the basic building-blocks of webpages.

HTML is written in the form of HTML elements consisting of *tags*, enclosed in angle brackets (like <html>), within the web page content. HTML tags normally come in pairs like <h1> and </h1>. The first tag in a pair is the *start tag*, the second tag is the *end tag* (they are also called opening tags and closing tags).

The purpose of a web browser is to read HTML documents and compose them into visual or audible web pages. The browser does not display the HTML tags, but uses the tags to interpret the content of the page.

HTML elements form the building blocks of all websites. HTML allows images and objects to be embedded and can be used to create interactive forms. It provides a means to create structured documents by denoting structural semantics for text such as headings, paragraphs, lists, links, quotes and other items. It can embed scripts in languages such as JavaScript which affect the behavior of HTML webpages.

13.6.1 Data Types

HTML defines several data types for element content, such as script data and stylesheet data, and a plethora of types for attribute values, including IDs, names, URIs, numbers, units of

Notes

length, languages, media descriptors, colors, character encodings, dates and times, and so on. All of these data types are specializations of character data.

13.6.2 Document Type Declaration

HTML documents are required to start with a Document Type Declaration (informally, a “doctype”). In browsers, the doctype helps to define the rendering mode—particularly whether to use quirks mode.

The original purpose of the doctype was to enable parsing and validation of HTML documents by SGML tools based on the Document Type Definition (DTD). The DTD to which the DOCTYPE refers contains a machine-readable grammar specifying the permitted and prohibited content for a document conforming to such a DTD. Browsers, on the other hand, do not implement HTML as an application of SGML and by consequence do not read the DTD. HTML5 does not define a DTD, because of the technology’s inherent limitations, so in HTML5 the doctype declaration, `<!doctype html>`, does not refer to a DTD.

An example of an HTML 4 doctype is

```
<!DOCTYPE HTML PUBLIC "-//W3C//DTD HTML 4.01//EN" "http://www.w3.org/TR/html4/strict.dtd">
```

This declaration references the DTD for the ‘strict’ version of HTML 4.01. SGML-based validators read the DTD in order to properly parse the document and to perform validation. In modern browsers, a valid doctype activates standards mode as opposed to quirks mode.



Web pages are written in HTML (hypertext markup language) and are translated by your Web browser. Web pages can either be static or dynamic. Static pages show the same content each time they are viewed. Dynamic pages have content that can change each time.

13.7 Internet Service Provider (ISP)

An **Internet service provider (ISP)** is a company that provides access to the Internet, hosts data, or does both. Access ISPs connect customers to the Internet using copper, wireless or fiber connections. Hosting ISPs lease server space for smaller businesses and host other people servers (colocation). Transit ISPs provide large tubes for connecting hosting.

13.7.1 Access ISPs

ISPs employ a range of technologies to enable consumers to connect to their network.

For users and small businesses, the most popular options include dial-up, DSL (typically Asymmetric Digital Subscriber Line, ADSL), broadband wireless, cable modem, fiber to the premises (FTTH), and Integrated Services Digital Network (ISDN) (typically basic rate interface). For customers with more demanding requirements, such as medium-to-large businesses, or other ISPs, DSL (often SHDSL or ADSL), Ethernet, Metro Ethernet, Gigabit Ethernet, Frame Relay, ISDN (BRI or PRI), ATM, satellite Internet access and synchronous optical networking (SONET) are more likely to be used.

Internet connectivity options from end-user to Tier 3/2 ISP’s

Typical home user connection

- Broadband wireless access

- Cable Internet
- Dial-up
 - ❖ ISDN
 - ❖ Modem
- DSL
- FTTH
- Wi-Fi

Typical business-type connection

- DSL
- Ethernet technologies
- Leased line
- SHDSL

13.7.2 Locality

When using a dial-up or ISDN connection method, the ISP cannot determine the caller's physical location to more detail than using the number transmitted using an appropriate form of Caller ID; it is entirely possible to e.g. connect to an ISP located in Mexico from the USA. Other means of connection such as cable or DSL require a fixed registered connection node, usually associated at the ISP with a physical address.

13.7.3 Hosting ISPs

Hosting ISPs routinely provide email, FTP, and web-hosting services. Other services include virtual machines, clouds, or entire physical servers where customers can run their own custom software.

13.7.4 Transit ISPs

Just as their customers pay them for Internet access, ISPs themselves pay upstream ISPs for Internet access. An upstream ISP usually has a larger network than the contracting ISP and/or is able to provide the contracting ISP with access to parts of the Internet the contracting ISP by itself has no access to.

In the simplest case, a single connection is established to an upstream ISP and is used to transmit data to or from areas of the Internet beyond the home network; this mode of interconnection is often cascaded multiple times until reaching a Tier 1 carrier. In reality, the situation is often more complex. ISPs with more than one point of presence (PoP) may have separate connections to an upstream ISP at multiple PoPs, or they may be customers of multiple upstream ISPs and may have connections to each one of them at one or more point of presence.

13.7.5 Peering

Main article: Peering

ISPs may engage in peering, where multiple ISPs interconnect at peering points or Internet exchange points (IXs), allowing routing of data between each network, without charging one another for the data transmitted—data that would otherwise have passed through a third upstream ISP, incurring charges from the upstream ISP.

Notes

ISPs requiring no upstream and having only customers (end customers and/or peer ISPs) are called Tier 1 ISPs.

Network hardware, software and specifications, as well as the expertise of network management personnel are important in ensuring that data follows the most efficient route, and upstream connections work reliably. A tradeoff between cost and efficiency is possible.

13.7.6 Derivatives

The following are not a different type of the above ISPs, rather they are derivatives of the 3 core ISP types. A VISP is reselling either access or hosting services. Free ISPs are similar, but they just have a different revenue model.

Virtual ISP

A Virtual ISP (VISP) is an operation which purchases services from another ISP (sometimes called a “wholesale ISP” in this context-which allow the VISP’s customers to access the Internet using services and infrastructure owned and operated by the wholesale ISP.

Free ISP

Free ISPs are Internet Service Providers (ISPs) which provide service free of charge. Many free ISPs display advertisements while the user is connected; like commercial television, in a sense they are selling the users’ attention to the advertiser. Other free ISPs, often called freenets, are run on a nonprofit basis, usually with volunteer staff.



Case Study

History of the Internet

The History of the Internet has precursors that date back to the 19th century, especially the telegraph system, more than a century before the digital Internet became widely used in the second half of the 1990s. The concept of data communication - transmitting data between two different places, connected via some kind of electromagnetic medium, such as radio or an electrical wire - actually predates the introduction of the first computers. Such communication systems were typically limited to point to point communication between two end devices. Telegraph systems and telex machines can be considered early precursors of this kind of communication.

Early computers used the technology available at the time to allow communication between the central processing unit and remote terminals. As the technology evolved, new systems were devised to allow communication over longer distances (for terminals) or with higher speed (for interconnection of local devices) that were necessary for the mainframe computer model. Using these technologies it was possible to exchange data (such as files) between remote computers. However, the point to point communication model was limited, as it did not allow for direct communication between any two arbitrary systems; a physical link was necessary. The technology was also deemed as inherently unsafe for strategic and military use, because there were no alternative paths for the communication in case of an enemy attack.

As a response, several research programs started to explore and articulate principles of communications between physically separate systems, leading to the development of the packet switching model of digital networking. These research efforts included those of

the laboratories of Vinton G. Cerf at Stanford University, Donald Davies (NPL), Paul Baran (RAND Corporation), and Leonard Kleinrock at MIT and at UCLA. The research led to the development of several packet-switched networking solutions in the late 1960s and 1970s, including ARPANET, Telnet, and the X.25 protocols. Additionally, public access and hobbyist networking systems grew in popularity, including *unix-to-unix copy* (UUCP) and FidoNet. They were however still disjointed separate networks, served only by limited gateways between networks. This led to the application of packet switching to develop a protocol for internetworking, where multiple different networks could be joined together into a super-framework of networks. By defining a simple common network system, the Internet Protocol Suite, the concept of the network could be separated from its physical implementation. This spread of *internetworking* began to form into the idea of a global network that would be called the Internet, based on standardized protocols officially implemented in 1982. Adoption and interconnection occurred quickly across the advanced telecommunication networks of the western world, and then began to penetrate into the rest of the world as it became the de-facto international standard for the global network. However, the disparity of growth between advanced nations and the third-world countries led to a digital divide that is still a concern.

Questions:

1. How was the Internet invented?
2. What are the benefits of Internet?

13.8 Summary

- In this we discuss about the role of internet and its user in various different fields as referred by scientists as an 'ocean' to 'surf', 'side' or 'navigate' the net.
- Web page may be retrieved from a local computer or from remote web senses.
- Record of web page address is a book marking.
- In elements web page, can contain numerous types of information, which is able to be seen.
- Graphical web browser are user friendly web browsing programs.
- Lynx is the program that allows one to access the World Wide Web without graphic is used by Non-Graphical web Browser.

13.9 Keywords

Banner: The interface for each of these programs consists of a banner (including buttons, menus, one text area, and a logo) and below that banner is an open area that displays Web pages.

Bookmark: In web terminology, a bookmark is a record of Web page address.

Browsers: The web browser is a medium that enable to use one's computer to look at World Wide Web (WWW) documents.

Graphical Web browser: It is a Lynx program which allows one to access world wide web with graphic.

HTML: It stands for Hyper Text Markup Language, is the predominant markup language for web page. It is the basic building block of webpages.

ISP: ISP or internet service provider is a company that provides access to the Internet, host data or does both.

Notes

Non-graphical Web browser: It is a lynx program that allows one to access the World Wide Web without graphics.



Lab Exercise

1. Explain video teleconference.
2. Explain Website.

13.10 Self-Assessment Questions

1. A list of terms that displays menus to select actions to perform is located on:
(a) Menu Bar (b) Tool Bar
(c) Location Bar (d) Address Bar
2. A series of buttons to quickly access common tasks is located on:
(a) Menu Bar (b) Tool Bar
(c) Location Bar (d) Address Bar
3. The bar that displays the address of the last page that the browser has loaded is:
(a) Menu Bar (b) Tool Bar
(c) Location Bar (d) Standard Bar
4. To return to a default page, we click on:
(a) Home button (b) Back button
(c) Forward button (d) Stop button
5. What are the main elements of a web server?
(a) Perceived information (b) Interactive information
(c) Internal information (d) All of these
6. The 'Help' option appears on a netscape navigator on
(a) Menu bar (b) Tool bar
(c) Locational address bar (d) None of these

13.11 Review Questions

1. What are the commonly used browsers?
2. Explain the difference between Lynx and Internet Explorer.
3. Explain how a banner of IE classified.
4. What is the function of a location bar in a browser?
5. Explain the significance of Book Marking.
6. Give different steps to open hotmail.com home page.
7. How can you search for computer books available on the internet in India?
8. What are the main components of Internet browsers?

9. What is the use of Internet Service Providers (ISP)?
10. What is the significance of HTML in Internet Browsers?

Notes

Answers for Self-Assessment Questions

- | | | | |
|--------|--------|--------|--------|
| 1. (a) | 2. (a) | 3. (c) | 4. (b) |
| 5. (d) | 6. (a) | | |

13.12 Further Reading



Books

Excellence in Computer Education by Dr. C. K. Seth.



Online link

www.webopedia.com/index.php/TERM/I/internet.html

Unit 14: Web Server Applications

CONTENTS

Objectives

Introduction

- 14.1 Web Server
 - 14.1.1 Common Features
 - 14.1.2 Path Translation
 - 14.1.3 Load Limits
 - 14.1.4 Kernel-mode and User-mode Web Servers
 - 14.1.5 Overload Causes
 - 14.1.6 Overload Symptoms
 - 14.1.7 Anti-overload Techniques
 - 14.1.8 Mark et Structure
- 14.2 E-mail
- 14.3 Instant Messaging (IM)
- 14.4 Internet Telephony
- 14.5 Videoconference
 - 14.5.1 Conferencing Layers
 - 14.5.2 Multipoint Videoconferencing
 - 14.5.3 Videoconferencing Modes
 - 14.5.4 Echo Cancellation
 - 14.6.5 Problems
- 14.6 Summary
- 14.7 Keywords
- 14.8 Review Questions
- 14.9 Self-Assessment Questions
- 14.10 Further Reading

Objectives

Notes

After studying this unit, you will be able to:

- Understand the Web Server
- Explain the use and concept of E-mail
- Discuss instant messaging
- Explain internet telephony
- Understand video conference

Introduction

A web server is the combination of computer and the program installed on it. Web server interacts with the client through a web browser. It delivers the web pages to the client and to an application by using the web browser and the HTTP protocols respectively. We can also define the web server as the package of large number of programs installed on a computer connected to Internet or intranet for downloading the requested files using File Transfer Protocol, serving e-mail and building and publishing web pages. A web server works on a client server model. A computer connected to the Internet or intranet must have a server program.

14.1 Web Server

A **web server** can be referred to as either the hardware (the computer) or the software (the computer application) that helps to deliver content that can be accessed through the Internet. The most common use of Web servers is to host Web sites but there are other uses like data storage or for running enterprise applications.

14.1.1 Common Features

1. **Virtual hosting** to serve many Web sites using one IP address.
2. **Large file support** to be able to serve files whose size is greater than 2 GB on 32 bit OS.
3. **Bandwidth throttling** to limit the speed of responses in order to not saturate the network and to be able to serve more clients.
4. **Server-side scripting** to generate dynamic Web pages, still keeping Web server and Web site implementations separate from each other.

14.1.2 Path Translation

Web servers are able to map the path component of a Uniform Resource Locator (**URL**) into:

- A local file system resource (for static requests);
- An internal or external program name (for dynamic requests).

For a static request the URL path specified by the client is relative to the Web server's root directory.

Consider the following URL as it would be requested by a client:

`http://www.example.com/path/file.html`

The client's user agent will translate it into a connection to `www.example.com` with the following HTTP 1.1 request:

Notes

GET /path/file.html HTTP/1.1

Host: www.example.com

The Web server on www.example.com will append the given path to the path of its root directory. On an Apache server, this is commonly /home/www (On UNIX machines, usually /var/www). The result is the local file system resource:

/home/www/path/file.html

The Web server then reads the file, if it exists and sends a response to the client's Web browser. The response will describe the content of the file and contain the file itself or an error message will return saying that the file does not exist or is unavailable.

14.1.3 Load Limits

A Web server (program) has defined load limits, because it can handle only a limited number of concurrent client connections (usually between 2 and 80,000, by default between 500 and 1,000) per IP address (and TCP port) and it can serve only a certain maximum number of requests per second depending on:

- its own settings;
- the HTTP request type;
- content origin (static or dynamic);
- the fact that the served content is or is not cached;
- the hardware and software limitations of the OS where it is working;

When a Web server is near to or over its limits, it becomes unresponsive.

14.1.4 Kernel-mode and User-mode Web Servers

A Web server can be either implemented into the OS kernel, or in user space (like other regular applications).

An in-kernel Web server (like TUX on GNU/Linux or Microsoft IIS on Windows) will usually work faster, because, as part of the system, it can directly use all the hardware resources it needs, such as non-paged memory, CPU time-slices, network adapters, or buffers.

Web servers that run in user-mode have to ask the system the permission to use more memory or more CPU resources. Not only do these requests to the kernel take time, but they are not always satisfied because the system reserves resources for its own usage and has the responsibility to share hardware resources with all the other running applications.

Also, applications cannot access the system's internal buffers, which causes useless buffer copies that create another handicap for user-mode web servers. As a consequence, the only way for a user-mode web server to match kernel-mode performance is to raise the quality of its code to much higher standards, similar to that of the code used in web servers that run in the kernel. This is a significant issue under Windows, where the user-mode overhead is about six times greater than that under Linux.

14.1.5 Overload Causes

At any time web servers can be overloaded because of:

- **Too much legitimate web traffic.** Thousands or even millions of clients connecting to the web site in a short interval, e.g., Slashdot effect;
- **Distributed Denial of Service** attacks;
- **Computer worms** that sometimes cause abnormal traffic because of millions of infected computers (not coordinated among them);

- **XSS viruses** can cause high traffic because of millions of infected browsers and/or Web servers;
- **Internet bots.** Traffic not filtered/limited on large web sites with very few resources (bandwidth, etc.);
- **Internet (network) slowdowns**, so that client requests are served more slowly and the number of connections increases so much that server limits are reached;
- **Web servers (computers) partial unavailability.** This can happen because of required or urgent maintenance or upgrade, hardware or software failures, back-end (e.g., database) failures, etc.; in these cases the remaining web servers get too much traffic and become overloaded.

14.1.6 Overload Symptoms

The symptoms of an overloaded Web server are:

- requests are served with (possibly long) delays (from 1 second to a few hundred seconds);
- 500, 502, 503, 504 HTTP errors are returned to clients (sometimes also unrelated 404 error or even 408 error may be returned);
- TCP connections are refused or reset (interrupted) before any content is sent to clients;
- in very rare cases, only partial contents are sent (but this behavior may well be considered a bug, even if it usually depends on unavailable system resources).

14.1.7 Anti-overload Techniques

To partially overcome above load limits and to prevent overload, most popular Web sites use common techniques like:

- **managing network traffic**, by using:
 - ❖ **Firewalls** to block unwanted traffic coming from bad IP sources or having bad patterns;
 - ❖ **HTTP traffic managers** to drop, redirect or rewrite requests having bad HTTP patterns;
 - ❖ **Bandwidth management** and **traffic shaping**, in order to smooth down peaks in network usage;
- deploying **Web cache** techniques;
- using different domain names to serve different (static and dynamic) content by separate Web servers, i.e.:
 - ❖ `http://images.example.com`
 - ❖ `http://www.example.com`
- using different domain names and/or computers to separate big files from small and medium sized files; the idea is to be able to fully cache small and medium sized files and to efficiently serve big or huge (over 10 - 1000 MB) files by using different settings;
- using many Web servers (programs) per computer, each one bound to its own network card and IP address;
- using many Web servers (computers) that are grouped together so that they act or are seen as one big Web server (see also Load balancer);
- adding more hardware resources (i.e. RAM, disks) to each computer;
- tuning OS parameters for hardware capabilities and usage;

Notes

- using more efficient computer programs for Web servers, etc.;
- using other workarounds, especially if dynamic content is involved.

14.1.8 Market Structure

Market share of major Web servers For more details on HTTP server programs, see Category:Web server software.

Below is the most recent statistics of the market share of the top web servers on the internet by [Netcraft](#) survey in November 2010.

Vendor	Product	Web Sites Hosted	Percent
Apache	Apache	148,085,963	59.36%
Microsoft	IIS	56,637,980	22.70%
Igor Sysoev	nginx	15,058,114	6.04%
Google	GWS	14,827,157	5.94%
lighttpd	lighttpd	2,070,300	0.83%

14.2 E-mail

Electronic mail, commonly called **email**, **e-mail** or **e.mail**, is a method of exchanging digital messages from an author to one or more recipients. Modern email operates across the Internet or other computer networks. Some early email systems required that the author and the recipient both be online at the same time, a la instant messaging. Today’s email systems are based on a store-and-forward model. Email servers accept, forward, deliver and store messages. Neither the users nor their computers are required to be online simultaneously; they need connect only briefly, typically to an email server, for as long as it takes to send or receive messages.

An email message consists of three components, the message envelope, the message header, and the message body. The message header contains control information, including, minimally, an originator’s email address and one or more recipient addresses. Usually descriptive information is also added, such as a subject header field and a message submission date/ time stamp.

Originally a text only (7 bit ASCII and others) communications medium, email was extended to carry multi-media content attachments, a process standardized in RFC 2045 through 2049. Collectively, these RFCs have come to be called Multipurpose Internet Mail Extensions (MIME).

The history of modern, global Internet email services reaches back to the early ARPANET. Standards for encoding email messages were proposed as early as 1973 (RFC 561). Conversion from ARPANET to the Internet in the early 1980s produced the core of the current services. An email sent in the early 1970s looks quite similar to a basic text message sent on the Internet today.

Network-based email was initially exchanged on the ARPANET in extensions to the File Transfer Protocol (FTP), but is now carried by the Simple Mail Transfer Protocol (SMTP), first published as Internet standard 10 (RFC 821) in 1982. In the process of transporting email messages between systems, SMTP communicates delivery parameters using a message envelope separate from the message (header and body) itself.

14.3 Instant Messaging (IM)

Notes

Instant messaging (IM) is a form of real-time direct text-based communication between two or more people using personal computers or other devices, along with shared clients. The user's text is conveyed over a network, such as the Internet. More advanced instant messaging software clients also allow enhanced modes of communication, such as live voice or video calling.

14.4 Internet Telephony

A category of hardware and software that enables people to use the Internet as the transmission medium for telephone calls. For users who have free or fixed-price Internet access, Internet telephony software essentially provides free telephone calls anywhere in the world. To date, however, Internet telephony does not offer the same quality of telephone service as direct telephone connections.

There are many Internet telephony applications available. Some, like CoolTalk and NetMeeting, come bundled with popular Web browsers. Others are stand-alone products. Internet telephony products are sometimes called *IP telephony*, *Voice over the Internet (VOI)* or *Voice over IP (VOIP)* products.

14.5 Videoconference

A **videoconference** or **video conference** (also known as a *videoteleconference*) is a set of interactive telecommunication technologies which allow two or more locations to interact via two-way video and audio transmissions simultaneously. It has also been called 'visual collaboration' and is a type of groupware.

Videoconferencing differs from videophone calls in that it is designed to serve a conference rather than individuals. It is an intermediate form of videotelephony, first deployed commercially by AT&T during the early 1970s using their Picturephone technology.

The core technology used in a videoconferencing system is digital compression of audio and video streams in real time. The hardware or software that performs compression is called a codec (coder/decoder). Compression rates of up to 1:500 can be achieved. The resulting digital stream of 1s and 0s is subdivided into labeled packets, which are then transmitted through a digital network of some kind (usually ISDN or IP). The use of audio modems in the transmission line allow for the use of POTS, or the Plain Old Telephone System, in some low-speed applications, such as videotelephony, because they convert the digital pulses to/from analog waves in the audio spectrum range.

The other components required for a videoconferencing system include:

- **Video input:** video camera or webcam
- **Video output:** computer monitor, television or projector
- **Audio input:** microphones, CD/DVD player, cassette player, or any other source of PreAmp audio outlet.
- **Audio output:** usually loudspeakers associated with the display device or telephone
- **Data transfer:** analog or digital telephone network, LAN or Internet

There are basically two kinds of videoconferencing systems:

1. **Dedicated systems** have all required components packaged into a single piece of equipment, usually a console with a high quality remote controlled video camera.

Notes

These cameras can be controlled at a distance to pan left and right, tilt up and down, and zoom. They became known as PTZ cameras. The console contains all electrical interfaces, the control computer, and the software or hardware-based codec. Omnidirectional microphones are connected to the console, as well as a TV monitor with loudspeakers and/or a video projector. There are several types of dedicated videoconferencing devices:

- (i) Large group videoconferencing are non-portable, large, more expensive devices used for large rooms and auditoriums.
- (ii) Small group videoconferencing are non-portable or portable, smaller, less expensive devices used for small meeting rooms.
- (iii) Individual videoconferencing are usually portable devices, meant for single users, have fixed cameras, microphones and loudspeakers integrated into the console.

2. **Desktop systems** are add-ons (hardware boards, usually) to normal PCs, transforming them into videoconferencing devices. A range of different cameras and microphones can be used with the board, which contains the necessary codec and transmission interfaces. Most of the desktops systems work with the H.323 standard. Videoconferences carried out via dispersed PCs are also known as e-meetings.

14.5.1 Conferencing Layers

The components within a Conferencing System can be divided up into several different layers: User Interface, Conference Control, Control or Signal Plane and Media Plane.

Video Conferencing User Interfaces could either be graphical or voice responsive. Many of us have encountered both types of interfaces, normally we encounter graphical interfaces on the computer or television, and Voice Responsive we normally get on the phone, where we are told to select a number of choices by either saying it or pressing a number. User interfaces for conferencing have a number of different uses; it could be used for scheduling, setup, and making the call. Through the User Interface the administrator is able to control the other three layers of the system.

Conference Control performs resource allocation, management and routing. This layer along with the User Interface creates meetings (scheduled or unscheduled) or adds and removes participants from a conference.

Control (Signaling) Plane contains the stacks that signal different endpoints to create a call and/or a conference. Signals can be, but aren't limited to, H.323 and Session Initiation Protocol (SIP) Protocols. These signals control incoming and outgoing connections as well as session parameters.

The Media Plane controls the audio and video mixing and streaming. This layer manages Real-Time Transport Protocols, User Datagram Packets (UDP) and Real-Time Transport Control Protocols (RTCP). The RTP and UDP normally carry information such the payload type which is the type of codec, frame rate, video size and many others. RTCP on the other hand acts as a quality control Protocol for detecting errors during streaming.

14.5.2 Multipoint Videoconferencing

Simultaneous videoconferencing among three or more remote points is possible by means of a Multipoint Control Unit (MCU). This is a bridge that interconnects calls from several sources (in a similar way to the audio conference call). All parties call the MCU unit, or the MCU unit can also call the parties which are going to participate, in sequence. There are MCU bridges for IP and ISDN-based videoconferencing. There are MCUs which are pure software, and others which are a combination of hardware and software. An MCU is characterised according to the number of simultaneous calls it can handle, its ability to

conduct transposing of data rates and protocols, and features such as Continuous Presence, in which multiple parties can be seen on-screen at once. MCUs can be stand-alone hardware devices, or they can be embedded into dedicated videoconferencing units.

The MCU consists of two logical components:

1. A single multipoint controller (MC), and
2. Multipoint Processors (MP), sometimes referred to as the mixer.

The MC controls the conferencing while it is active on the signaling plane, which is simply where the system manages conferencing creation, endpoint signaling and in-conferencing controls. This component negotiates parameters with every endpoint in the network and controls conferencing resources. While the MC controls resources and signaling negotiations, the MP operates on the media plane and receives media from each endpoint. The MP generates output streams from each endpoint and redirects the information to other endpoints in the conference.

Some systems are capable of multipoint conferencing with no MCU, stand-alone, embedded or otherwise. These use a standards-based H.323 technique known as “decentralized multipoint”, where each station in a multipoint call exchanges video and audio directly with the other stations with no central “manager” or other bottleneck. The advantages of this technique are that the video and audio will generally be of higher quality because they don’t have to be relayed through a central point. Also, users can make ad-hoc multipoint calls without any concern for the availability or control of an MCU. This added convenience and quality comes at the expense of some increased network bandwidth, because every station must transmit to every other station directly.

14.5.3 Videoconferencing Modes

Videoconferencing systems have several common operating modes that are used:

1. Voice-Activated Switch (VAS);
2. Continuous Presence.

In VAS mode, the MCU switches which endpoint can be seen by the other endpoints by the levels of one’s voice. If there are four people in a conference, the only one that will be seen in the conference is the site which is talking; the location with the loudest voice will be seen by the other participants.

Continuous Presence mode display multiple participants at the same time. The MP in this mode puts together the streams from the different endpoints and puts them all together into a single video image. In this mode, the MCU normally sends the same type of images to all participants. Typically these types of images are called “layouts” and can vary depending on the number of participants in a conference.

14.5.4 Echo Cancellation

A fundamental feature of professional videoconferencing systems is Acoustic Echo Cancellation (AEC). Echo can be defined as the reflected source wave interference with new wave created by source. AEC is an algorithm which is able to detect when sounds or utterances reenter the audio input of the videoconferencing codec, which came from the audio output of the same system, after some time delay. If unchecked, this can lead to several problems including:

1. the remote party hearing their own voice coming back at them (usually significantly delayed)
2. strong reverberation, rendering the voice channel useless as it becomes hard to understand and

Notes

3. howling created by feedback. Echo cancellation is a processor-intensive task that usually works over a narrow range of sound delays.

14.5.5 Problems

Some observers argue that three outstanding issues have prevented videoconferencing from becoming a standard form of communication, despite the ubiquity of videoconferencing-capable systems. These issues are:

1. **Eye Contact:** Eye contact plays a large role in conversational turn-taking, perceived attention and intent, and other aspects of group communication. While traditional telephone conversations give no eye contact cues, many videoconferencing systems are arguably worse in that they provide an incorrect impression that the remote interlocutor is avoiding eye contact. Some telepresence systems have cameras located in the screens that reduce the amount of parallax observed by the users. This issue is also being addressed through research that generates a synthetic image with eye contact using stereo reconstruction.

Telcordia Technologies, formerly Bell Communications Research, owns a patent for eye-to-eye videoconferencing using rear projection screens with the video camera behind it, evolved from a 1960s U.S. military system that provided videoconferencing services between the White House and various other government and military facilities. This technique eliminates the need for special cameras or image processing.

2. **Appearance Consciousness:** A second psychological problem with videoconferencing is being on camera, with the video stream possibly even being recorded. The burden of presenting an acceptable on-screen appearance is not present in audio-only communication. Early studies by Alphonse Chapanis found that the addition of video actually impaired communication, possibly because of the consciousness of being on camera.
3. **Signal latency:** The information transport of digital signals in many steps need time. In a telecommunicated conversation, an increased latency larger than about 150-300 ms becomes noticeable and is soon observed as unnatural and distracting. Therefore, next to a **stable large bandwidth**, a small total round-trip time is another major technical requirement for the communication channel for interactive videoconferencing.

The issue of eye-contact may be solved with advancing technology, and presumably the issue of appearance consciousness will fade as people become accustomed to videoconferencing.



Case Study

Success Story of Web Servers

In 1989 Tim Berners-Lee proposed to his employer CERN (European Organization for Nuclear Research) a new project, which had the goal of easing the exchange of information between scientists by using a hypertext system. As a result of the implementation of this project, in 1990 Berners-Lee wrote two programs:

- a browser called World Wide Web;
- the world's first web server, later known as CERN httpd, which ran on NeXTSTEP.

Between 1991 and 1994 the simplicity and effectiveness of early technologies used to surf and exchange data through the World Wide Web helped to port them to many different operating systems and spread their use among lots of different social groups of people, first in scientific organizations, then in universities and finally in industry.

Figure 14.1: The World's First Web Server



In 1994 Tim Berners-Lee decided to constitute the World Wide Web Consortium (W3C) to regulate the further development of the many technologies involved (HTTP, HTML, etc.) through a standardization process.

Questions:

1. Who is the founder of Web server?
2. Explain the web server.

14.6 Summary

- The Web server have such feature like Web sorting, Web working.
- A Web server can be referred to as other the hardware (the computer) or the software that helps to deliver content.
- Internet telephony use in web server.
- E-mail application is used Web Server.
- Videoconferencing differs from video phone calls in that it is designed to save a conference rather than individuals.
- The hardware or software that performs compression is called a codec (coder/decoder).

14.7 Keywords

E-mail: Electronic mail, commonly called email, is a method of exchanging digital messages from an author to one or more recipients.

Instant Messaging (IM): Instant messaging is a form of real time direct text based communication between two or more people using personal computers or other devices, along with shared elients.

Internet Telephony: It is a category of hardware and software that enables people to use the Internet as the transmission medium for telephone calls.

Notes

Multipoint Control Unit (MCU): Simultaneous videoconferencing among three or more remote points is possible by means of a Multipoint Control Unit (MCU).

Video Conference: A video conference is a set of interactive telecommunication technologies which allow two or more locations to interact via two way video and audio transmissions simultaneously.

Web server: A **web server** can be referred to as either the hardware (the computer) or the software (the computer application) that helps to deliver content that can be accessed through the Internet.

Web site: A Web site is a related collection of World Wide Web (WWW) files that includes a beginning file called a home page.



Lab Exercise

1. Explain video teleconference.
2. Explain Website.

14.8 Self-Assessment Questions

1. To browse general topics, we use:
 - (a) Subject guides
 - (b) Search engine
 - (c) Websites
 - (d) Web browsers
2. To get specific information, we use:
 - (a) Subject guides
 - (b) Search engine
 - (c) Websites
 - (d) Web browsers
3. The speed of a web server is faster in
 - (a) User-mode
 - (b) Kernel-mode
 - (c) Both of these
 - (d) None of these
4. What are the main cause of overload on web server?
 - (a) Computer worms
 - (b) XSS viruses
 - (c) Internet bots
 - (d) All of these
5. What is not a component of multipoint video conferencing?
 - (a) Multipoint controller (MC)
 - (b) Multipoint processor (MP)
 - (c) Video input
 - (d) Textual information

14.9 Review Questions

1. How can you download a particular information from the web?
2. What are the common features of a Web server?
3. Explain the difference between user-mode and kernel-mode web servers?
4. What are the anti-overload techniques used in web servers?
5. Explain significance of video conference and how it is used.

Answers for Self-Assessment Questions

Notes

1. (b) 2. (c) 3. (b) 4. (d) 5. (d)

14.10 Further Reading



Books

Excellence in Computer Education by Dr. C. K. Seth.



Online link

www.webopedia.com/index.php/TERM/I/internet.html



Accredited with NAAC **A** Grade
12-B Status from UGC



Address: N.H.-9, Delhi Road, Moradabad - 244001, Uttar Pradesh



Admission Helpline No. : 1800-270-1490



Contact No. : + 91 9520 942111



Email : university@tmu.ac.in